

*FRENIC-Multi*



# DeviceNet Interface Option "OPC-E1-DEV"

---

## **CAUTION**

Thank you for purchasing our DeviceNet Interface Option OPC-E1-DEV.

- This product is designed to connect the FRENIC-Multi series of inverters to DeviceNet. Read through this instruction manual and be familiar with the handling procedure for correct use.
- Improper handling blocks correct operation or causes a short life or failure.
- Deliver this manual to the end user of the product. The end user should keep this manual in a safe place until the DeviceNet Interface Option is discarded.
- For the usage of inverters, refer to the instruction manual prepared for the FRENIC-Multi series of inverters.

Copyright © 2006 Fuji Electric FA Components & Systems Co., Ltd.

All rights reserved.

No part of this publication may be reproduced or copied without prior written permission from Fuji Electric FA Components & Systems Co., Ltd.

All products and company names mentioned in this manual are trademarks or registered trademarks of their respective holders.

The information contained herein is subject to change without prior notice for improvement.

## Preface

Thank you for purchasing our DeviceNet Interface Option OPC-E1-DEV.

Mounting this option on your FRENIC-Multi allows you to connect the FRENIC-Multi to a DeviceNet master unit (e.g., PC and PLC) and control it as a slave unit using the run command, speed command, and access to function codes.

This option has the following features:

- Data Rate (baud rate): 125 kbps, 250 kbps, 500 kbps
- I/O Message: Polling and Change of State supported
- Applicable Profile: AC Drive profile
- Reading and writing all the function codes applicable to the FRENIC-Multi (User Defined Assembly I/O or Explicit Message)

This product has been tested by ODVA authorized Independent Test Lab and found to comply with ODVA's DeviceNet Conformance Test Version 18.

Certification Logo Mark: 

DeviceNet™ is a trademark of Open DeviceNet Vendor Association, Inc. (ODVA).

This instruction manual does not contain inverter handling instructions. Read through this instruction manual in conjunction with the FRENIC-Multi Instruction Manual (INR-SI47-1204-E) and be familiar with proper handling and operation of this product. Improper handling might result in incorrect operation, a short life, or even a failure of this product.

Keep this manual in a safe place.

### Related Publications

Listed below are the other materials related to the use of the DeviceNet interface option "OPC-E1-DEV." Read them in conjunction with this manual as necessary.



- RS-485 Communication User's Manual (MEH448)
- FRENIC-Multi Instruction Manual (INR-SI47-1204-E)

The materials are subject to change without notice. Be sure to obtain the latest editions for use.

### ■ Safety precautions

Read this manual thoroughly before proceeding with installation, connections (wiring), operation, or maintenance and inspection. Ensure you have sound knowledge of the device and familiarize yourself with all safety information and precautions before proceeding to operate the inverter.

Safety precautions are classified into the following two categories in this manual.

 <b>WARNING</b>	Failure to heed the information indicated by this symbol may lead to dangerous conditions, possibly resulting in death or serious bodily injuries.
 <b>CAUTION</b>	Failure to heed the information indicated by this symbol may lead to dangerous conditions, possibly resulting in minor or light bodily injuries and/or substantial property damage.

Failure to heed the information contained under the CAUTION title can also result in serious consequences. These safety precautions are of utmost importance and must be observed at all times.

## Installation and wiring

### **WARNING**

- Turn the inverter's power OFF and wait for at least five minutes. Further, check that the DC link bus voltage between the P (+) and N (-) terminals is lower than 25 VDC.
- Qualified electricians should carry out wiring.  
**Otherwise, electric shock could occur.**

### **CAUTION**

- Do not use the product that is damaged or lacking parts.  
**Doing so could cause a fire, accident, or injury.**
- Prevent lint, paper fibers, sawdust, dust, metallic chips, or other foreign materials from getting into the inverter and the option.  
**Otherwise, a fire or an accident might result.**
- Incorrect handling in installation/removal jobs could cause a failure.  
**A failure might result.**
- Noise may be emitted from the inverter, motor and wires. Implement appropriate measure to prevent the nearby sensors and devices from malfunctioning due to such noise.  
**Otherwise, an accident could occur.**

## Operation

### **WARNING**

- Be sure to install the terminal block cover, front cover of the inverter and option terminal cover before turning the inverter's power ON. Do not remove the covers while power is applied.  
**Otherwise electric shock could occur.**
- Do not operate switches with wet hands.  
**Doing so could cause electric shock.**
- If you set the function codes wrongly or without completely understanding FRENIC-Multi Instruction Manual (INR-SI47-1204-E) and the FRENIC-Multi User's Manual (MEH457), the motor may rotate with a torque or at a speed not permitted for the machine. Confirm and adjust the setting of the function codes before running the inverter.  
**Otherwise, an accident could occur.**

## Maintenance and inspection, and parts replacement

### **WARNING**

- Turn the inverter's power OFF and wait for at least five minutes before starting inspection. Further, check that the DC link bus voltage between the P (+) and N (-) terminals is lower than 25 VDC.  
**Otherwise, electric shock could occur.**
- Maintenance, inspection, and parts replacement should be made only by qualified persons.
- Take off the watch, rings and other metallic objects before starting work.
- Use insulated tools.  
**Otherwise, electric shock or injuries could occur.**

## Disposal

### CAUTION

- Treat the DeviceNet interface option as an industrial waste when disposing of it.  
**Otherwise injuries could occur.**

## Others

### WARNING

- Never attempt to modify the DeviceNet interface option.  
**Doing so could cause electric shock or injuries.**

## How this manual is organized

This manual is made up of chapters 1 through 12.

### **Chapter 1 BEFORE USING THIS OPTION**

Lists points to be checked upon delivery of this option. Also this chapter provides information on how to obtain an EDS file, and describes about applicable inverters.

### **Chapter 2 BASIC FUNCTIONS AND SETTINGS**

Provides inside view of this option and describes on how to specify the communication data rate (baud rate) and the node address on DeviceNet with the DIP switch. Also this chapter describes about LED status indicators.

### **Chapter 3 INSTALLATION OF THIS OPTION**

Provides instructions and precautions for mounting this option.

### **Chapter 4 WIRING AND CABLING**

Provides wiring instructions around the terminal blocks on this option and the cable specifications.

### **Chapter 5 CONFIGURING INVERTER'S FUNCTION CODES FOR DeviceNet COMMUNICATION**

Describes the inverter's function codes to be set for the DeviceNet communications link. Also this chapter lists the related function codes.

### **Chapter 6 ESTABLISHING A DeviceNet COMMUNICATIONS LINK**

Guides you to establish a DeviceNet communications link between the DeviceNet master and the inverter.

### **Chapter 7 I/O MESSAGE**

Provides overview of I/O Message and detailed descriptions of I/O assembly instances

### **Chapter 8 EXPLICIT MESSAGE**

Provides overview of Explicit Message and detailed descriptions of objects

### **Chapter 9 INVERTER REACTION TO DeviceNet COMMUNICATIONS ERRORS**

Describes on how the inverter operates if a DeviceNet communications error occurs.

### **Chapter 10 ALARM CODE LIST**

Lists and explains inverter's alarm codes.

### **Chapter 11 TROUBLESHOOTING**

Provides troubleshooting instructions for certain problems, e.g., when the inverter does not operate as ordered or when an alarm condition has been recognized.

### **Chapter 12 SPECIFICATIONS**

Lists the general specifications and communications specifications.

## Icons

The following icons are used throughout this manual.

 This icon indicates information which, if not heeded, can result in the product not operating to full efficiency, as well as information concerning incorrect operations and settings which can result in accidents.

 This icon indicates information that can prove handy when performing certain settings or operations.

 This icon indicates a reference to more detailed information.

## Table of Contents

Preface.....	1	Chapter 7	
How this manual is organized.....	3	I/O MESSAGE .....	19
Chapter 1		7.1 Overview .....	19
BEFORE USING THIS OPTION.....	5	7.2 I/O Assembly Instances: Selection and Setup .....	20
1.1 Acceptance Inspection .....	5	7.3 An Example of Actual I/O Communication Data.....	25
Chapter 2		7.4 I/O Assembly Instances Assigned to Word Variables (For reference) .....	27
BASIC FUNCTIONS AND SETTINGS .....	6	Chapter 8	
2.1 DeviceNet Interface Option Inside View .....	6	EXPLICIT MESSAGE .....	29
2.2 DIP Switch .....	6	8.1 Overview .....	29
2.3 LED Status Indicators.....	7	8.2 Objects to be Used in Explicit Message.....	29
2.4 RJ-45 Connector.....	8	8.3 Error Code List for Explicit Message Errors .....	35
2.5 Power Supply Terminal Block and DeviceNet Terminal Block.....	8	Chapter 9	
Chapter 3		INVERTER REACTION TO DeviceNet COMMUNICATIONS ERRORS .....	36
INSTALLATION OF THIS OPTION .....	9	Chapter 10	
Chapter 4		ALARM CODE LIST.....	38
WIRING AND CABLING .....	13	Chapter 11	
4.1 Basic Connection Diagram .....	13	TROUBLESHOOTING .....	39
4.2 Wiring for Power Supply Terminal Block .....	14	Chapter 12	
4.3 Wiring for DeviceNet Terminal Block	15	SPECIFICATIONS .....	40
4.4 Turning ON the Optional 24 V Power Supply.....	16	12.1 General Specifications .....	40
Chapter 5		12.2 DeviceNet Specifications.....	40
CONFIGURING INVERTER'S FUNCTION CODES FOR DeviceNet COMMUNICATION ....	17		
Chapter 6			
ESTABLISHING A DeviceNet COMMUNICATIONS LINK .....	18		

## Chapter 1 BEFORE USING THIS OPTION

### 1.1 Acceptance Inspection

Unpack the package and check the following:

- (1) A DeviceNet interface option and accessories below are contained in the package. (See Figure 1.1.)
  - Two option connection cables
    - One short cable: For inverters with a capacity of 5 HP or below
    - One long cable: For inverters with a capacity of 7.5 HP or above
  - One option fixing screw
  - DeviceNet Interface Option Instruction Manual (this manual)
- (2) The option and accessories have not been damaged during transportation—there should be no dents or parts missing.
- (3) The model name "OPC-E1-DEV" is printed on the nameplate attached to the right side of the option. (See Figure 1.1.)

If you suspect the product is not working properly or if you have any questions about your product, contact your Fuji Electric representative.

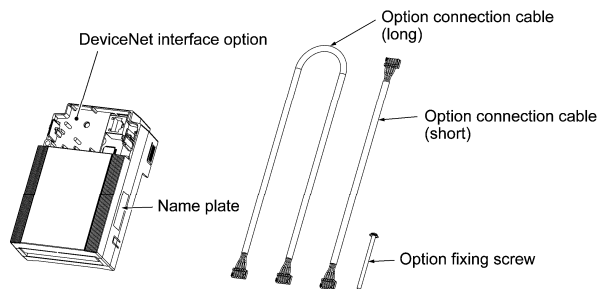

Figure 1.1 DeviceNet Interface Option and Accessories

**Note** Neither an EDS file nor a terminating resistor comes with this option.

- An EDS file is required for registering this option to the configurator for DeviceNet master node settings. It is available as a free download from our website at:  
<http://web1.fujielectric.co.jp/Kiki-Info-EN/User/index.html>  
(Fuji Electric FA Components & Systems Co., Ltd. Technical Information)  
Before downloading, you are requested to register as a member (free of charge).
- A terminating resistor of the following specifications must be used: 121 ohm  $\pm 1\%$ , 1/4 watt, metal-film resistor

## Chapter 2 BASIC FUNCTIONS AND SETTINGS

### 2.1 DeviceNet Interface Option Inside View

Figure 2.1 shows the inside view of the DeviceNet interface option with the option terminal cover (See Figure 3.3) removed.

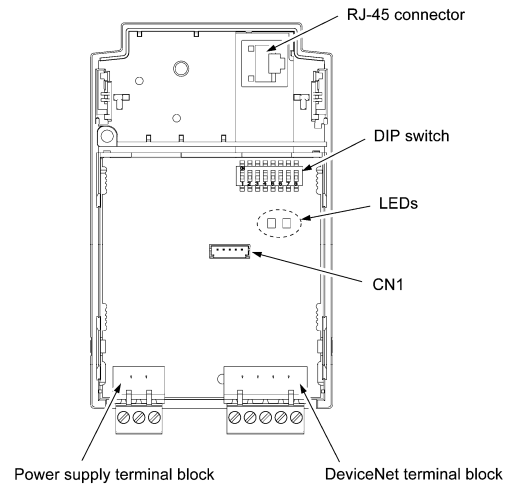

Figure 2.1 DeviceNet Interface Option Inside View

### 2.2 DIP Switch

The DIP switch specifies the communication data rate (baud rate) and the node address (MAC ID) on DeviceNet. It offers a choice of three baud rates (125 kbps, 250 kbps, and 500 kbps) and a choice of node address (MAC ID) ranging from 0 to 63.

**Note** Before accessing the DIP switch, make sure that both the inverter and the option are turned OFF. If you change the configuration of the DIP switch with the inverter and the option being ON, you need to restart both the inverter and the option to validate the new settings.

The default settings of the DIP switch at factory shipment are: data rate = 500 kbps, node address = 63.

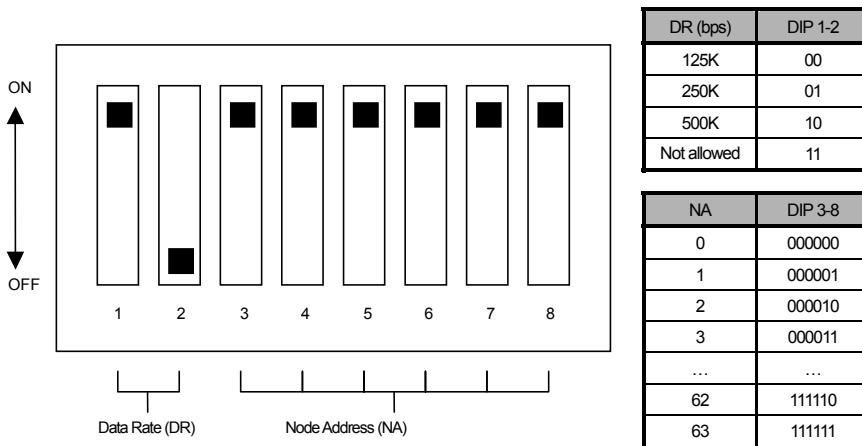

Figure 2.2 DIP Switch Settings (showing an example of Data Rate = 500 kbps and Node Address = 63)



## 2.3 LED Status Indicators

The two LED status indicators show the status of this option.



- MS (Module Status)  
Indicates the hardware status of the DeviceNet interface option.
- NS (Network Status)  
Indicates the communication status on DeviceNet.

The tables below show the states of the LEDs and their meanings.

Table 2.1 MS LED state

MS LED	Status	Meaning	Note
Blinks between green and red*1	Self-diagnostic test	Running self-diagnostic test upon power-on	This test takes 1 second.
OFF	Power OFF	Powered OFF	The inverter issues <i>er4</i> .
Lights in green	Hardware normal	Hardware working normally	–
Lights in red	Hardware error	Option not properly mounted or the option is faulty	The inverter issues <i>er4</i> .

Table 2.2 NS LED state

NS LED	Status	Meaning	Note
Blinks between green and red*1	Self-diagnostic test	Running self-diagnostic test upon power-on	This test takes 1 second.
OFF	Offline	DeviceNet being offline	–
Blinks in green	Online	DeviceNet cabling correct Option not communicating on the DeviceNet network	Waiting for a request from the master
Lights in green	Connection established	Option communicating normally on the DeviceNet network	–
Blinks in red	Connection timeout	Connection timeout between the option and the master - Too short communication cycle time	The inverter issues <i>er5</i> *2
Lights in red	Connection error	Improper DeviceNet cabling, or improper settings - Node address double assigned - Data rate mismatch - Bus-off state detected - Power supply cable for the DeviceNet unconnected - Improper wiring for the DeviceNet terminal block	The inverter issues <i>er5</i> *2

\*1 Blinks in the pattern specified in the DeviceNet specifications.

\*2 *er5* cannot be reset until the NS LED comes to stay on in green. A setting for ignoring *er5* is also available even if a connection error is detected. For details, refer to Chapter 9, Section 1 "INVERTER REACTION TO DeviceNet COMMUNICATIONS ERRORS."

## 2.4 RJ-45 Connector

The RJ-45 connector is used to connect the keypad of the FRENIC-Multi to this option.

 The keypad can be detached from the option and mounted on a panel wall. For details, refer to the FRENIC-Multi Instruction Manual (INR-SI47-1204-E), Chapter 2, Section 2.4 "Mounting and Connecting a Keypad."

## 2.5 Power Supply Terminal Block and DeviceNet Terminal Block

The power supply terminal block and DeviceNet terminal block are used to connect the 24V power cable and DeviceNet cable, respectively, in order to operate this option.

 For details, refer to Chapter 4 "WIRING AND CABLING."

### Chapter 3 INSTALLATION OF THIS OPTION

#### **WARNING**

Turn the inverter's power OFF and wait for at least five minutes. Further, check that the DC link bus voltage between the P (+) and N (-) terminals is lower than 25 VDC.

**Otherwise, electric shock could occur.**

#### **CAUTION**

- Do not use the product that is damaged or lacking parts.  
**Doing so could cause a fire, accident, or injury.**
- Prevent lint, paper fibers, sawdust, dust, metallic chips, or other foreign materials from getting into the inverter and the option.  
**Otherwise, a fire or an accident might result.**
- Incorrect handling in installation/removal jobs could cause a failure.  
**A failure might result.**

When handling this option, take any antistatic measure or hold the plastic parts taking care not to directly touch the circuit board; otherwise, the static electricity charged in your body may damage it.

**Note** Before mounting the option, perform the wiring for the main circuit terminals and control circuit terminals.

(1) Remove the terminal cover from the inverter.

**Note:** For inverters with a capacity of 7.5 to 20 HP, you need to remove the terminal cover fixing screw to remove the terminal cover.

 For details on how to remove the terminal cover, refer to the FRENIC-Multi Instruction Manual (INR-SI47-1204-E), Chapter 2, Section 2.3 "Wiring."

(2) Connect the option connection cable to the CN1 connector on the interface printed circuit board (interface PCB) on the inverter.

Use the short cable for inverters with a capacity of 5 HP or below, and the long cable for the ones with a capacity of 7.5 HP or above.

(3) Mount the terminal cover.

 For details on how to mount the terminal cover, refer to the FRENIC-Multi Instruction Manual (INR-SI47-1204-E), Chapter 2, Section 2.3 "Wiring."

(4) Push the hooks provided on both sides of the keypad and pull the keypad up and out of the inverter.

 For details on how to remove the keypad, refer to the FRENIC-Multi Instruction Manual (INR-SI47-1204-E), Chapter 2, Section 2.4 "Mounting and Connecting a Keypad."

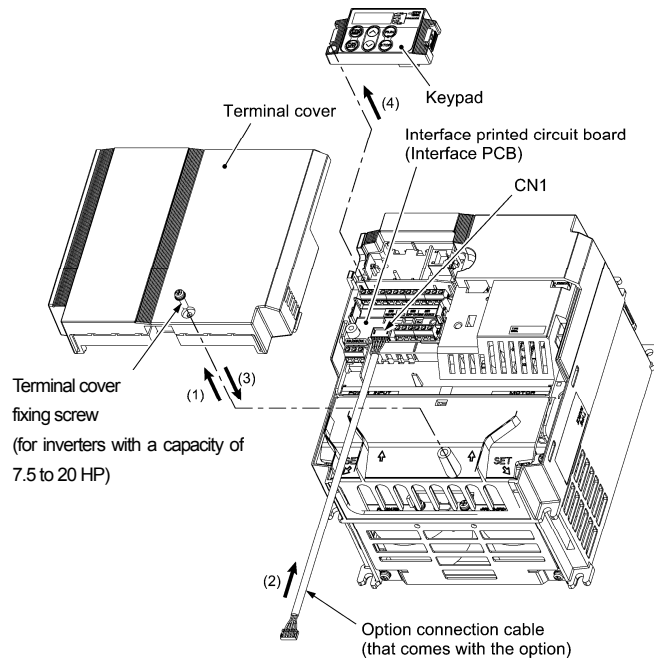

Figure 3.1 Connecting the Option Connection Cable to the Interface PCB and Removing the Keypad  
(For inverters with a capacity of 15 and 20 HP)

- (5) Mount the option on the inverter, making the RJ-45 connector on the back side of the option engage with the RJ-45 connector on the inverter (to which the keypad had been connected).
- (6) Connect the keypad to the RJ-45 connector on the front side of the option, then secure the keypad and option to the inverter with the option fixing screw (that comes with the option).

When using the keypad at a remote site, secure the option without the keypad to the inverter with the screw.

Tightening torque: 0.6 N·m(0.4 lbf·ft)

**Note** Take care not to tighten the option fixing screw too much. Doing so could make the screw defective.

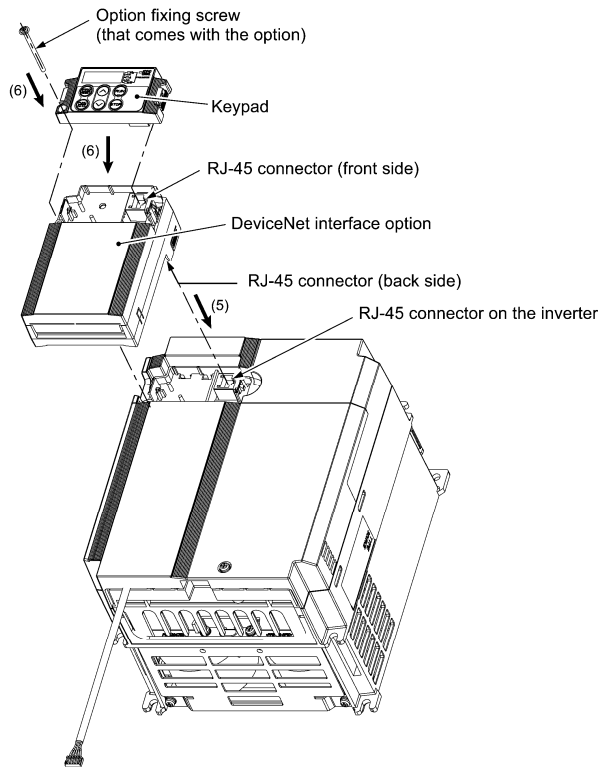

Figure 3.2 Mounting the DeviceNet Interface Option and the Keypad

- (7) Slightly pull the bottom of the option terminal cover towards you and remove it downward.
- (8) Connect the other end of the option connection cable (whose end has been connected to the interface PCB on the inverter in step (2) above) to the CN1 connector on the interface option printed circuit board (interface option PCB).
- (9) Mount the option terminal cover.  
First fit the bosses on the top of the cover into the square holes provided in the option, and then push the bottom of the cover until it snaps into place.

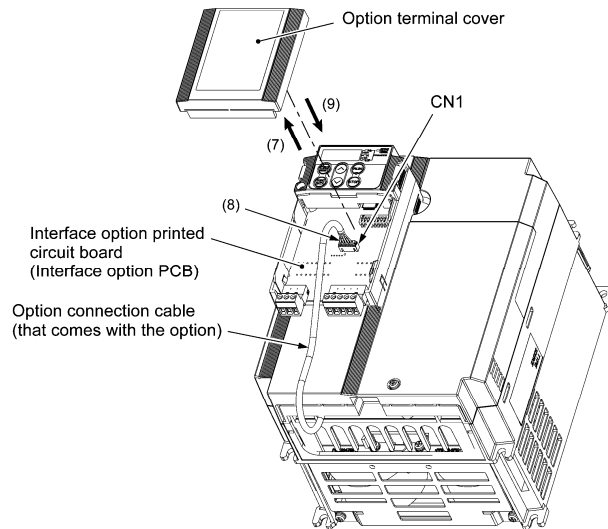

Figure 3.3 Connecting the Option Connection Cable to the Interface Option PCB

## Chapter 4 WIRING AND CABLING

### ⚠ WARNING

- Before starting installation, turn off the power to the inverter and wait for at least five minutes. Further, check the DC link circuit voltage between the P (+) and N (-) terminals to be lower than 25 VDC.
- Qualified electricians should carry out wiring.

**Otherwise, electric shock could occur.**

### ⚠ CAUTION

The inverter, motor, and wiring emit electrical noise. Take appropriate measures to prevent the nearby sensors and devices from malfunctioning due to such noise.

**Otherwise, an accident could occur.**

#### 4.1 Basic Connection Diagram

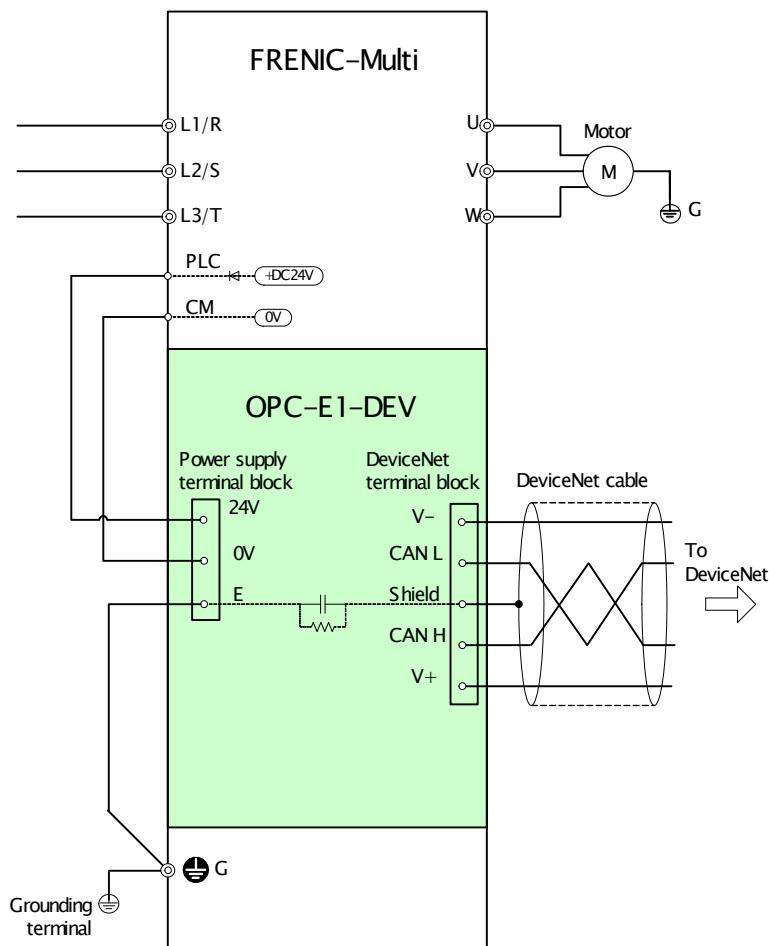

Figure 4.1 Basic Connection Diagram

## 4.2 Wiring for Power Supply Terminal Block

This terminal block is used to supply this option with 24 V power to operate it. Perform wiring for the terminal block as described below.

### (1) Wiring for the power supply terminal block (TERM3)

The terminal block uses a pluggable 3-pin connector as shown in Figure 4.2. Table 4.1 shows the pin assignment.

A typical connector that matches this terminal block is Phoenix Contact MSTB 2.5/3-ST-5.08.

Table 4.1 Pin Assignment on Power Supply Terminal Block

Pin #	Terminal name	Description	Remarks
1	24V	Power supply (24 VDC, + side)	The PLC terminal of the FRENIC-Multi is available as a 24V power source. Connect the PLC terminal to this "24V" terminal and CM terminal to this "0V" terminal.
2	0V	Power supply (24 VDC, - side)	
3	E	Grounding terminal	Connect the ground terminal of the inverter (⊕G) to this terminal.

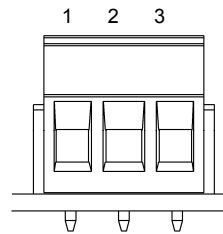

Figure 4.2 Connectors on the Power Supply Terminal Block

**Note** For protection against external noise and prevention of failures, be sure to connect a grounding wire.

Table 4.2 lists the recommended wire size, terminal screw size and its tightening torque.

Table 4.2 Recommended Wire Size, Terminal Screw Size, and Its Tightening Torque for the Power Supply Terminal Block

Wire size	Terminal screw size	Tightening torque
AWG20 to AWG16 (0.5 to 1.5mm <sup>2</sup> ), wire with rated temperature 105 °C(221 °F) (UL) recommended	M3	0.5 to 0.6 N·m (0.37 to 0.44 lbf·ft)

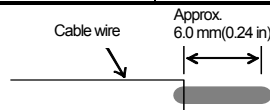

Figure 4.3 Recommended Strip Length of the Cable Wire End for Terminal Connection



(2) Input power requirements

It is recommended that the PLC and CM terminals on the FRENIC-Multi be used for the power supply terminal block. When using an external power source, however, select the input power supply that meets the specifications listed in Table 4.3.

Table 4.3 Input Power Requirements

Item	Specifications
Input power voltage range	21.6 to 27.0 V
Power consumption	Maximum 35 mA

**Note** Do not use the 24 V power supply designed for DeviceNet communication (i.e., power supply fed to the DeviceNet cable) for the power supply terminal block. Doing so may affect negatively on the noise resistance in DeviceNet communication.

**Tip** It is convenient to use the PLC terminal on the control circuit terminal block on the FRENIC-Multi as a 24 V power supply. Connect the PLC terminal to the "24 V" terminal of this option, and the CM terminal, to the "0 V" terminal.

For details about the PLC and CM terminals, refer to the FRENIC-Multi Instruction Manual (INR-SI47-1204-E), Chapter 2, Section 2.3 "Wiring."

### 4.3 Wiring for DeviceNet Terminal Block

(1) To connect this option to DeviceNet, use a DeviceNet thin cable complying with the DeviceNet specifications. Also observe the wiring lengths specified in the DeviceNet specifications.

**Tip** The recommended DeviceNet cable is TDN24U made by SWCC Showa Device Technology, Co., Ltd.

Proper installation of the cable requires specialist knowledge. Be sure to refer to the DeviceNet specifications (published by ODVA) beforehand.

(2) Wiring around the DeviceNet terminal block (TERM1)

The terminal block uses a pluggable 5-pin connector as shown in Figure 4.4. It has five labels corresponding to the five pins. Each label has an ID color corresponding to the wire (core) to be connected to its pin. Make sure that the ID colors of the wires and labels match. Table 4.4 shows the correspondence between the pin numbers and the ID colors.

A typical connector that matches this terminal block is Phoenix Contact MSTB 2.5/5-ST-5.08 AU.

**Tip** The Phoenix Contact TMSTBP 2.5/5-ST-5.08 AU and TFKC 2.5/5-STF-5.08 AU (spring-cage connection type) connectors for multidrop connection are also usable. Note that, however, the former can be used only for FRENIC-Multi 5 HP or below.

Table 4.4 Layout of Terminal Pins

Pin #	ID Color of Wire Sheath	Pin Assignment	Description
1	Black	V-	Power supply (24 VDC, - side)
2	Blue	CANL	Signal line (- side)
3	Metallic	SD	Cable shield
4	White	CANH	Signal line (+ side)
5	Red	V+	Power supply (24 VDC, + side)

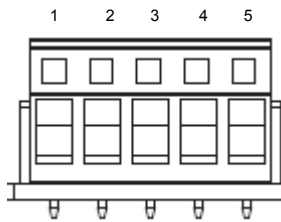

Figure 4.4 Connectors on the DeviceNet Terminal Block

Table 4.5 lists the recommended terminal screw size and its tightening torque, and Figure 4.5 shows the recommended strip length of the cable wire end.

Table 4.5 Recommended Tightening Torque of the Terminal Screws for the DeviceNet Terminal Block

Terminal screw size	Tightening torque
M3	0.5 to 0.6 N·m (0.37 to 0.44 lbf·ft)

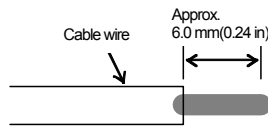

Figure 4.5 Recommended Strip Length of the Cable Wire End for Terminal Connection

### (3) Terminating resistor

DeviceNet requires a terminating resistor to be installed externally on each end of the trunk line. Check that the trunk line is terminated on both ends; if not, install a terminating resistor(s) on the missing end(s).

**Note** Terminating resistors do not come with this option. A pair of resistors with the following specifications is separately necessary.  
121 ohm  $\pm 1\%$ , 1/4 watt, metal-film resistor

## 4.4 Turning ON the Optional 24 V Power Supply

Observe the following instructions about the ON/OFF timing of this option and the inverter.

### (1) Power ON

It is recommended that this option be turned ON at the same time as or before the inverter. Turning the inverter ON first may detect no operation of the option, causing a trip with *er4* alarm. The *er4* trip can be reset after this option is turned ON.

### (2) Power OFF

It is recommended that this option be turned OFF at the same time as or after the inverter. Turning the option OFF first may cause the inverter to detect no operation of the option, causing a trip with *er4* alarm. Turning the inverter OFF resets the *er4* trip.

**Tip** When the PLC terminal on the FRENIC-Multi control circuit terminal block is used as a 24V power source, turning ON or OFF of the inverter interlocks with that of the option. It is convenient.

## Chapter 5 CONFIGURING INVERTER'S FUNCTION CODES FOR DeviceNet COMMUNICATION

Before starting DeviceNet communication between the inverter equipped with this option and the DeviceNet master device, configure the inverter's function codes listed in Table 5.1.

Table 5.2 lists other related function codes to be configured if necessary.

Table 5.1 Inverter's Function Codes for DeviceNet Communication

Function codes	Description	Factory default setting	Function code data	Remarks															
o31 1 *	Select output assembly instance (From master to slave)	0	Available data is: 20 : Basic speed control output 0, 21: Extended speed control output 100 : Fuji drive assembly output 102 : User defined assembly output	See Chapter 7. The factory default is "Extended speed control output."															
o32 1 *	Select input assembly instance (From slave to master)	0	Available data is: 70 : Basic speed control input 0, 71: Extended speed control input 101 : Fuji drive assembly input 103 : User defined assembly input	See Chapter 7. The factory default is "Extended speed control input."															
y98 2 *	Select run/frequency command source	0	Available data is: <table border="1" style="margin-left: 20px;"> <thead> <tr> <th></th> <th>Frequency command</th> <th>Run command</th> </tr> </thead> <tbody> <tr> <td>0</td> <td>Inverter</td> <td>Inverter</td> </tr> <tr> <td>1</td> <td>DeviceNet</td> <td>Inverter</td> </tr> <tr> <td>2</td> <td>Inverter</td> <td>DeviceNet</td> </tr> <tr> <td>3</td> <td>DeviceNet</td> <td>DeviceNet</td> </tr> </tbody> </table>		Frequency command	Run command	0	Inverter	Inverter	1	DeviceNet	Inverter	2	Inverter	DeviceNet	3	DeviceNet	DeviceNet	If there is no special problem with your system, setting y98 = 3 is recommended.
	Frequency command	Run command																	
0	Inverter	Inverter																	
1	DeviceNet	Inverter																	
2	Inverter	DeviceNet																	
3	DeviceNet	DeviceNet																	

\*1 After configuring the function code o31 or o32, turn the power of the inverter and the option OFF and then ON to validate the new setting. For details about these functions, refer to Chapter 7 "I/O MESSAGE."

Input and output assembly instances should not be necessarily set to the same instance type. (Ex. Output assembly instance = Extended speed control output, Input assembly instance = User defined assembly input.)

\*2 If the extended speed control input/output is selected (o31 = 0 or 21), bit operation in the instance can select the run/frequency command source, requiring no prior configuration of y98. For details, refer to Chapter 7, Section 7.2 "(2) Extended Speed Control Instance."

Table 5.2 Other Related Function Codes

Function codes	Description	Factory default setting	Function code setting range	Remarks
o27 *1	Select the inverter's operation mode to apply when a DeviceNet communications error occurs.	0	0 to 15	
o28 *1	Set the operation timer to apply when a DeviceNet communications error occurs.	0.0 s	0.0 to 60.0 s	
o40 to o43 *2	Assign the function code writing data cyclically.	0 (No assignment)	0000 to FFFF (hex)	Valid only when "User defined assembly input/output" is selected (o31 = 102, o32 = 103).
o48 to o51 *2	Assign the function code reading data cyclically.	0 (No assignment)	0000 to FFFF (hex)	

\*1 For details about function codes o27 and o28, refer to Chapter 9 "INVERTER REACTION TO DeviceNet COMMUNICATIONS ERRORS."

\*2 For details about function codes o40 to o43 and o48 to o51, refer to Chapter 7, Section 7.2 (4) "User Defined Assembly Instance."

## Chapter 6 ESTABLISHING A DeviceNet COMMUNICATIONS LINK

This chapter guides you to establish a DeviceNet communications link in I/O Message transmission between the DeviceNet master and the inverter (slave).

 I/O Message is a communication process that cyclically transfers data between the DeviceNet master and slave. For details about I/O Message, refer to Chapter 7, "I/O MESSAGE."

- (1) Configure the inverter's function codes described in Chapter 5.
  - Set the I/O assembly instances with the inverter's function codes o31 and o32. It is not necessary to set the same type of I/O assembly instances to input and output.
  - Configure the inverter's function codes o27 and o28 with your need. If the instances for user defined assemblies have been set, configure the function codes o40 to o43 and o48 to o51.
  - After completion of the settings above, restart the inverter and this option in order to validate the settings.

 For details about the inverter's function codes o31, o32, o40 to o43, and o48 to o51, refer to Chapter 7 "I/O MESSAGE."

- (2) Set up the DeviceNet master (PLC, PC tool, or Configurator).
  - Set a unique MAC ID (node address), so that it does not coincide with any other nodes.
  - Set the baud rate. Make sure that all the nodes have the same baud rate.
  - If necessary, install the EDS file of this option to the setup tool of the master.
  - Allocate an I/O area corresponding to the I/O assembly instance set for this option. The I/O area is either 2 words or 4 words in length.
  - Specify the I/O connection type—"Poll" or "Change of state." Specify the communications scan cycle if necessary.

 **Note** The communications scan cycle to this option should be 10 ms or longer. If a single slave is connected to a master, the cycle should be 10 ms or longer; if two slaves are connected, 5 ms or longer. To minimize the data conflicts and maximize the system reliability, the cycle of 20 ms or longer is recommended.

 **Tip** The Electric Data Sheet (EDS) file defines parameters on the slave. Using it quickly accesses the desired parameters. For this option, the file makes it easier to access the inverter's function codes. For how to obtain the EDS file, refer to Chapter 2 "Acceptance Inspection."

 For details about the setup procedure of the DeviceNet master, refer to the user's manual of the corresponding master.

- (3) Configure the node address and baud rate with the DIP switch on this option.
  - Before accessing the DIP switch, make sure that both the inverter and this option are turned OFF.
  - Set a unique node address, so that it does not coincide with any other nodes.
  - Set the same baud rate as the master.

 For details about setting the DIP switch, refer to Section 2.2 "DIP Switch."

- (4) Have an I/O connection request issued from the DeviceNet master.
  - Turn ON the inverter and this option.
  - Have an I/O connection request issued from the DeviceNet master.

 For details about issuing I/O connection requests from the master, refer to the user's manual of the connected master device. In many PLCs, an I/O connection request is automatically issued at the time of powering ON.

- (5) Start I/O Message.

If both the master and this option have been set correctly and the wiring is proper, I/O message connection will be established in response to the connection request and data transmission starts. At this stage, the MS and NS LEDs on this option light in green. It is ready to control the inverter according to the specified I/O assembly instances.

## Chapter 7 I/O MESSAGE

### 7.1 Overview

I/O Message is a communication process that cyclically transfers data between the DeviceNet master and slave.

This option supports two types of I/O Message connections—Poll and Change-of-State connections. It also supports four types of I/O assembly instances as data formats in I/O Message, as listed in Table 7.1. One of the four instances can be selected for input and output each.

The I/O assembly instances should be specified using inverter's function codes o31 and o32.



- Poll connections allow the master to periodically poll the slave for data. In response to the request, the slave sends data. In Change-of-State connections, the slave sends data only when the data has changed.
- Input and output assembly instances should not be necessarily set to the same instance type. (Ex. Output assembly instance = Extended speed control output, Input assembly instance = User defined assembly input.)

Table 7.1 Configuring I/O Assembly Instances

o31, o32	Type	Instance ID	Description	Length (words)
o31=20	Output (from master to slave)	20	Basic Speed Control Output	2
o31=0 or 21		21	Extended Speed Control Output (Factory default)	2
o31=100		100	Fuji Drive Assembly Output	2
o31=102		102	User Defined Assembly Output	4
o32=70	Input (from slave to master)	70	Basic Speed Control Input	2
o32=0 or 71		71	Extended Speed Control Input (Factory default)	2
o32=101		101	Fuji Drive Assembly Input	2
o32=103		103	User Defined Assembly Input	4

## 7.2 I/O Assembly Instances: Selection and Setup

### (1) Basic speed control instance

Output (from master to this option): o31=20

Instance	byte	bit 7	bit 6	bit 5	bit 4	bit 3	bit 2	bit 1	bit 0
20	0	-	-	-	-	-	Fault Reset	-	Run Forward
	1	(Fixed at 00)							
	2	Speed Reference (lower byte) (r/min)							
	3	Speed Reference (upper byte) (r/min)							

Run Forward: 1 = Run forward command

Fault Reset: 1 = Reset the alarm condition

Speed Reference: Speed command (in r/min)

Input (from this option to master): o32=70

Instance	byte	bit 7	bit 6	bit 5	bit 4	bit 3	bit 2	bit 1	bit 0
70	0	-	-	-	-	-	Running Forward	-	Faulted
	1	(Fixed at 00)							
	2	Speed Actual (lower byte) (r/min)							
	3	Speed Actual (upper byte) (r/min)							

Faulted: 1 = The inverter has (and remains) tripped

Running Forward: 1 = The motor is running forward.

Speed Actual: Actual rotation speed (in r/min)

(2) Extended Speed Control Instance (factory default)

Output (from master to this option): o31=0 or 21

Instance	byte	bit 7	bit 6	bit 5	bit 4	bit 3	bit 2	bit 1	bit 0
21	0	-	NetRef	NetCtrl	-	-	Fault Reset	Run Reverse	Run Forward
	1	(Fixed at 00)							
	2	Speed Reference (lower byte) (r/min)							
	3	Speed Reference (upper byte) (r/min)							

Run Forward: 1 = Run forward command

Run Reverse: 1 = Run reverse command

Fault Reset: 1 = Reset the alarm condition

NetCtrl: 1 = Request for enabling run command sent from DeviceNet;  
0 = Request for enabling run command sent from other than DeviceNet

NetRef: 1 = Request for enabling speed reference sent from DeviceNet;  
0 = Request for enabling speed reference sent from other than DeviceNet

Speed Reference: Speed reference (in r/min)

Input (from this option to master): o32=0 or 71

Instance	byte	bit 7	bit 6	bit 5	bit 4	bit 3	bit 2	bit 1	bit 0
71	0	At Reference	Ref FromNet	Ctrl FromNet	Ready	Running Reverse	Running Forward	-	Faulted
	1	Drive State							
	2	Speed Actual (lower byte) (r/min)							
	3	Speed Actual (upper byte) (r/min)							

Faulted: 1 = The inverter has (and remains) tripped.

Running Forward: 1 = The motor is running forward.

Running Reverse: 1 = The motor is running backward (in the reverse direction).

Ready: 1 = Ready to run

CtrlFromNet: 1 = Run command sent from DeviceNet being enabled  
0 = Run command sent from other than DeviceNet being enabled

RefFromNet: 1 = Speed reference sent from DeviceNet being enabled  
0 = Speed reference sent from other than DeviceNet being enabled

At Reference: 1 = The motor is running at the reference speed.

Drive State: 1 = Startup, 2 = Not Ready, 3 = Ready, 4 = Enabled, 5 = Stopping,  
6 = Fault stop, 7 = Faulted

Speed Actual: Actual rotation speed (in r/min)

(3) Fuji Drive Assembly Instance

Output (from master to this option): o31=100

Instance	byte	bit 7	bit 6	bit 5	bit 4	bit 3	bit 2	bit 1	bit 0
100	0	-	X5	X4	X3	X2	X1	REV	FWD
	1	RST	XR	XF	-	-	-	-	-
	2	Frequency command p.u. (lower byte)							
	3	Frequency command p.u. (upper byte)							

FWD: 1 = Run forward command

REV: 1 = Run reverse command

X1 to X5: Communication terminal block command  
(The function to be performed is specified by E01 to E05).

XF, XR: Communication terminal block command  
(The function to be performed is specified by E98 and E99).

RST: 1 = Reset the alarm (fault) condition.

Frequency command p.u.: Specifies the ratio of the frequency relative to the maximum frequency (defined by F03 in Hz) being assumed as 20000.  
Frequency command p.u. = Frequency command (Hz)/F03 (Hz) × 20000.

Input (from this option to master): o32=101

Instance	byte	bit 7	bit 6	bit 5	bit 4	bit 3	bit 2	bit 1	bit 0
101	0	VL	TL	NUV	BRK	INT	EXT	REV	FWD
	1	BUSY	ERR	-	RL	ALM	DEC	ACC	IL
	2	Frequency output p.u. (lower byte)							
	3	Frequency output p.u. (upper byte)							

FWD: During forward rotation

REV: During reverse rotation

EXT: During DC braking (or during pre-exciting)

INT: Inverter shut down

BRK: During braking

NUV: DC link bus voltage established (0 = undervoltage)

TL: During torque limiting

VL: During voltage limiting

IL: During current limiting

ACC: During acceleration

DEC: During deceleration

ALM: Alarm relay (for any fault)

RL: Run or speed command from communication enabled

ERR: Function code access error

BUSY: During function code data writing

Frequency output p.u.: Specifies the ratio of the frequency relative to the maximum frequency (defined by F03 in Hz) being assumed as 20000.



(4) User Defined Assembly Instance

Output (from master to this option): o31=102

User Defined Assembly Output offers a format which allows the user to freely set or modify the function code defined by the user using the function codes o40 to o43 beforehand. Four function codes are provided for the user to define.

Instance	byte	bit 7	bit 6	bit 5	bit 4	bit 3	bit 2	bit 1	bit 0
102	0	User-defined function code 1 (write) (lower byte) (data of function code specified by o40)							
	1	User-defined function code 1 (write) (upper byte) (data of function code specified by o40)							
	2	User-defined function code 2 (write) (lower byte) (data of function code specified by o41)							
	3	User-defined function code 2 (write) (upper byte) (data of function code specified by o41)							
	4	User-defined function code 3 (write) (lower byte) (data of function code specified by o42)							
	5	User-defined function code 3 (write) (upper byte) (data of function code specified by o42)							
	6	User-defined function code 4 (write) (lower byte) (data of function code specified by o43)							
	7	User-defined function code 4 (write) (upper byte) (data of function code specified by o43)							

User-defined function code 1 (write): Write data for the function code specified by o40

User-defined function code 2 (write): Write data for the function code specified by o41

User-defined function code 3 (write): Write data for the function code specified by o42

User-defined function code 4 (write): Write data for the function code specified by o43

**Note** If you assign the same function code to more than one "o" code, only the one with the smallest "o" code number will become effective, and all the rest will be ignored (treated as "not assigned").  
 (For example, if the same function code is assigned to o40 and o43, o40 becomes effective and o43 does not.)

 For details about configuring the inverter's function codes using o40 to o43, refer to the next page.

Input (from this option to master): o32=103

User Defined Assembly Input offers a format which allows the user to monitor the function codes defined by the user using the function codes o48 to o51 beforehand. Four function codes are provided for the user to define.

Instance	byte	bit 7	bit 6	bit 5	bit 4	bit 3	bit 2	bit 1	bit 0
103	0	User-defined function code 1 (read) (lower byte) (data of function code specified by o48)							
	1	User-defined function code 1 (read) (upper byte) (data of function code specified by o48)							
	2	User-defined function code 2 (read) (lower byte) (data of function code specified by o49)							
	3	User-defined function code 2 (read) (upper byte) (data of function code specified by o49)							
	4	User-defined function code 3 (read) (lower byte) (data of function code specified by o50)							
	5	User-defined function code 3 (read) (upper byte) (data of function code specified by o50)							
	6	User-defined function code 4 (read) (lower byte) (data of function code specified by o51)							
	7	User-defined function code 4 (read) (upper byte) (data of function code specified by o51)							

User-defined function code 1 (read): Monitored value of the function code specified by o48

User-defined function code 2 (read): Monitored value of the function code specified by o49

User-defined function code 3 (read): Monitored value e of the function code specified by o50

User-defined function code 4 (read): Monitored value of the function code specified by o51

 For details about configuring the inverter's function codes using o48 to o51, refer to the next page.

 Each function code defined has its own data format. For details about the data format of each code, refer to the RS-485 Communication Use's Manual (MEH448), Chapter 5, Section 5.2 "Data Formats."

**How to set o40 to o43 and o48 to o51**

Specifying the function code type (shown in Table 7.2) and number in a 4-digit hexadecimal notation.

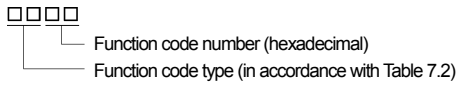

Table 7.2 Function Code Type

Type	Type Code	Function Code	Type	Type Code	Function Code		
S	2	02h	Command/function data	A	9	09h	Motor 2 function
M	3	03h	Monitored data	o	10	0Ah	Optional function
F	4	04h	Fundamental function	J	14	0Eh	Application function
E	5	05h	Terminal function	y	15	0Fh	Link function
C	6	06h	Control function	W	16	10h	Monitor 2
P	7	07h	Motor 1 function	X	17	11h	Alarm 1
H	8	08h	High performance function	Z	18	12h	Alarm 2

Example: For F26: F ⇒ Type Code 04  
 26 ⇒ 1A (hexadecimal) } 041a

**Note** Once you have modified the settings for o40 to o43 and o48 to o51, be sure to restart both the inverter and this option in order to validate the new settings.

**7.3 An Example of Actual I/O Communication Data**

Presented herein is an actual communication data in the format of Extended Speed Control Instance, the factory default format.

(1) Driving pattern example

Given below is an example of the driving pattern for controlling the inverter. Its corresponding I/O data is shown in (2) on the next page.

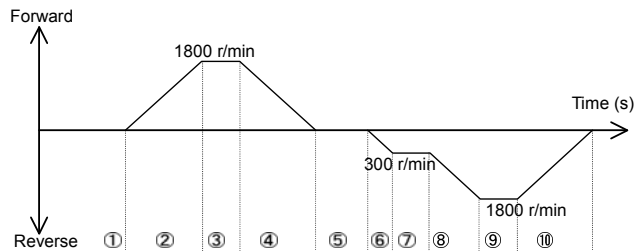

Figure 8 Driving Pattern

(2) Description of I/O Data (The I/O data are in hexadecimal notation.)

- ① Request: Run command is OFF. Speed command = 1800 r/min (= 0708h). The run command and speed command via DeviceNet are enabled.  
**60 00 08 07**  
Response: Stopping. The inverter is ready.  
**70 03 00 00**
- ② Request: Run forward command. Speed command = 1800 r/min (= 0708h). The run command and speed command via DeviceNet are enabled.  
**61 00 08 07**  
Response: The motor is running forward and accelerating. The actual speed is increasing.  
**74 04 \*\* \*\***
- ③ Request: Run forward command. Speed command = 1800 r/min (= 0708h). The run command and speed command via DeviceNet are enabled.  
**61 00 08 07**  
Response: Running forward. The actual speed has reached the Reference  
**F4 04 08 07**
- ④ Request: Run command is OFF. Speed command = 1800 r/min (= 0708h). The run command and speed command via DeviceNet are enabled.  
**60 00 08 07**  
Response: The motor is running forward and decelerating. The actual speed is decreasing.  
**74 05 \*\* \*\***
- ⑤ Request: No run command. Speed command is changed to 300 r/min (= 012Ch). The run command and speed command via DeviceNet are enabled.  
**60 00 2C 01**  
Response: Stopping. The inverter is ready.  
**70 03 00 00**
- ⑥ Request: Run reverse command. Speed command = 300 r/min (= 012Ch). The run command and speed command via DeviceNet are enabled.  
**62 00 2C 01**  
Response: The motor is running backward (in the reverse direction) and accelerating. The actual speed is increasing.  
**78 04 \*\* \*\***
- ⑦ Request: Run reverse command. Speed command = 300 r/min (= 012Ch). The run command and speed command via DeviceNet are enabled.  
**62 00 2C 01**  
Response: Running in the reverse direction. The actual speed has reached Reference  
**F8 04 2C 01**
- ⑧ Request: Run reverse command. Speed command is changed to 1800 r/min (= 0708h). The run command and speed command via DeviceNet are enabled.  
**62 00 08 07**  
Response: The motor is running backward (in the reverse direction) and accelerating. The actual speed is increasing.  
**78 04 \*\* \*\***
- ⑨ Request: Run reverse command. Speed command = 1800 r/min (= 0708h). The run command and speed command via DeviceNet are enabled.  
**62 00 08 07**  
Response: Running in the reverse direction. The actual speed has reached Reference  
**F8 04 08 07**
- ⑩ Request: Run command is OFF. Speed command = 1800 r/min (= 0708h). The run command and speed command via DeviceNet are enabled.  
**60 00 08 07**  
Response: The motor is running backward (in the reverse direction) and decelerating. The actual speed is decreasing.  
**78 05 \*\* \*\***

#### 7.4 I/O Assembly Instances Assigned to Word Variables (For reference)

Some masters assign an I/O assembly instance area to a word variable. Shown below are the formats for each I/O assembly instance assigned to a word variable. For details about the definition of bits in the formats, refer to Section 7.2, "I/O ASSEMBLY INSTANCES: SELECTION AND SETUP."

##### (1) Basic Speed Control Instance

Output (from master to this option): o31=20

word	bit15	14	13	12	11	10	9	8	7	6	5	4	3	2	1	bit0
0	-	-	-	-	-	-	-	-	-	-	-	-	-	Fault Reset	-	Run Forward
1	Speed Reference (r/min)															

Input (from this option to master): o32=70

word	bit15	14	13	12	11	10	9	8	7	6	5	4	3	2	1	bit0
0	-	-	-	-	-	-	-	-	-	-	-	-	-	Running Forward	-	Faulted
1	Speed Actual (r/min)															

##### (2) Extended Speed Control Instance

Output (from master to this option): o31=21

word	bit15	14	13	12	11	10	9	8	7	6	5	4	3	2	1	bit0
0	-	-	-	-	-	-	-	-	-	Net Ref	Net Ctrl	-	-	Fault Reset	Run Reverse	Run Forward
1	Speed Reference (r/min)															

Input (from this option to master): o32=71

word	bit15	14	13	12	11	10	9	8	7	6	5	4	3	2	1	bit0
0	-	-	-	-	-	-	-	-	At Reference	*2	*1	Ready	Running Reverse	Running Forward	-	Faulted
1	Speed Actual (r/min)															

\*1 CtrlFromNet

\*2 RefFromNet

##### (3) Fuji Drive Assembly Instance

Output (from master to this option): o31=100

word	bit15	14	13	12	11	10	9	8	7	6	5	4	3	2	1	bit0
0	RST	XR	XF	-	-	-	-	-	-	X5	X4	X3	X2	X1	RE V	FW D
1	Frequency command p.u.															

Input (from this option to master): o32=101

word	bit15	14	13	12	11	10	9	8	7	6	5	4	3	2	1	bit0
0	BUS Y	ER R	-	RL	AL M	DE C	AC C	IL	VL	TL	NU V	BR K	INT	EXT	RE V	FW D
1	Frequency command p.u.															

(4) User Defined Assembly Instance

Output (from master to this option): o31=102

word	bit15	14	13	12	11	10	9	8	7	6	5	4	3	2	1	bit0
0	User-defined function code 1 (write) (data of function code specified by o40)															
1	User-defined function code 2 (write) (data of function code specified by o41)															
2	User-defined function code 3 (write) (data of function code specified by o42)															
3	User-defined function code 4 (write) (data of function code specified by o43)															

Input (from this option to master): o32=103

word	bit15	14	13	12	11	10	9	8	7	6	5	4	3	2	1	bit0
0	User-defined function code 1 (read) (data of function code specified by o48)															
1	User-defined function code 2 (read) (data of function code specified by o49)															
2	User-defined function code 3 (read) (data of function code specified by o50)															
3	User-defined function code 4 (read) (data of function code specified by o51)															

## Chapter 8 EXPLICIT MESSAGE

### 8.1 Overview

Explicit Message is a communication process that accesses DeviceNet variables at arbitrary (event-driven) timing. Using this option is capable of accessing not only standard DeviceNet variables but also all inverter's function codes. Explicit Message lacks realtime performance, but it allows many variables to be set or referred to. It is, therefore, suited for initial setting.

 Refer to the user's manual of the connected master for Explicit Message.



- Variables usable in Explicit Message are grouped using three codes—Class (major key), Instance (medium key) and Attribute (minor key). These three codes should be used for specifying a variable.
- A group of all variables contained in Class is called "Object."

### 8.2 Objects to be Used in Explicit Message

This section describes objects relating to this option and the inverter. Other objects that are automatically executed by the master device are excluded in this manual.

#### (1) Identity object (Class 01 hex.)

This object refers to the product information of this option. It is a group of read-only variables.

Instance	Attribute	Name	Description	Value (hex.)	R/W	Data size
0	01	Revision	Revision number of Identity object	0001	R	Word
1	01	Vender ID	Manufacturer's ID code	013F (=319): Fuji Electric	R	Word
	02	Device Type	Applied device profile	0002: AC drive	R	Word
	03	Product Code	ID code of this option	2402	R	Word
	04	Revision	Software version (Major and minor versions)	Display of version Example: 01, 0A (=Ver. 1.10)	R	Byte, Byte
	05	Status	Status of this option	Depends on DeviceNet specifications.	R	Word
	06	Serial Number	Serial number of the product	Differs with the product.	R	DWord
	07	Product Name	Model name	OPC-E1-DEV	R	11 bytes

#### (2) Motor Data object (Class 28 hex.)

This object refers to and sets up the motor rated current and voltage. When Motor 2 is selected, this object automatically switches to the one for Motor 2.

Instance	Attribute	Name	Description	Value (hex.)	R/W	Data size
0	01	Revision	Revision number of Motor Data object	0001	R	Word
1	03	Motor Type	Type of motor connected	07: Squirrel-cage, induction motor	R	Byte
	06	Rated Current	Rated current in units of 0.1 A	Depends on the inverter setting.	R/W	Word
	07	Rated Voltage	Rated voltage in units of 1 V (base voltage)	Depends on the inverter setting.	R/W	Word

**(3) Control Supervisor object (Class 29 hex.)**

This object monitors the current run command settings and the running status of the inverter, and configures the running-related settings.

Instance	Attribute	Name	Description	Value (hex.)	R/W	Data size
0	01	Revision	Revision number of Control Supervisor object	0001	R	Word
1	03	Run1	Run forward command	00: OFF 01: ON	R/W	Byte
	04	Run2	Run reverse command	00: OFF 01: ON	R/W	Byte
	05	NetCtrl	Switching run command source	00: Inverter 01: DeviceNet	R/W	Byte
	06	State	Current inverter status	01: Inverter running 02: Inverter not ready to run 03: Inverter ready to run 04: Inverter running 05: During deceleration 06: Stop due to communication broken 07: Tripped	R	Byte
	07	Running1	Running forward	00: Stopped /Running reverse 01: Running forward	R	Byte
	08	Running2	Running reverse	00: Stopped /Running forward 01: Running reverse	R	Byte
	09	Ready	Inverter ready to run/Inverter running (Synchronized with State above)	00: State = Value except below 01: State = 03 to 05	R	Byte
	0A	Faulted	Tripped state	00: Not tripped 01: Tripped	R	Byte
	0B	Warning	Warning. Fixed at 0.	00: No warning	R	Byte
	0C	FaultRst	Reset of tripped (alarm) state	00→01: Request for reset	R/W	Byte
	0F	CtrlFromNet	Current run command source	00: Inverter 01: DeviceNet	R	Byte
10	DNFaultMode	Inverter reaction to DeviceNet communications errors	Refer to Chapter 9.	R/W	Byte	



**(4) AC/DC Drive object (Class 2A hex.)**

This object monitors the current speed command settings and the current speed of the inverter, and configures their related settings. It also monitors the output data issued from the inverter.

Instance	Attribute	Name	Description	Value (hex.)	R/W	Data size
0	01 hex	Revision	Revision number of AC/DC Drive object	0001	R	Word
1	03 hex	AtReference	Speed arrival	00: Stopped/ Accelerating or decelerating 01: Speed arrival	R	Byte
	04 hex	NetRef	Switching speed command source	00: Inverter 01: DeviceNet	R/W	Byte
	06 hex	DriveMode	Run mode. Fixed at 0.	00: Unique to vendor	R	Byte
	07 hex	SpeedActual	Speed monitor (r/min)	Actual speed	R	Word
	08 hex	SpeedRef	Speed command (r/min)	-32768 to 32767 r/min	R/W	Word
	09 hex	CurrentActual	Output current (in units of 0.1 A)	Output current	R	Word
	11 hex	OutputVoltage	Output voltage (V)	Output voltage	R	Word
	12 hex	AccelTime	Acceleration time (ms)	0 to 65535 ms	R/W	Word
	13 hex	DeccelTime	Deceleration time (ms)	0 to 65535 ms	R/W	Word
	14 hex	LowSpdLimit	Lower limit speed (r/min)	0 to 32767 r/min	R/W	Word
	15 hex	HighSpdLimit	Maximum speed (r/min)	0 to 32767 r/min	R/W*1	Word
	16 hex	SpeedScale	Change the speed scale (r/min) all at once, as calculated below.  $\frac{\text{r/min}}{2^{\text{SpeedScale}}}$	-15 to 15 (Factory default: 0)	R/W	Byte
	17 hex	CurrentScale	Change the current scale (0.1 A) all at once, as calculated below.  $\frac{0.1 \text{ A}}{2^{\text{CurrentScale}}}$	-15 to 15 (Factory default: 0)	R/W	Byte
	1B hex	VoltageScale	Change the voltage scale (V) all at once, as calculated below.  $\frac{\text{V}}{2^{\text{VoltageScale}}}$	-15 to 15 (Factory default: 0)	R/W	Byte
1C hex	TimeScale	Change the time scale (ms) all at once, as calculated below.  $\frac{\text{ms}}{2^{\text{TimeScale}}}$	-15 to 15 (Factory default: 0)	R/W	Byte	
1D hex	RefFromNet	Current speed command source	00: Inverter 01: DeviceNet	R	Byte	

\*1 "Read-only" while the inverter is running.

**(5) Inverter Function Code object (Class 64 hex.)**

This object configures or refers to inverter's function codes.



Instance corresponds to function code group and Attribute, to function code number.

Example: To configure F26 data, specify 04 hex for Instance and 1A hex (=26) for Attribute.

Inverter's function codes have individually specified data formats. For details about the data formats, refer to the RS-485 Communication User's Manual (MEH448), Chapter 5 "Function Codes and Data Formats." For details about function code data, refer to the FRENIC-Multi Instruction Manual (INR-SI47-1204-E), Chapter 5, "Function Codes."

Instance	Attribute	Name	Description	Value (hex.)	R/W	Data size
00	01	Revision	Revision number of Inverter Function Code object	0001	R	Word
02 (S codes)	01	S01	Communication function code S01	0 to FFFF	RW	Word
	:	:	:	:	:	:
	:	:	:	:	:	:
	63 hex (99)	S99	Communication function code S99	0 to FFFF	RW	Word
03 (M codes)	01	M01	Communication function code M01	0 to FFFF	R	Word
	:	:	:	:	:	:
	:	:	:	:	:	:
	63 hex (99)	M99	Communication function code M99	0 to FFFF	R	Word
04 (F codes)	01	F01	Inverter function code F01	0 to FFFF	RW	Word
	:	:	:	:	:	:
	:	:	:	:	:	:
	63 hex (99)	F99	Inverter function code F99	0 to FFFF	RW	Word
05 (E codes)	01	E01	Inverter function code E01	0 to FFFF	RW	Word
	:	:	:	:	:	:
	:	:	:	:	:	:
	63 hex (99)	E99	Inverter function code E99	0 to FFFF	RW	Word
06 (C codes)	01	C01	Inverter function code C01	0 to FFFF	RW	Word
	:	:	:	:	:	:
	:	:	:	:	:	:
	63 hex (99)	C99	Inverter function code C99	0 to FFFF	RW	Word
07 (P codes)	01	P01	Inverter function code P01	0 to FFFF	RW	Word
	:	:	:	:	:	:
	:	:	:	:	:	:
	63 hex (99)	P99	Inverter function code P99	0 to FFFF	RW	Word
08 (H codes)	01	H01	Inverter function code H01	0 to FFFF	RW	Word
	:	:	:	:	:	:
	:	:	:	:	:	:
	63 hex (99)	H99	Inverter function code H99	0 to FFFF	RW	Word
09	01	A01	Inverter function code A01	0 to FFFF	RW	Word

(A codes)	:	:	:	:	:	:	
	:	:	:	:	:	:	
	63 (99)	hex	A99	Inverter function code A99	0 to FFFF	RW	Word
0A (10)	01		o01	Option function code o01	0 to FFFF	RW	Word
(o codes)	:	:	:	:	:	:	
	:	:	:	:	:	:	
	63 (99)	hex	o99	Option function code o99	0 to FFFF	RW	Word
0E (14)	01		J01	Inverter function code J01	0 to FFFF	RW	Word
(J codes)	:	:	:	:	:	:	
	:	:	:	:	:	:	
	63 (99)	hex	J99	Inverter function code J99	0 to FFFF	RW	Word

Instance	Attribute	Name	Description	Value (hex.)	R/W	Data size
0F (15) (y codes)	01	y01	Inverter function code y01	0 to FFFF	R/W	Word
	:	:	:	:	:	:
	:	:	:	:	:	:
	63 hex (99)	y99	Inverter function code y99	0 to FFFF	R/W	Word
10 (16) (W codes)	01	W01	Communication function code W01	0 to FFFF	R	Word
	:	:	:	:	:	:
	:	:	:	:	:	:
	63 hex (99)	W99	Communication function code W99	0 to FFFF	R	Word
11 (17) (X codes)	01	X01	Communication function code X01	0 to FFFF	R	Word
	:	:	:	:	:	:
	:	:	:	:	:	:
	63 hex (99)	X99	Communication function code X99	0 to FFFF	R	Word
12 (18) (Z codes)	01	Z01	Communication function code Z01	0 to FFFF	R	Word
	:	:	:	:	:	:
	:	:	:	:	:	:
	63 hex (99)	Z99	Communication function code Z99	0 to FFFF	R	Word

### 8.3 Error Code List for Explicit Message Errors

If an explicit message sent from the master contains any error, this option responds to the master with "94" in the service code and "error code" (see Table 8.1) in the data.

An error code is two bytes long, consisting of a general code and additional code. Some error codes have no additional code and have "FF" instead.

Table 8.1 Error Code List for Explicit Message Errors

Error code		Error name	Description	Error recovery
General code	Additional code			
08	FF	Service not supported	Invalid service code	Correct service code. (Read: 0E hex, Write: 10 hex)
0E	FF	Invalid attribute value	Attempted to change a write-inhibited variable.	Check the specified variable again.
13	FF	Not enough data	Attempted to write Byte data to Word variable.	Match the data size.
14	FF	Attribute not supported	Access to a nonexistent variable.	Check the specified variable again.
15	FF	Too much data	Attempted to write Word data to Byte variable.	Match the data size.
16	FF	Object does not exist	Access to a nonexistent object.	Correct the contents of the Class.
1F	See below.	Vendor specific error	Error unique to vendor	See below.
	02	No function code (in writing)	Attempted to write to a nonexistent function code.	Correct the function code number specified.
	03	Function code not allowed to change	Attempted to write to a read-only function code.	Correct the function code number specified.
	06	Not allowed to change in running	Attempted to write to a function code not allowed to change when the inverter is running.	Write after the inverter is stopped.
	07	Not allowed to change with X terminal being ON	Attempted to write to a function code not allowed to change when X terminal is ON.	Write after the X terminal is turned OFF.
	08	Data entry range error	Attempted to write data out of the range.	Write data within the range.
	0F	Function code data being written	Requested to write to a function code being written.	Request to write after completion of the current writing operation.
	21	No function code (in reading)	Attempted to read from a nonexistent function code.	Correct the function code number specified.
20	FF	Invalid parameter	Attempted to write a value out of the range.	Correct the value within the range.

## Chapter 9 INVERTER REACTION TO DeviceNet COMMUNICATIONS ERRORS

Inverter's function codes o27 and o28 specify the inverter reaction to be taken after an error occurrence. Table 9.1 lists the settings for o27 and o28. The same setting can also be made by the DeviceNet variable DNFaultMode (Class: 0x29, Instance: 0x01, Attribute: 0x10).

Table 9.2 lists the inverter reaction specified by the DNFaultMode. The setting value of o27 and that of DNFaultMode are interlocked with each other. Changing either one automatically changes the other one.

Table 9.1 Inverter Reactions to DeviceNet Communications Errors Specified by Function Codes o27 and o28

o27 data	o28 data	Inverter reaction to DeviceNet communications error	Remarks
0, 4 to 9	—	Immediately coast to a stop and trip with <i>er5</i> .	
1	0.0 s to 60.0 s	After the time specified by o28, coast to a stop and trip with <i>er5</i> .	
2	0.0 s to 60.0 s	If the communications link is restored within the time specified by o28, ignore the communications error. After the timeout, coast to a stop and trip with <i>er5</i> .	
3, 13 to 15	—	Keep the current operation, ignoring the communications error. (No <i>er5</i> trip)	
10	—	Immediately decelerate to a stop. Issue <i>er5</i> after stopping.	The inverter's function code F08 specifies the deceleration time.
11	0.0 s to 60.0 s	After the time specified by o28, decelerate to a stop. Issue <i>er5</i> after stopping.	Same as above.
12	0.0 s to 60.0 s	If the communications link is restored within the time specified by o28, ignore the communications error. After the timeout, decelerate to a stop and trip with <i>er5</i> .	Same as above.
13	—	Immediately run command OFF. (No <i>er5</i> trip)	
14	—	Force to rotate the motor in forward direction. (No <i>er5</i> trip)	Forward rotation is enabled when NetCtrl = 1.
15	—	Force to rotate the motor in reverse direction. (No <i>er5</i> trip)	Reverse rotation is enabled when NetCtrl = 1.

Table 9.2 Inverter Reactions to DeviceNet Communications Errors Specified by DNFaultMode

DNFaultMode	Inverter reaction to DeviceNet communications error	Remarks	o27 data
0	Immediately run command OFF. (No <i>er5</i> trip)		13
1	Ignore the communications error. (No <i>er5</i> trip)		3
2	If the communications link is restored within the time specified by o28, ignore the communications error. After the timeout, decelerate to a stop and trip with <i>er5</i> .	The inverter's function code F08 specifies the deceleration time.	12
3	Force to rotate the motor in forward direction. (No <i>er5</i> trip)	Forward rotation is enabled when NetCtrl = 1.	14
4	Force to rotate the motor in reverse direction. (No <i>er5</i> trip)	Reverse rotation is enabled when NetCtrl = 1.	15
100	Immediately coast to a stop and trip with <i>er5</i> .		0
101	After the time specified by o28, coast to a stop and trip with <i>er5</i> .		1
102	If the communications link is restored within the time specified by o28, ignore the communications error. After the timeout, coast to a stop and trip with <i>er5</i> .		2
110	Immediately decelerate to a stop. Issue <i>er5</i> after stopping.	The inverter's function code F08 specifies the deceleration time.	10
111	After the time specified by o28, decelerate to a stop. Issue <i>er5</i> after stopping.	Same as above.	11
112	Same as for [DNFaultMode = 2]		12

## Chapter 10 ALARM CODE LIST

The information on alarms that have occurred in the inverter can be monitored through DeviceNet.

They are stored in the inverter's function codes M16 to M19 as listed in Table 10.1.

The communication dedicated function codes M16 to M19 store information on the current alarm code, most recent alarm code, 2nd recent alarm code, and 3rd recent alarm code, respectively.

Table 10.1 Alarm Codes

Alarm codes in M16 to M19	Description		Alarm codes in M16 to M19	Description	
0	No alarm	---	22	Braking resistor overheated	<i>dbh</i>
1	Overcurrent (during acceleration)	<i>0c1</i>	23	Motor 1 overload	<i>0l1</i>
2	Overcurrent (during deceleration)	<i>0c2</i>	24	Motor 2 overload	<i>0l2</i>
3	Overcurrent (During running at constant speed)	<i>0c3</i>	25	Inverter overload	<i>0lu</i>
5	Ground fault	<i>ef</i>	31	Memory error	<i>er1</i>
6	Overvoltage (during acceleration)	<i>0u1</i>	32	Keypad communications error	<i>er2</i>
7	Overvoltage (during deceleration)	<i>0u2</i>	33	CPU error	<i>er3</i>
8	Overvoltage (during running at constant speed (stopped))	<i>0u3</i>	34	Interface option communications error	<i>er4</i>
10	Undervoltage	<i>lu</i>	35	DeviceNet communications error	<i>er5</i>
11	Input phase loss	<i>lln</i>	36	Operation protection	<i>er6</i>
14	Fuse blown	<i>fus</i>	37	Tuning error	<i>er7</i>
16	Charger circuit fault	<i>pbf</i>	38	RS-485 communications error	<i>er8</i>
17	Heat sink overheat	<i>0h1</i>	46	Output phase loss	<i>0pl</i>
18	Alarm issued by an external device	<i>0h2</i>	51	Data saving error during undervoltage	<i>erf</i>
19	Inverter overheat	<i>0h3</i>	53	RS-485 communications error (option card)	<i>erp</i>
20	Motor protection (PTC thermistor)	<i>0h4</i>	54	LSI error (Power printed circuit board)	<i>erh</i>



## Chapter 11 TROUBLESHOOTING

If any problem or error occurs during DeviceNet communication, follow the troubleshooting procedures given below.

No	Phenomenon/Symptom	Probable Causes
1	None of the LEDs on the option would light.	<ul style="list-style-type: none"> <li>No 24 VDC power supply is connected to this option.</li> <li>The option is faulty.</li> </ul>
2	<i>er4</i> alarm cannot be reset (The MS LED lights in red).	<ul style="list-style-type: none"> <li>The option is not properly mounted.</li> <li>The option connection cable is not connected.</li> <li>The option is faulty.</li> </ul>
3	The NS LED lights in red. ( <i>er5</i> alarm cannot be reset.)	<ul style="list-style-type: none"> <li>The same node address is double assigned in DeviceNet.</li> <li>There is a mismatch in baud (data) rate.</li> <li>The network power (24 V) is not properly supplied.</li> <li>Cabling for DeviceNet communications is not properly done.</li> <li>The inverter and the option have not been powered OFF and then ON after modifying the DIP switch settings.</li> </ul>
4	The NS LED blinks in red. ( <i>er5</i> alarm has occurred.)	<ul style="list-style-type: none"> <li>The cable was broken during communication.</li> <li>The I/O scan interval is too short.</li> </ul>
5	The NS LED would not light.	<ul style="list-style-type: none"> <li>The node address for the option is improper.</li> <li>The cable for DeviceNet communications was broken.</li> </ul>
6	The NS LED keeps blinking in green and does not come to stay on in green.	<ul style="list-style-type: none"> <li>The master does not request a connection.</li> <li>The I/O scan interval has been set to be too short at the start of communication.</li> <li>The I/O area is invalidly mapped.</li> <li>There is no I/O connection.</li> </ul>
7	Even though the NS LED lights in green, the settings for run command or speed command cannot be validated.	<ul style="list-style-type: none"> <li>Neither NetCtrl nor NetRef is set to "1."</li> <li>On the inverter, the higher-priority run command or speed command is enabled.</li> <li>There is a mistake in the selection of I/O Assembly Instances.</li> <li>The inverter and the option have not been powered OFF and then ON after modifying the o31 data.</li> </ul>
8	Although the speed command has been validated, the actual speed is different from it.	<ul style="list-style-type: none"> <li>Refer to the FRENIC-Multi Instruction Manual (INR-SI47-1204-E), Section 6.2.1 "Motor is running abnormally."</li> </ul>

## Chapter 12 SPECIFICATIONS

### 12.1 General Specifications

For the items not covered in this section, the specifications of the inverter apply.

Item	Specifications
Power input voltage	21.6 to 27.0 V
Input power	35 mA at maximum (24 VDC) (not included network input power)
Operating ambient temperature range	-10 to +50°C (14 to +122°F)
Operating ambient humidity range	5 to 95% RH (There shall be no condensation.)
External dimensions	79.6 x 127 x 47.5 mm(3.13 x 5 x 1.87 in)

### 12.2 DeviceNet Specifications

For the items not covered in this section, the DeviceNet Specifications Release 2.0 apply.

Item	Specifications			
Network input voltage	11 to 28 V			
Network power consumption	75 mA at maximum (24 VDC)			
No. of nodes connected	64 at maximum (including the master)			
MAC ID	0 to 63			
Insulation	500 VDC (photocoupler insulation)			
Transmission rate	500 kbps/250 kbps/125 kbps			
Maximum cable length (Trunk line: thick cable Drop line: thin cable)	Transmission rate	500 kbps	250 kbps	125 kbps
	Trunk line length	100 m (328 ft)	250 m (820 ft)	500 m (1640 ft)
	Drop line length	6 m (19.7 ft)	6 m (19.7 ft)	6 m (19.7 ft)
	Total length of drop lines	39 m (128 ft)	78 m (256 ft)	156 m (512 ft)
Messages supported	1. I/O Message (Poll, Change of State) 2. Explicit Message			
Vendor ID	319 (Fuji Electric Co., Ltd.)			
Device type	AC drive (code: 2)			
Product code	9218			
Model name	OPC-E1-DEV			
Applicable device profile	AC Drive			
No. of input/output bytes	Selectable between 4 and 8 bytes for input and output (independently)			
Applicable DeviceNet Specifications	DeviceNet Specifications Release 2.0 Errata 5 (Certified by ODVA Japan for Conformance Test Version A-18)			
Node type	Group 2 only server			

## **Devicenet Interface Option "OPC-E1-DEV"**

---

### **Instruction Manual**

First Edition, September 2006

Fuji Electric FA Components & Systems Co., Ltd.

---

The purpose of this manual is to provide accurate information in the handling, setting up and operating of DeviceNet Interface Option "OPC-E1-DEV" for the FRENIC-Multi series of inverters. Please feel free to send your comments regarding any errors or omissions you may have found, or any suggestions you may have for generally improving the manual.

In no event will Fuji Electric FA Components & Systems Co., Ltd. be liable for any direct or indirect damages resulting from the application of the information in this manual.

MEMO

---

**Fuji Electric Systems Co., Ltd.**  
**Fuji Electric Corp. of America**

47520 Westinghouse Drive Fremont, CA 94539, U.S.A.  
Tel.+1-510-440-1060 Fax.+1-510-440-1063  
Toll-free support 1-888-900-FUJI(3854)  
**INR-SI47-1157-EU Rev 052010**

<http://www.fujielectric.com/fecoa/>

Information subject to change without notice.

---