



Instruction Manual

**NDIR TYPE
INFRARED GAS
ANALYZER**

TYPE: ZKJ-4

PREFACE

Thank you very much for purchasing Fuji's Infrared Gas Analyzer.

- Be sure to read this instruction manual carefully before performing installation, wiring, operation, and maintenance of the analyzer. Improper handling may result in accidents or injury.
- The specifications of this analyzer are subject to change without prior notice for further product improvement.
- Modification of this analyzer is strictly prohibited unless a written approval is obtained from the manufacturer. Fuji will not bear any responsibility for a trouble caused by such a modification.
- The person who actually operates the analyzer should keep this instruction manual.
- After reading through the manual, be sure to keep it near at hand for future reference.
- This instruction manual should be delivered to the end user without fail.

Manufacturer : Fuji Electric Co., Ltd.
Type : Described in the nameplate on main frame
Date of manufacture : Described in the nameplate on main frame
Country of manufacture : Japan

Delivered Items

Name	Quantity	Remarks
Analyzer main frame	1 unit	
Input/Output terminal module	1 set	
Connection cable	1 pc	
Power cable	1 pc	
Fuse	2 pcs	250V AC/3.15A
Cell window mounting tool	1 pc	With mounting block cell
Slide rail	2 pcs	When specified
Relay board for auto calibration	1 pc	When specified
Relay board connection cable	1 pc	When specified
Instruction manual	1 copy	

Request

- No part or the whole of this manual may be reproduced without written permission of Fuji.
- Description in this manual is subject to change without prior notice for further improvement.



© Fuji Electric Co., Ltd. 2011



Issued in August, 2011

CAUTION ON SAFETY

To operate the analyzer properly, be sure to read “Caution on Safety” carefully.



- The descriptions listed here provide important information on safety. Be sure to observe them at all times. Those safety precautions are classified into 3 levels, “DANGER,” “CAUTION” and “PROHIBITION.”

 DANGER	Improper handling may cause dangerous situations that may result in death or serious injury.
 CAUTION	Improper handling may cause dangerous situations that may result in medium-level troubles, minor injury, or property damage.
 PROHIBITION	Items which must not be done are noted.



Caution on installation and transport of gas analyzer	
 DANGER	<ul style="list-style-type: none"> • The unit is not of explosion-proof specifications. Do not use it in an atmosphere of explosive gases. Otherwise serious accidents such as explosion or fire may result.
 CAUTION	<ul style="list-style-type: none"> • Install the analyzer, observing the rules provided in this manual, in a place that endures the weight of the analyzer. Installation in an inadequate place may cause turnover or fall, resulting in injury. • Be sure to wear protective gloves when lifting the analyzer. Lifting it with bare hands may result in injury. • Be sure to fix the casing before transporting the analyzer. Transportation in unstable state may result in injury. • The gas analyzer is heavy. Two or more persons should carry it, while exercising due care. Otherwise unexpected harm to your body or injury may result. • Take care not to let cable chips and other foreign objects enter the unit during installation work. Otherwise fire, failure, or malfunction may result.

Caution on piping	
 DANGER	<p>Be sure to observe the following precautions while installing piping. Improper piping may result in gas leakage. If the leaking gas contains a toxic component, serious accidents may result. If it contains combustible gases, explosion or fire may result.</p> <ul style="list-style-type: none"> • Connect pipes correctly referring to the instruction manual. • Discharge the exhaust gas outdoors to prevent it from remaining within the sampling device or indoors. • Relieve the exhaust gas from the analyzer to the atmospheric pressure to prevent buildup of undesirable pressure to the analyzer. Otherwise piping within the analyzer may be disconnected, resulting in gas leakage. • Use pipes and pressure reducing valves to which no oil/grease is attached for piping. Otherwise, fire may result.

Caution on wiring	
 CAUTION	<ul style="list-style-type: none"> • Be sure to turn off the power before installing wiring. Otherwise electric shock may result. • Be sure to perform class D grounding work. Otherwise, electric shock or failure may result. • Select a proper wiring material that satisfies the ratings of the instrument. Otherwise, electric shock or fire may result. • Be sure to connect a power supply of correct rating. Otherwise, fire may result.

Caution on use	
 DANGER	<ul style="list-style-type: none"> • Be sure to read the instruction manual for reference gases before handling reference gases such as calibration gas to use them properly.
 CAUTION	<ul style="list-style-type: none"> • Leaving the analyzer unused for a long time or restarting it after long-term suspension requires procedures different from normal operation or suspension procedures. Be sure to follow the instructions in each instruction manual. Otherwise, intended performance may not be achieved, or accidents or injury may result. • Do not operate the analyzer for a long time with its door left open. Otherwise, dust, foreign matter, etc. may stick on internal walls, thereby causing faults.

Caution on use	
 PROHIBITION	<ul style="list-style-type: none"> • Do not touch the input/output terminals with metal or finger. Otherwise, electric shock or injury may result. • Do not smoke or use flames near the analyzer. Otherwise, fire may result. • Do not allow water to enter the analyzer. Otherwise, electric shock or internal fire may result.

Caution on maintenance and check	
 DANGER	<ul style="list-style-type: none"> • Before performing work with the cover of the analyzer kept open for maintenance and check, be sure to purge completely not only within the analyzer but also measuring gas lines with nitrogen or air. Otherwise, poisoning, fire, or explosion may result due to gas leakage.
 CAUTION	<p>Be sure to observe the following to perform work safely, avoiding electric shock or injury.</p> <ul style="list-style-type: none"> • Remove the watch and other metallic objects before work. • Do not touch the instrument wet-handed. • If the fuse is blown, eliminate the cause and replace it with the one of the same capacity and type. Otherwise, electric shock or accidents may result. • Do not use replacement parts other than those specified by the manufacturer. Otherwise, intended performance may not be achieved, or accidents or failures may result. • Dispose replacement parts such as maintenance parts as incombustibles according to the local waste disposal regulations.

Others	
 CAUTION	<ul style="list-style-type: none"> • If the cause of a fault cannot be identified by referring to the instruction manual, be sure to contact your dealer or Fuji's technician in charge of adjustment. Disassembling the instrument carelessly may result in electric shock or injury.

CONTENTS

PREFACE	i
CAUTION ON SAFETY	ii
CONTENTS	v
1. OVERVIEW	1-1
2. NAME AND DESCRIPTION OF EACH UNIT	2-1
2.1 Name and description of main unit	2-1
2.2 Input/Output terminal module	2-2
3. INSTALLATION	3-1
3.1 Installation conditions	3-1
3.2 Installation	3-2
3.2.1 Installation of analyzer main frame	3-2
3.2.2 Mounting input/output terminal module	3-3
3.3 Piping	3-4
3.4 Sampling	3-7
3.4.1 Conditions of sampling gas	3-7
3.4.2 Sampling gas flow	3-7
3.4.3 Preparation of standard gas	3-7
3.4.4 Purging of instrument inside	3-7
3.4.5 Pressure at sampling gas outlet	3-8
3.4.6 Example configuration of gas sampling system	3-8
3.5 Wiring	3-9
3.5.1 Power inlet	3-9
3.5.2 Input/output terminal module	3-9
4. OPERATION	4-1
4.1 Preparation for operation	4-1
4.2 Warm-up operation and regular operation	4-1
5. DESCRIPTION OF DISPLAY AND OPERATION PANELS	5-1
5.1 Name and description of operation panel	5-1
5.2 Overview of display and operation panels	5-2
5.3 Outline of display screen	5-3
5.4 Basic operation	5-6
6. SETTING AND CALIBRATION	6-1
6.1 Switch of range	6-1
6.1.1 Setting of range switch mode	6-1
6.1.2 Manual range switch	6-2

6.2	Calibration Setting	6-3
6.2.1	Setting of calibration concentration	6-3
6.2.2	Setting of manual zero calibration	6-5
6.2.3	Setting of calibration range	6-7
6.2.4	Setting of auto calibration component / range	6-9
6.3	Alarm setting	6-11
6.3.1	Setting of alarm values	6-11
6.3.2	Hysteresis setting	6-13
6.4	Setting of auto calibration	6-14
6.4.1	Auto calibration	6-14
6.4.2	Forced run / stop of auto calibration	6-17
6.5	Setting of auto zero calibration	6-20
6.5.1	Auto zero calibration	6-20
6.5.2	Forced run / stop of auto zero calibration	6-22
6.6	Peak alarm setting	6-25
6.7	Parameter setting	6-27
6.8	Maintenance mode	6-34
6.9	Calibration	6-40
6.9.1	Zero calibration	6-40
6.9.2	Span calibration	6-41
7.	MAINTENANCE	7-1
7.1	Daily check	7-1
7.2	Daily check and maintenance procedures	7-1
7.3	Maintenance of analyzer unit	7-2
7.3.1	Cleaning method for sample cell (pipe cell)	7-2
7.3.2	Cleaning method for sample cell (block cell)	7-4
7.3.3	Optical zero adjustment method (optical balance adjustment)	7-6
7.3.4	Moisture interference compensation adjustment method	7-7
8.	ERROR MESSAGE	8-1
9.	SPECIFICATIONS	9-1
9.1	General specifications	9-1
9.2	Code symbols	9-5
9.3	Outline diagram	9-7

1. OVERVIEW

This infrared gas analyzer (type: ZKJ) measures the concentration of NO, SO₂, CO₂, CO and CH₄ contained in sampling gas on the principle that different atomic molecules have an absorption spectrum in the wave band of infrared rays, and the intensity of absorption is determined by the Lambert-Beer law.

Since this instrument incorporates a compact paramagnetic O₂ sensor, it allows measuring up to 5 components simultaneously by using the built-in O₂ sensor (up to 4 components if O₂ sensor is excluded).

Furthermore, use of a microprocessor or large sized liquid crystal display realizes improvement of operability, accuracy and multi-functions.

This instrument is optimum for measuring combustible gas exhausted from boilers or incinerators, and it is effective for steel gas analysis (blast furnace, steel converter, thermal treatment furnace, sintering (Pellet equipment), coke furnace), storage and maturity of vegetable and fruit, biochemistry (microbe), [fermentation], air pollution [incinerator, exhaust gas desulfurization, denitration], automotive emission (excluding tester), protection against disasters [detection of explosive gas and toxic gas, combustion gas analysis of new building material], growth of plants, chemical analysis [petroleum refinery plant, petroleum chemistry plant, gas generation plant], environment [land concentration, tunnel concentration, parking lot, building management] and various physical and chemical experiments.

2. NAME AND DESCRIPTION OF EACH UNIT

2.1 Name and description of main unit

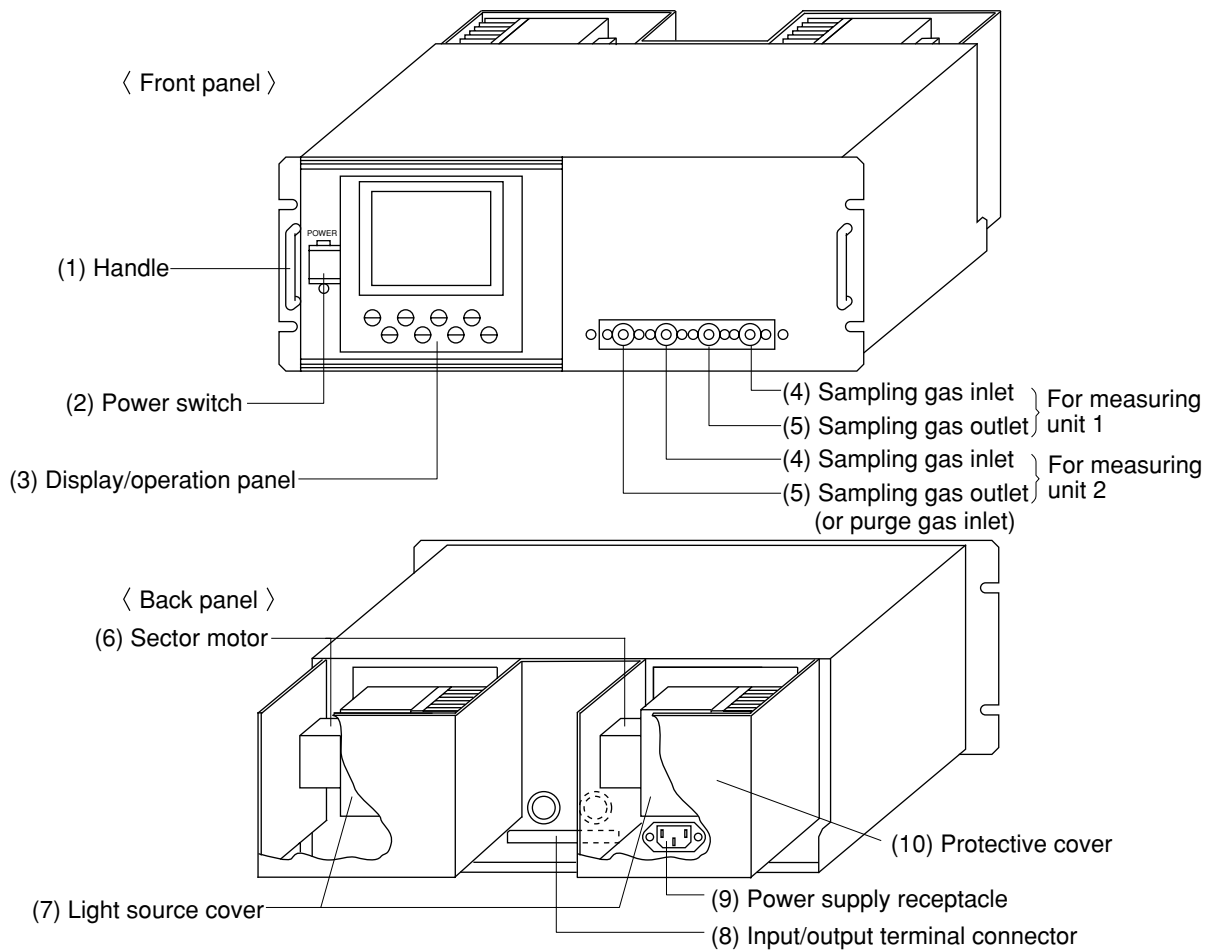

Fig. 2-1

Name	Description	Name	Description
(1) Handle	Used for withdrawing the main unit from the panel.	(6) Sector motor	For driving the rotation of sector
(2) Power switch	Used for ON/OFF the analyzer.	(7) Light source cover	Infrared light source is arranged in the cover.
(3) Display/operation panel	Liquid crystal display and keys for setting various functions	(8) Input/output terminal connector	For connecting to the external input/output terminal module
(4) Sampling gas inlet	For connecting to the measuring gas tube	(9) Power inlet	For connecting the power cable
(5) Sampling gas outlet	Connect to the exhaust line. (A pair of sampling gas inlet/outlet is provided for each measuring unit. When ordered with purge, the piping to measuring unit 2 is built inside. In this case, the sample gas outlet for measuring unit 2 is used for purge gas inlet.)	(10) Protective cover	Protective cover for the light source and the motor. May be removed during operation.

2.2 Input/Output terminal module

This analyzer provides input/output of various signals from the supplied input/output terminal module by connecting the instrument to this module.

〈 Input/Output terminal module 〉

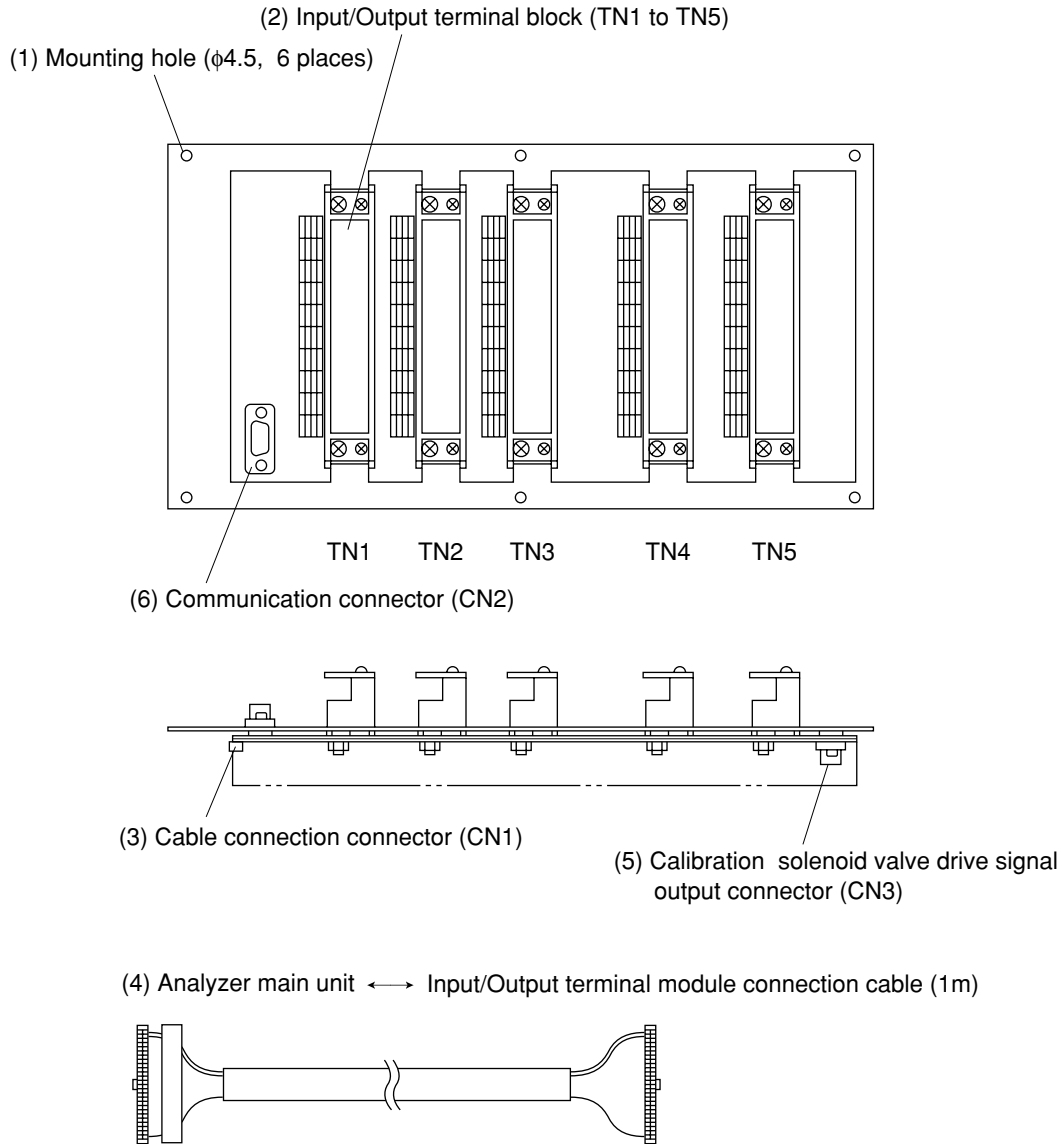

Fig. 2-2

Name	Description	Name	Description
(1) Mounting hole	Used for mounting input/output terminal module. $\phi 4.5$, 6 places	(4) Input/output terminal module connection cable	Used for connecting the analyzer main unit to the input/output terminal module.
(2) Input/output terminal block (TN 1 to TN 5)	Input/output terminal for signals of analog output, range identification contact, alarm contact output, etc.	(5) Calibration solenoid valve drive signal output connector	Cable connector for connecting the analyzer to the relay board for automatic calibration.
(3) Cable connection connector	Used for connecting the analyzer main unit and the input/output terminal module (4).	(6) Communication connector	Connect communication cable. *Please refer to another manual (INZ-TN513327-E) about communication function.

3. INSTALLATION

DANGER

This unit is not explosion-proof type. Do not use it in a place with explosive gases to prevent explosion, fire or other serious accidents.

CAUTION

- Entrust the installation, movement or re-installation to a specialist or the supplier. A poor installation may cause accidental tipover, shock hazard, fire, injury, etc.
- The gas analyzer is heavy. It should be installed with utmost care. Otherwise, it may tip over or drop, for example, causing accident or injury.
- For lifting the gas analyzer, be sure to wear protective gloves. Bare hands may invite an injury.
- This unit should be installed in a place which conforms to the conditions noted in the instruction manual. Otherwise, it may cause electric shocks, fire or malfunction of the unit.
- During installation work, care should be taken to keep the unit free from entry of cable chips or other foreign objects. Otherwise, it may cause fire, trouble or malfunction of the unit.

3.1 Installation conditions

To install the analyzer for optimum performance, select a location that meets the following conditions;

- (1) This instrument is system built in type. This instrument should be used while embedded in a panel, locker, or enclosure of steel sheet.
- (2) Use this instrument indoors.
- (3) A vibration-free place
- (4) A place which is clean around the analyzer.
- (5) Power supply
 - Rated voltage : 100V to 240V AC
 - Operating voltage : 85V to 264V AC
 - Rated frequency : 50/60 Hz
 - Power consumption : 250 VA max.
 - Inlet : Conformity to EN60320 class I type 3-pin inlet
- (6) Operation conditions
 - Ambient temperature : -5° to 45°C
 - Ambient humidity : 90 % RH or less, no condensation

3.2 Installation

3.2.1 Installation of analyzer main frame

Installation methods for the analyzer main unit are divided into 2 types;

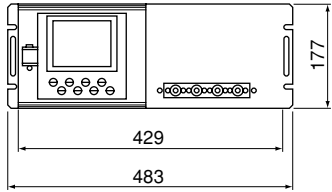
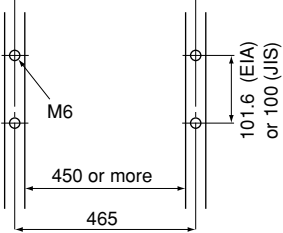
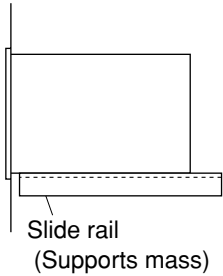
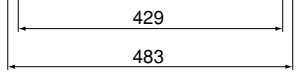
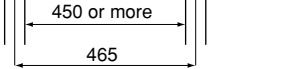
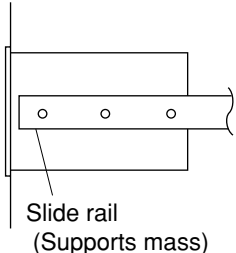
Type	External dimensions	Mounting dimensions	Mounting method
19 inch rack mounting guide rail method			
19 inch rack mounting slide rail method			

Note 1 Check and maintenance of the analyzer main unit may be carried out with the top cover detached. The guide rail method may be used if a space accessible for maintenance is provided at the top of the main unit. If maintenance space is not provided specially, it is recommended to use the slide rail method.

Recommended slide rail: Product No.: 305A-24 manufactured by Accuride International Co.

Note 2 For 19 inch rack mounting, the weight of the analyzer is supported with the bottom of the case (with the side of the case in case of slide rail method). For mounting dimensions of the slide rail, see "Item 9.3 External diagram".

Don't install the analyzer at a place which is exposed to direct sunlight.

The analyzer should be installed at a place where ambient temperature is within -5 to 45°C , and temperature fluctuation during use is minimum.

3.2.2 Mounting input/output terminal module

Mount the input/output terminal module on the panel; observing the following method.

(Note) To avoid the effect of noise generated from external units, mount the I/O terminal module mounting plate on the panel for continuity at the mounting surface and connect the panel to the same ground as the analyzer main unit.

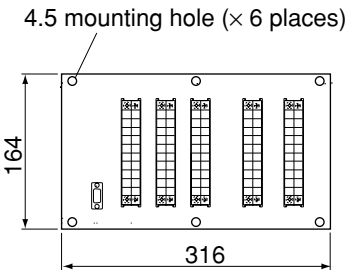
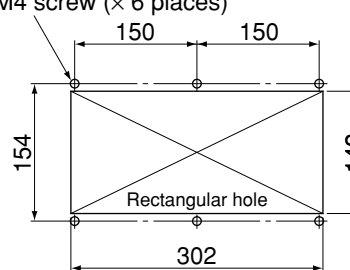
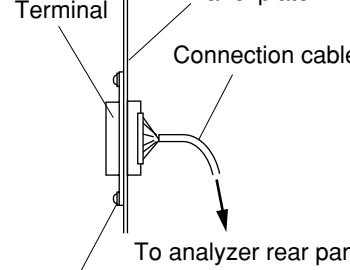
External dimensions	Mounting dimensions	Mounting method
 <p>4.5 mounting hole (× 6 places)</p> <p>164</p> <p>316</p>	 <p>M4 screw (× 6 places)</p> <p>150 150</p> <p>154</p> <p>142</p> <p>302</p> <p>Rectangular hole</p>	 <p>Terminal</p> <p>Panel plate</p> <p>Connection cable</p> <p>To analyzer rear panel</p> <p>Screwed to panel</p>

Note) How to ground analyzer main unit and I/O terminal module

To avoid the effect of noises, etc. from external units, it is recommended to ground them by the procedure described below.

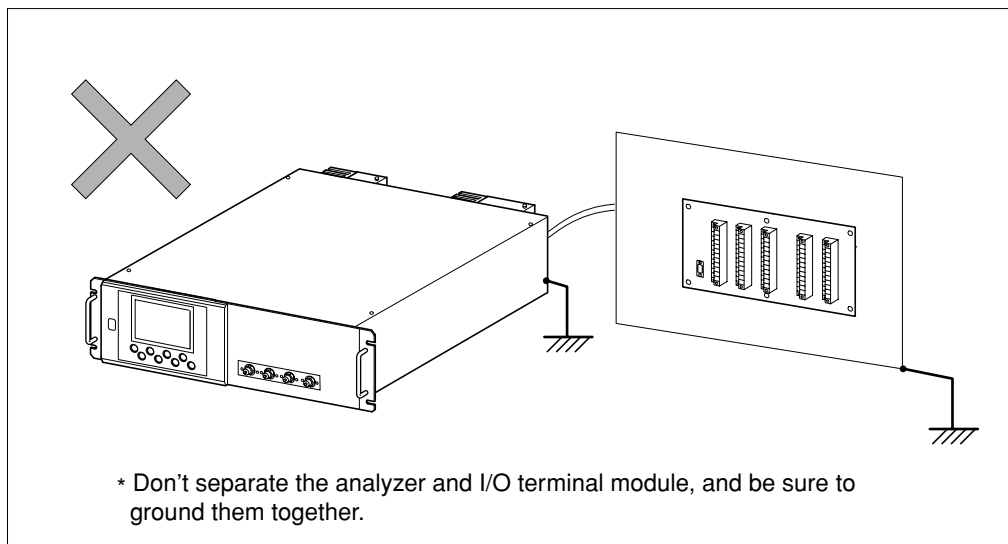
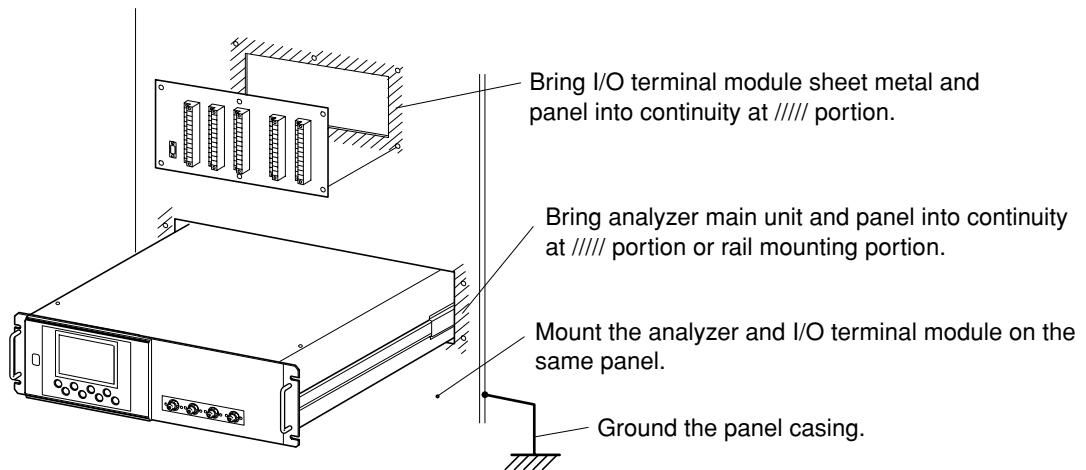

3.3 Piping

Piping should be connected to the gas inlets and outlets of the front panel of the analyzer.

- Use a corrosion resistant tube of Teflon, stainless or polyethylene to connect the instrument to a sampling system. Even if there is a danger of corrosion, refrain from using a tube of rubber or soft vinyl. The instrument provides inaccurate indication due to gas absorption by piping materials.
- Pipe connection port is Rc1/4 female thread (or NPT1/4). Piping should be cut as short as possible for a quick response. About 4 mm inner diameter is recommended.
- Entry of dust into the instrument may result in defective operation. Use a clean piping or coupling.

Connect the gas tube by the following method.

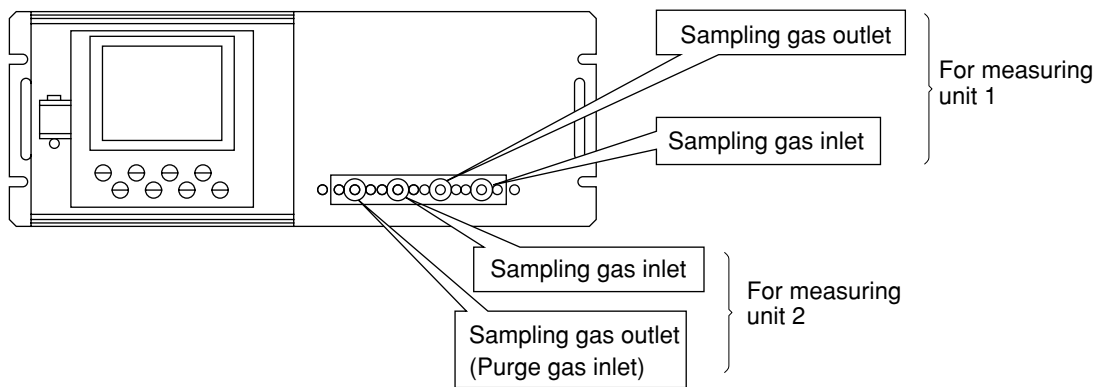

Sampling gas inlet: Attach the gas tube to introduce gas to be measured such as one that has completed dehumidification process and standard gases for zero and span calibration to this inlet.

Gas flow to be introduced should be constant within the range of 0.5 L/min \pm 0.2 L/min.

Sampling gas outlet: Exhaust measured gas through the outlet. Attach the tube to exhaust measured gas outdoors or to the atmosphere.

Purge gas inlet: It is used for purging the inside of the total gas analyzer. When the analyzer must be purged, refer to Item 3.3.4 Purging of instrument inside. Use dry gas N₂ or instrumentation air for purge gas. (flow rate of 1L/min or more).

Internal piping diagram

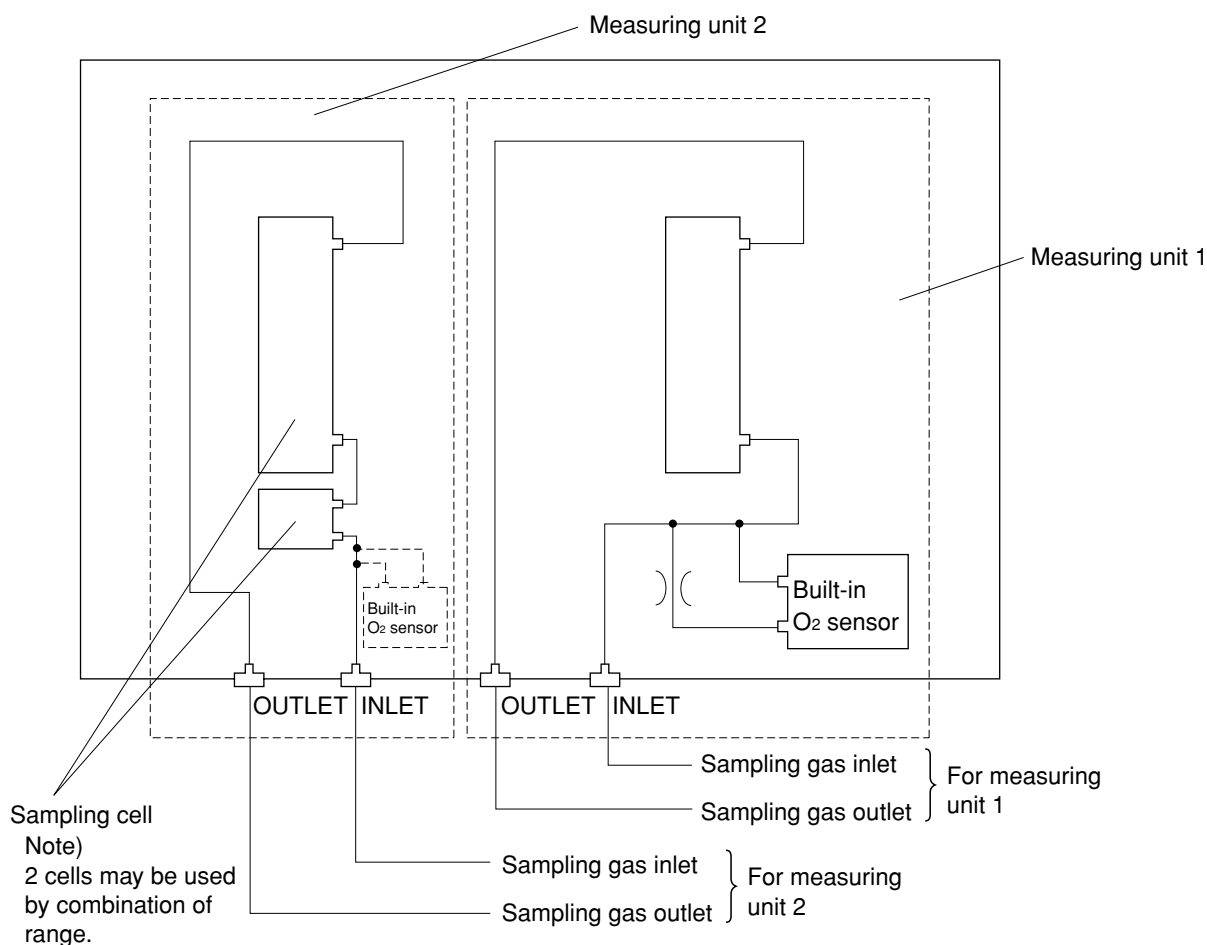

Note) When the purge gas inlet is provided, the piping to measuring unit 2 is built inside.

Correspondence of measured components and measuring units

Measured components	Measuring unit 1	Measuring unit 2
1-component analyzer for NO, SO ₂ , CO ₂ , CO, CH ₄ or N ₂ O	Each measured component	None
2-component analyzer for NO/SO ₂ , CO ₂ /CO, N ₂ O/CO ₂	NO/SO ₂ , CO ₂ /CO, N ₂ O/CO ₂	None
2-component analyzer for NO/CO	NO	CO
3-component analyzer for NO/SO ₂ /CO, N ₂ O/CO ₂ /CO	NO/SO ₂ , N ₂ O/CO ₂	CO
3-component analyzer for NO/N ₂ O/CO ₂ , SO ₂ /N ₂ O/CO ₂ , CH ₄ /N ₂ O/CO ₂	NO, SO ₂ , CH ₄	N ₂ O/CO ₂
3-component analyzer for NO/SO ₂ /CO	NO/SO ₂	CO
4-component analyzer for NO/SO ₂ /CO ₂ /CO, NO/SO ₂ /N ₂ O/CO ₂	NO/SO ₂	CO ₂ /CO, N ₂ O/CO ₂

Note) When there are two measuring units, the built-in O₂ sensor must be connected to the measuring unit 2.

Example of connecting each measuring unit

- One pair of gas inlet/outlet

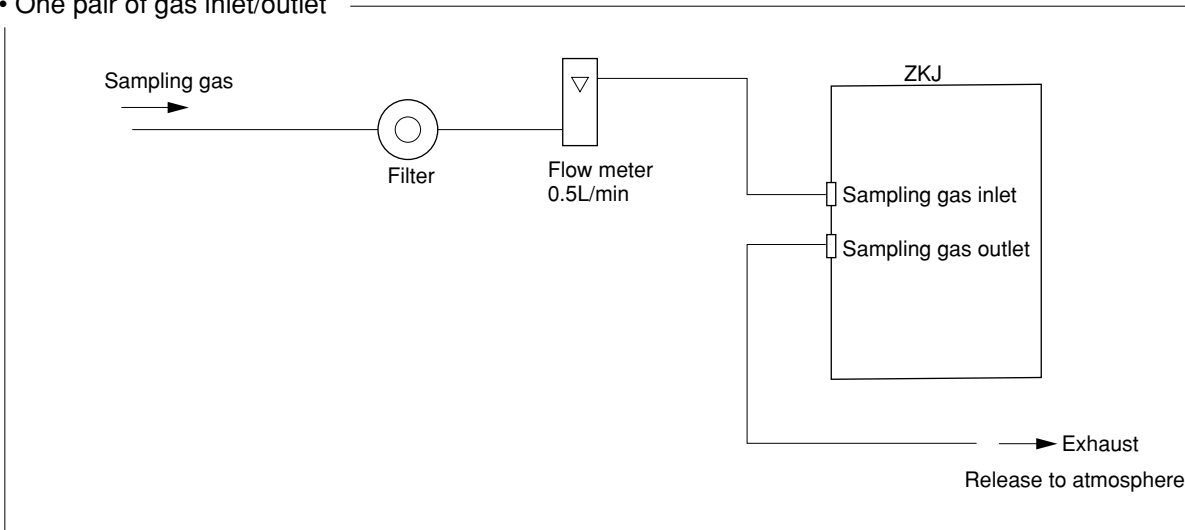

- Two pair of gas inlet/outlet - (1)

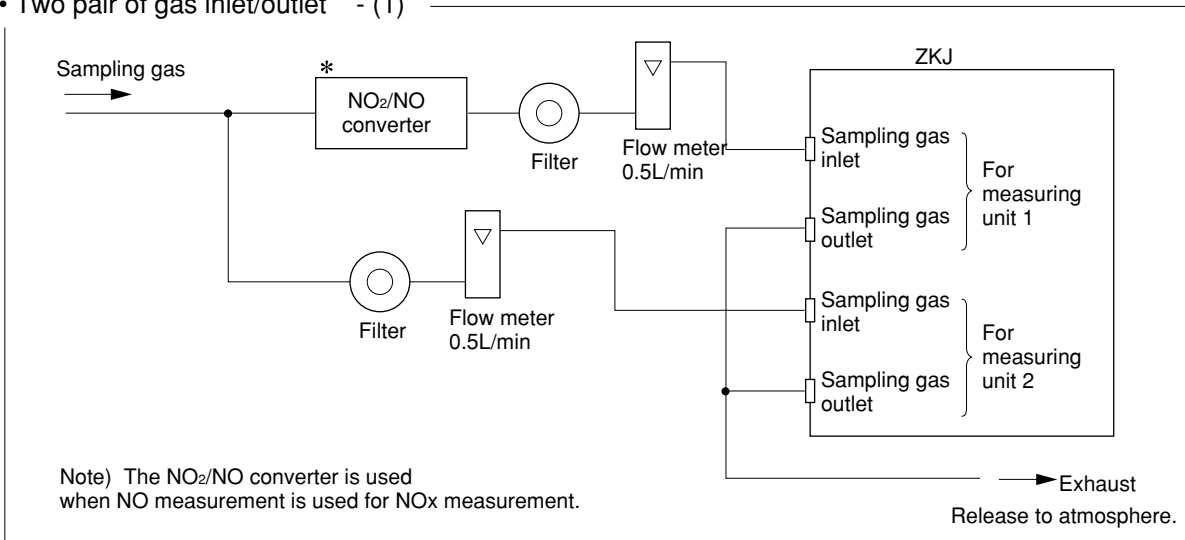

- Two pair of gas inlet/outlet - (2)

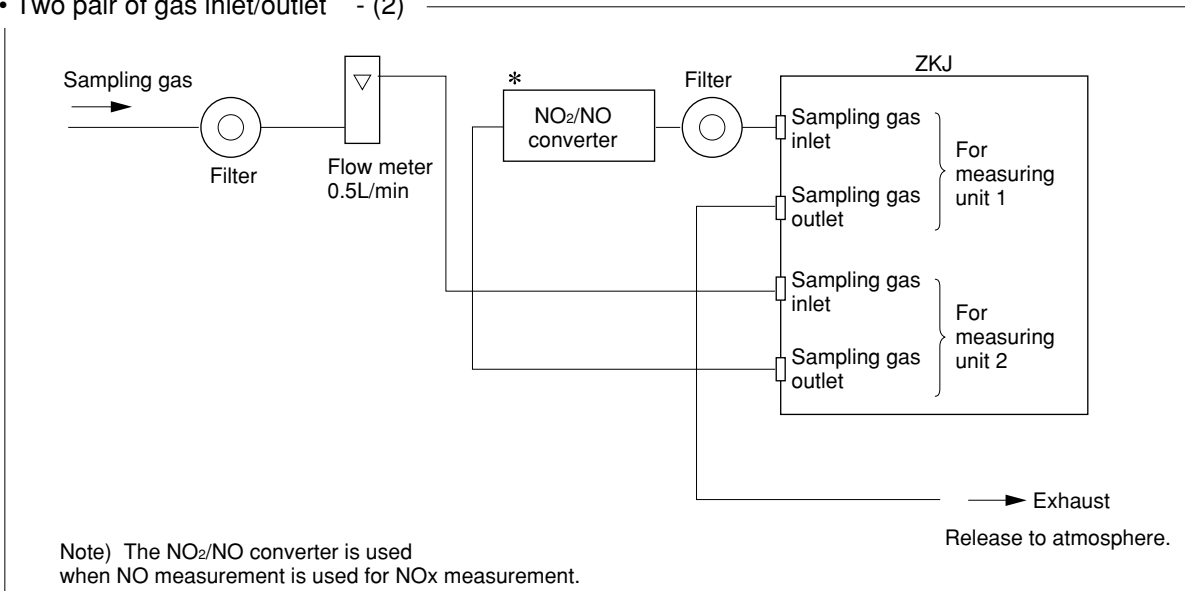

3.4 Sampling

3.4.1 Conditions of sampling gas

- (1) Dust contained in the sampling gas should be completely removed with a filter. For the final stage filter, use a filter that allows removing dust particles of 0.3 μ m.
- (2) Dew point of sampling gas must be lower than the ambient temperature to avoid occurrence of drain in the gas analyzer. If vapor is contained in the sampling gas, dew point should be lowered to 0°C by using a dehumidifier.
- (3) If SO₃ mist is contained in the sampling gas, use a mist filter or cooler to remove SO₃ mist. Other mists should be removed by using a mist filter or cooler.
- (4) Corrosive gases such as Cl₂, F₂ and HCl, if they are contained in the sampling gas in considerable amounts, will shorten the life of instruments.
- (5) Temperature of sampling gas should be within 0 to 50°C. Provide a means that prevents entry of hot gas directly into the instrument.

3.4.2 Sampling gas flow

Flow of sampling gas should be 0.5L/min \pm 0.2L/min.

Avoid flow fluctuation during measurement.

Observe the flow reading by a flowmeter provided as shown in the example of the sampling system configuration (Item 3.4.6).

3.4.3 Preparation of standard gas

Routine calibration is required by standard gas for keeping this instrument under normal operation condition (once a week). Prepare a standard gas cylinder for zero calibration and span calibration.

	Analyzer without O ₂ measurement	Analyzer with built-in O ₂ sensor	Analyzer with external zirconia O ₂ sensor
Zero gas	N ₂ gas	N ₂ gas	Dry air
Span gas other than for O ₂ measurement	Gas with concentration of 90% or more of full scale	Gas with concentration of 90% or more of full scale	Gas with concentration of 90% or more of full scale
Span gas for O ₂ measurement	_____	Gas with concentration of 90% or more of full scale or atmospheric air (21%)	1 to 2% O ₂

3.4.4 Purging of instrument inside

The inside of instrument need not be purged generally except for the following cases.

- (1) A combustible gas component is contained in sample gas.
- (2) Corrosive gas is contained in the atmospheric air at the installation site.
- (3) The same gas as the sample gas component is contained in the atmospheric air at the installation site.

In such cases as above, the inside of analyzer should be purged with the air for instrumentation or N₂.

Purging flow rate should be about 1L/min.

If dust or mist is contained in purging gas, it should be eliminated completely in advance.

3.4.5 Pressure at sampling gas outlet

Pressure at the sampling gas outlet should be adjusted to atmospheric pressure.

3.4.6 Example configuration of gas sampling system

The following illustrates a typical system configuration for five component gas measurement for monitoring combustion exhaust gas from boiler, refuse incinerator, etc.

Contact Fuji Electric for system configuration matching the particular use or further information.

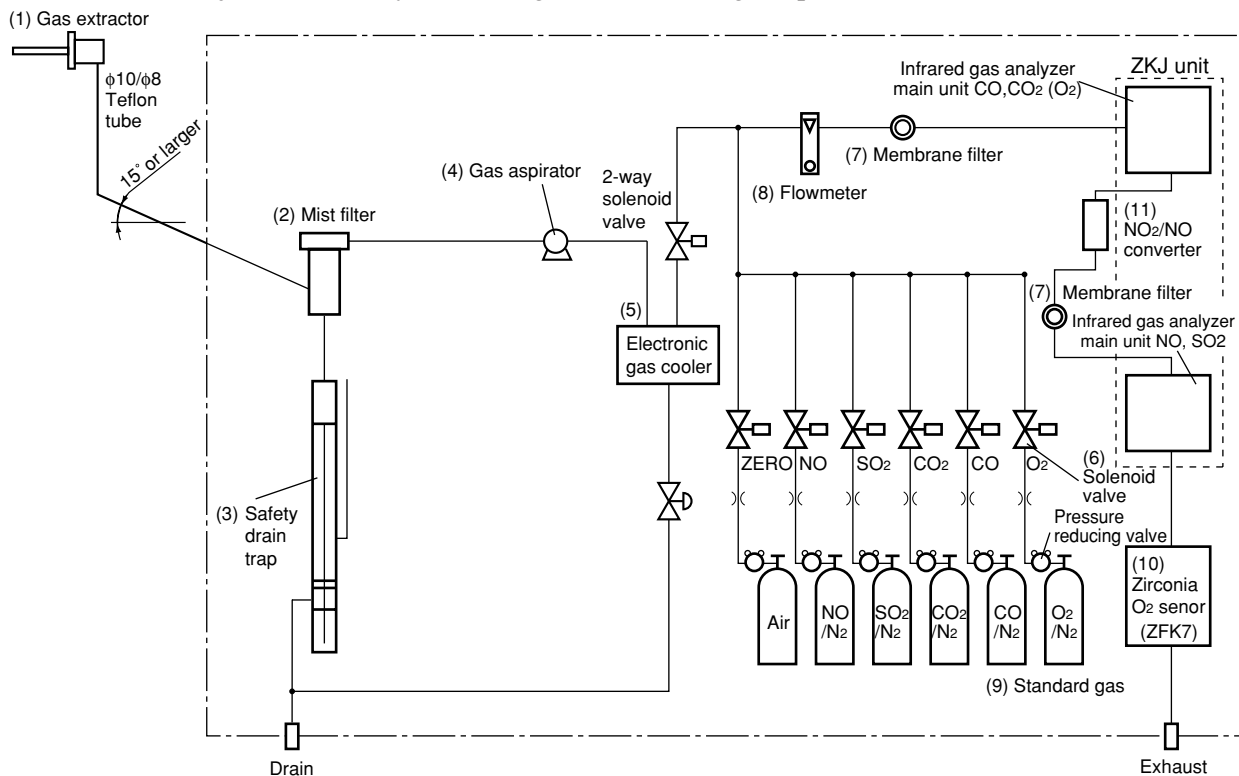

Name	Description	Name	Description
(1) Gas extractor	Gas extractor with a heating type stainless steel filter of standard mesh 40 μ m	(8) Flowmeter	Adjusts and monitors the flow rate of sample gas.
(2) Mist filter	Removes drain, mist, and dust.	(9) Standard gas	Reference gas used for calibrating zero and span of the analyzer. Total 6 cylinders required for zero gas air, span gas NO, SO ₂ , CO, CO ₂ and O ₂ .
(3) Safety drain trap	The safety drain trap divided into two rooms for positive and negative pressure. It monitors and adjusts the sample gas pressure.	(10) Zirconia O ₂ sensor	External zirconia oxygen sensor used for measuring the oxygen concentration in sample gas. (This is not necessary in case when O ₂ sensor is built-in.)
(4) Gas aspirator	For aspiration of sample gas	(11) NO ₂ /NO converter	Added to NO _x analyzer. A special catalyst material for efficient conversion of NO ₂ gas to NO is used.
(5) Electronic gas cooler	Dries the moisture in sample gas to a dew point of approx. 2°C.		
(6) Solenoid valve	Used for introducing calibration gas.		
(7) Membrane filter	PTFE filter used to eliminate fine dust particles and permit monitoring of dust adhering condition on the front panel of the gas analyzer.		

3.5 Wiring

3.5.1 Power inlet

The power inlet is provided at the rear panel.

Connect supplied power cable to this power inlet.

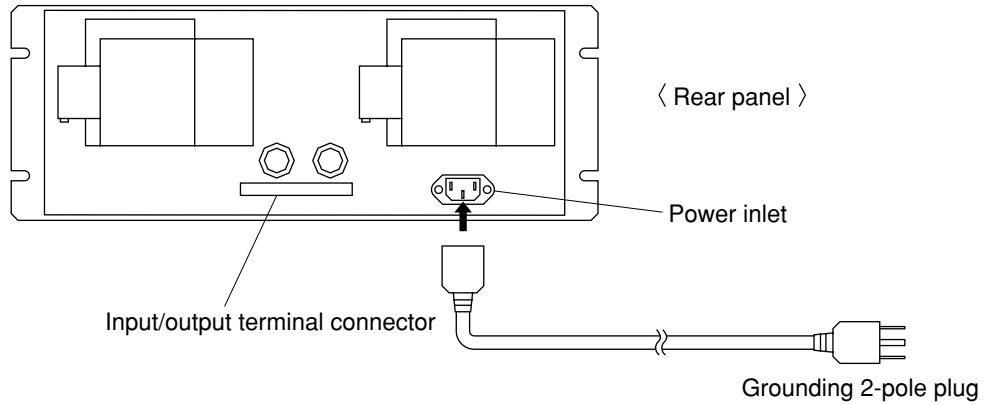

When noise source is in the vicinity

- Avoid installing this instrument near an electrical unit (high frequency furnace or electric welder) that generates much electrical noise. If using the instrument near such a noise generating unit is unavoidable, use a different power line to avoid noise.
- Mount a noise suppressor such as varistor or spark killer as shown at right figure to the noise generating unit when noise is generated from relays or solenoid valves. Mount the suppressor near the noise generating source, or it will have no effect.

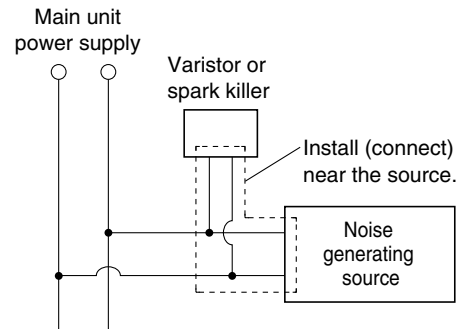

3.5.2 Input/output terminal module

This analyzer should be connected to the input/output terminal module by supplied exclusive cable.

Plug this cable connector into the receptacle at the rear panel of the analyzer and the receptacle on the PC board of the input/output module.

Connect the exclusive cable so that the ferrite core attached to the cable comes to the analyzer side.

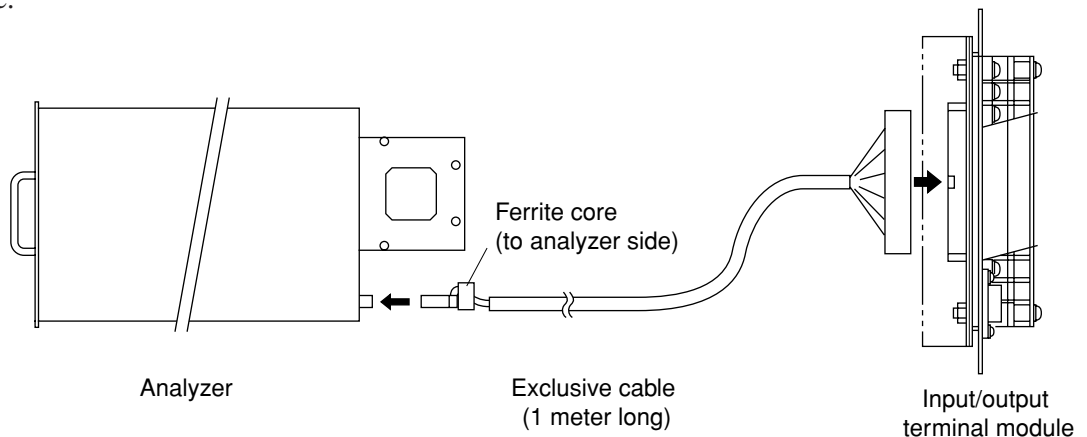

(1) Analog output signal (AO): terminal block 1 (1) to (20), terminal block 2 (3) to (6)

Output signal : 4 to 20 mADC or 0 to 1 VDC (selected when ordering)

Non-insulated output

Allowable load : 4 to 20 mADC, 550 Ω or less

0 to 1 VDC, 100k Ω or more

- Analog output is provided from each terminal corresponding to the channel displayed in the measurement screen.

All of analog output signals for the instrument are not isolated. It is recommended to isolate signals individually to prevent interference from unnecessary signals or to prevent external interference, especially leading the cable of more than 30 meters or to outdoor.

(2) O₂ sensor input: terminal block 2 (1) – (2)

Input signal:

External zirconia O₂ analyzer : Zirconia O₂ sensor signal (Fuji ZFK7 output)

External O₂ analyzer : 0 to 1 VDC (DC input resistor of 1M Ω or more)

- It is used when the external zirconia O₂ analyzer or external O₂ analyzer is specified as order.
- To connect to the output of the external Zirconia analyzer or external O₂ analyzer prepared separately.
- In case of an external O₂ analyzer, input a signal of 0 to 1 VDC with respect to O₂ full scale of the analyzer.
- In case of built-in O₂ analyzer, do not use the terminals.

O₂ sensor input is not isolated. It is recommended to isolate when an external O₂ analyzer is installed apart from this analyzer. Zirconia O₂ sensor Fuji make ZFK7 should be installed at a location that is as close to this instrument as possible.

(3) Contact input (DI): terminal block 2 (11) to (20), terminal block 3 (5) to (10)

- It is for a contact input at no voltage. An input is provided when switching to short circuit (on) or open (off).
- No voltage is applied to the terminals.

(4) Contact output (DO): terminal block 3 (11) to (20), terminal block 4 and terminal block 5

- Contact rating: 250VAC/2A, load resistance
- An output is for a relay contact output. An output is provided when switching to conductive (on) or open (off).

Wiring of analog output signal, O₂ sensor input and contact input should be fixed separately from the wiring of power supply and contact output.

Note) To avoid the effect of noise generated from external units, be sure to ground the analyzer main unit. Continue between the I/O module mounting plate and the panel and connect the panel casing to the same ground as the analyzer.

(5) List of terminal blocks

Terminal block 1
<TN1>

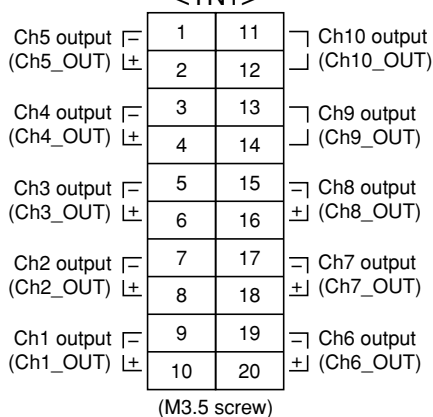

Terminal block 2
<TN2>

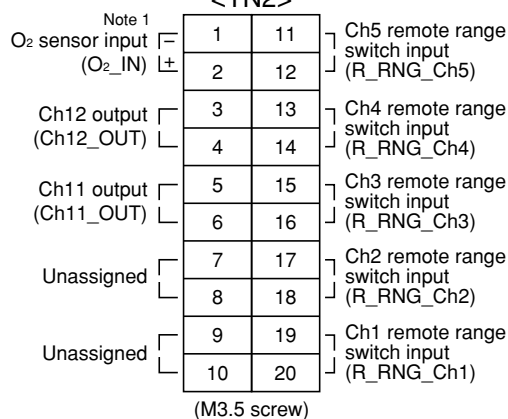

Note 1 : For external O₂ sensor input.

Terminal block 3
<TN3>

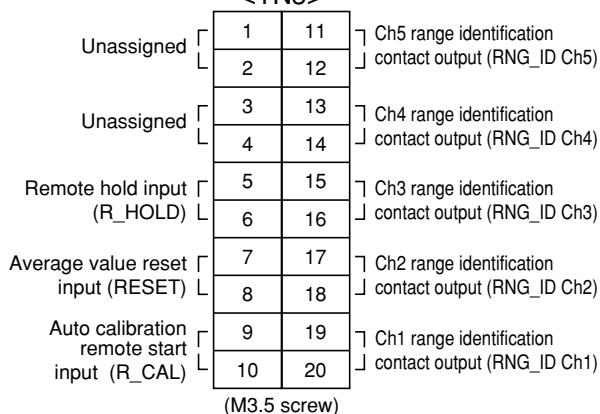

Terminal block 4
<TN4>

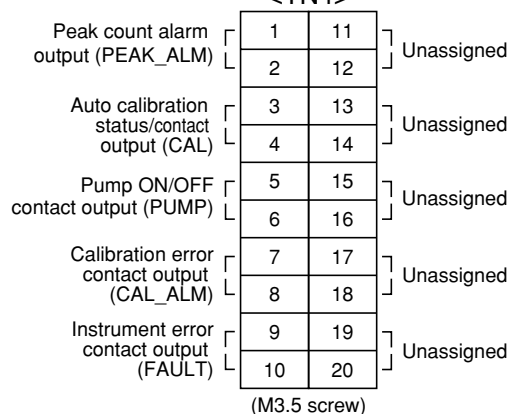

Terminal block 5
<TN5>

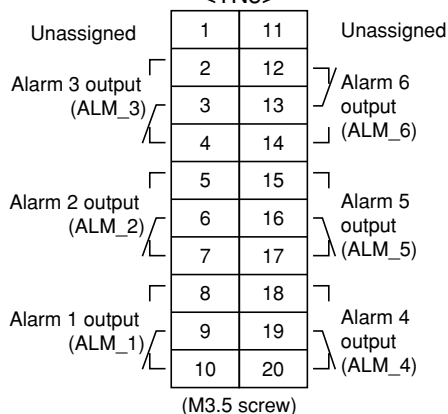

Connector
<CN3>

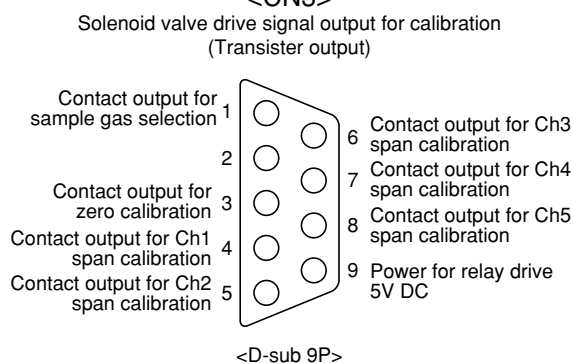

Connector
<CN2>

For serial communication (D-Sub9pin)

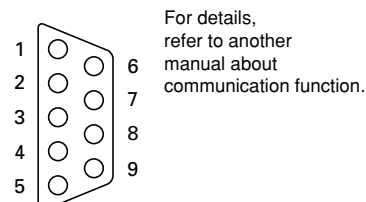

(6) Description on terminal block

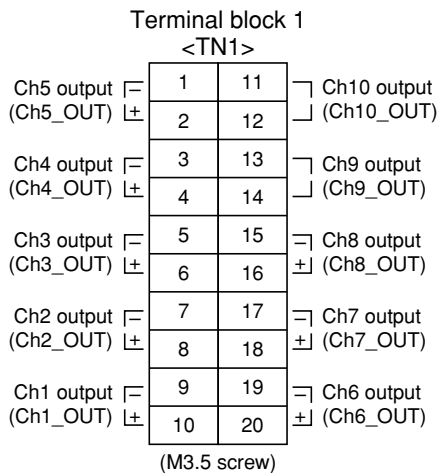

Terminal block 1 <TN1>

Terminal block for analog output (non-isolated output)

Between 1–2 : Ch5 output

Between 3–4 : Ch4 output

Between 5–6 : Ch3 output

Between 7–8 : Ch2 output

Between 9–10 : Ch1 output

Between 11–12 : Ch10 output

Between 13–14 : Ch9 output

Between 15–16 : Ch8 output

Between 17–18 : Ch7 output

Between 19–20 : Ch6 output

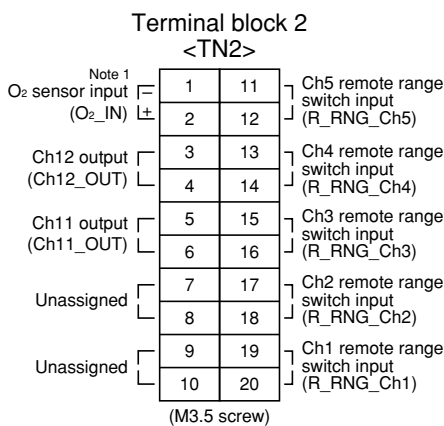

Terminal block 2 <TN2>

Between 1–2 : O₂ sensor input
(For input of Fuji's zirconia oxygen sensor or externally oxygen sensor. Must not be used unless external O₂ sensor is provided.)

Between 3–4 : Ch12 output

Between 5–6 : Ch11 output

Between 7–10 : For internal connection. Must not be wired. (Must not be used as junction terminal).

Between 11–12: Ch5 remote range switch input

Between 13–14: Ch4 remote range switch input

Between 15–16: Ch3 remote range switch input

Between 17–18: Ch2 remote range switch input

Between 19–20: Ch1 remote range switch input

Note 1: For external O₂ sensor input.

Action of remote range switch
High range is selected when open. Low range is selected when short-circuited. For details of action, see "Item 6.1 Switch of range."

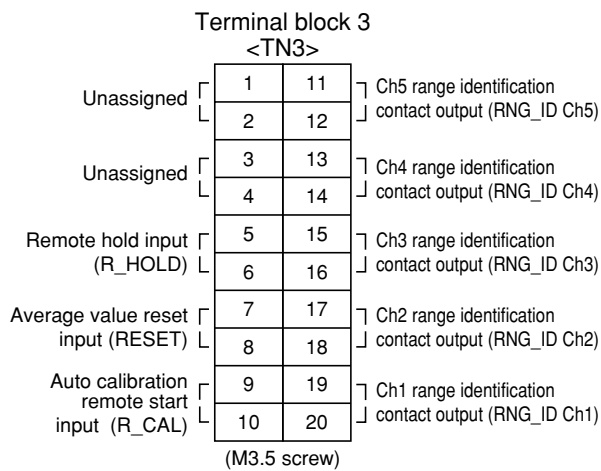

Terminal block 3 <TN3>

Between 1–4 : For internal connection. Must not be wired. (Must not be used as junction terminal.)

Between 5–6 : Remote hold input. No hold when open. Output hold when short-circuited.

For details, refer to “Item 6.7
Parameter setting, Output Hold”.

Between 7–8 : Average value reset input. short-circuiting the contact input (for at 1.5 sec min.) resets O₂ average and O₂ converted average simultaneously. Opening it restarts the average value.

For details, refer to “Item 6.7
Parameter setting, Average Value Resetting”

Between 9–10 : Automatic calibration remote start input

After shorting for 1.5 sec. or more, automatic calibration is started by the opening input whether the automatic calibration setting is ON/OFF.

For details, refer to “Item 6.4
Setting of auto calibration”

Between 11–12: Ch5 range identification contact output

Between 13–14: Ch4 range identification contact output

Between 15–16 Ch3 range identification contact output

Between 17–18: Ch2 range identification contact output

Between 19–20: Ch1 range identification contact output

Action of range identification signal
Range identification contact is conductive at low range and open at high range.

Terminal block 4 <TN4>			
Peak count alarm output (PEAK_ALM)	1	11	Unassigned
	2	12	
Auto calibration status/contact output (CAL)	3	13	Unassigned
	4	14	
Pump ON/OFF contact output (PUMP)	5	15	Unassigned
	6	16	
Calibration error contact output (CAL_ALM)	7	17	Unassigned
	8	18	
Instrument error contact output (FAULT)	9	19	Unassigned
	10	20	

(M3.5 screw)

Terminal 4 <TN4>

Between 1–2 : Peak count alarm contact output
It is conductive when peak count exceeds the setting time. It remains open below the setting time. For setting and operation, refer to “Item 6.6 Peak alarm setting”.

Between 3–4 : Contact output of auto calibration status
When the auto calibration is carried out, it is conductive. Remains open otherwise.

Between 5–6 : Pump ON/OFF contact output
Used when turning ON/OFF the pump. It is open during auto and manual calibration status and conductive during measurement.

Between 7–8 : Calibration error contact output
It is conductive when an error occurs during zero calibration or span calibration. It is normally open.

Between 9–10 : It is conductive when an error occurs to the analyzer unit. It is normally open.

Between 11–20: For internal connection, wiring is not allowed. (Do not use it as junction terminal).

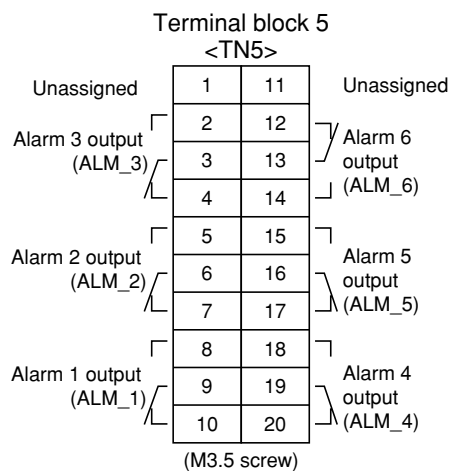

Terminal 5 <TN5>

Between 2, 3 and 4 : Alarm 3 output
When the output exceeds the set value, it is conductive between 2 and 3, and open between 3 and 4. Otherwise, it is open between 2 and 3 and conductive between 3 and 4.

Between 5, 6 and 7 : Alarm 2 output
When the output exceeds the set value, it is conductive between 5 and 6, and open between 6 and 7. Otherwise, it is open between 5 and 6, and conductive between 6 and 7.

Between 8, 9 and 10 : Alarm 1 output
When the output exceeds the set value, it is conductive between 8 and 9, and open between 9 and 10. Otherwise, it is open between 8 and 9.

Between 12, 13 and 14: Alarm 6 output
When the analyzer unit is turned ON, it is conductive between 12 and 13, and open between 13 and 14. When the analyzer unit is turned OFF, it is open between 12 and 13, and conductive between 13 and 14.

Between 15, 16 and 17: Alarm 5 output
When the output exceeds the set value, it is conductive between 15 and 16, and open between 16 and 17. Otherwise, it is open between 15 and 16, and conductive between 16 and 17.

Between 18, 19 and 20: Alarm 4 output
When the output exceeds the set value, it is conductive between 18 and 19, and open between 19 and 20. Otherwise, it is open between 18 and 19, and conductive between 19 and 20.
For detailed action of the alarm contact, refer to “Item 6.3 Alarm setting”.

Connector <CN3>

Solenoid valve drive signal output for calibration

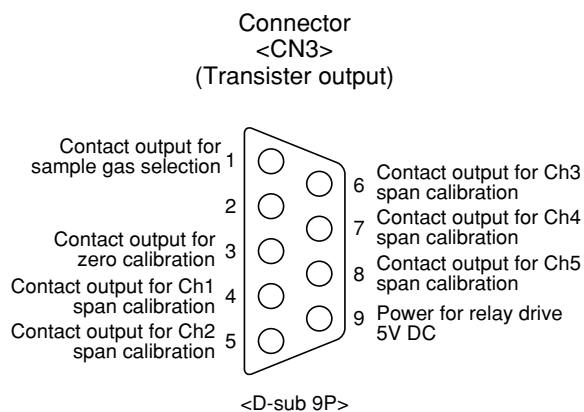

Connector <CN3> provides outputs in combination with calibration action during auto calibration and manual calibration.

An output is from a transistor (ratings: 5V/50mA).

A transistor is turned ON before starting each calibration.

Sample selection output is ON during measurement and OFF during calibration.

If calibration is not performed, the other transistors are OFF.

In case of auto calibration, sequential output is ON/OFF according to the setting.

Refer to “Item 6.4 Setting of auto calibration”.

Note) No. 9 pin is for solenoid valve ON/OFF relay drive power (5V DC/0.5A, max).

Use No. 9 with reference to the diagram.

Example of using solenoid valve drive signal output for calibration

<Electrical system>

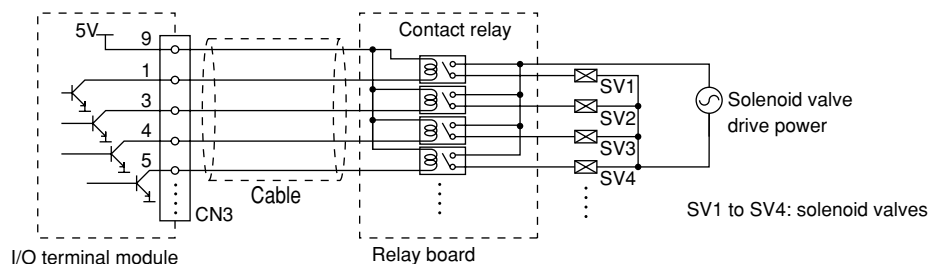

<Gas sampling system>

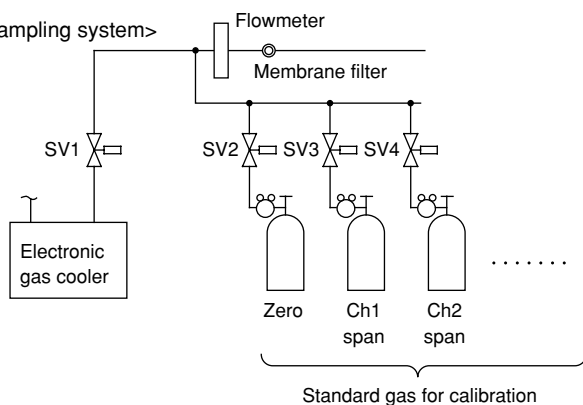

Refer to “Item 3.4.6 Example configuration of gas sampling system”.

Relay board and exclusive cable (D-sub 9p straight cable: 1.5 meters) are available on request.

(7) Timing of solenoid valve drive signal for calibration

1) Manual calibration (See “Item 6.9 Calibration”.)

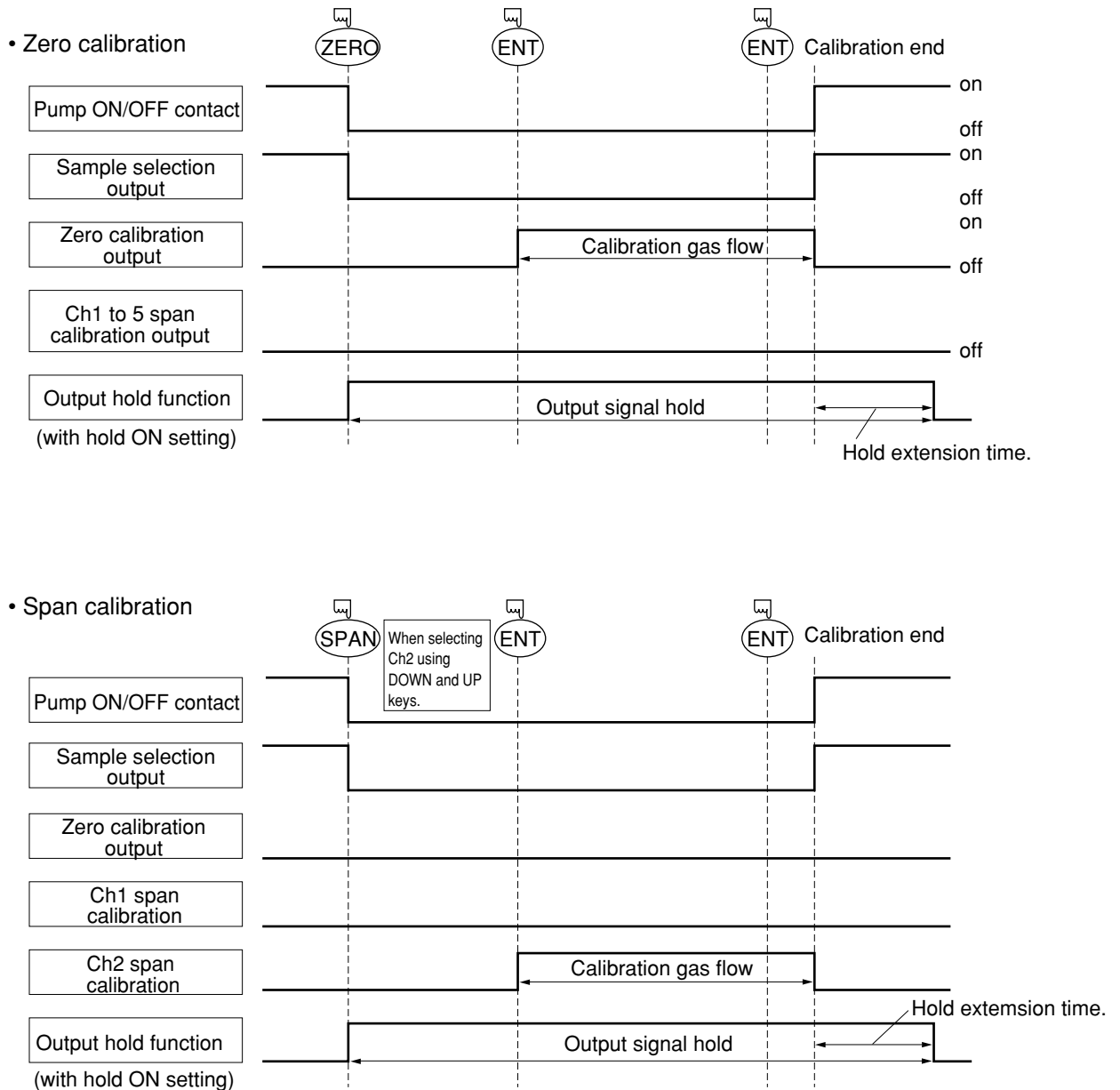

2) In case of automatic calibration (example shown in Item 6.4.1, Automatic calibration settings)

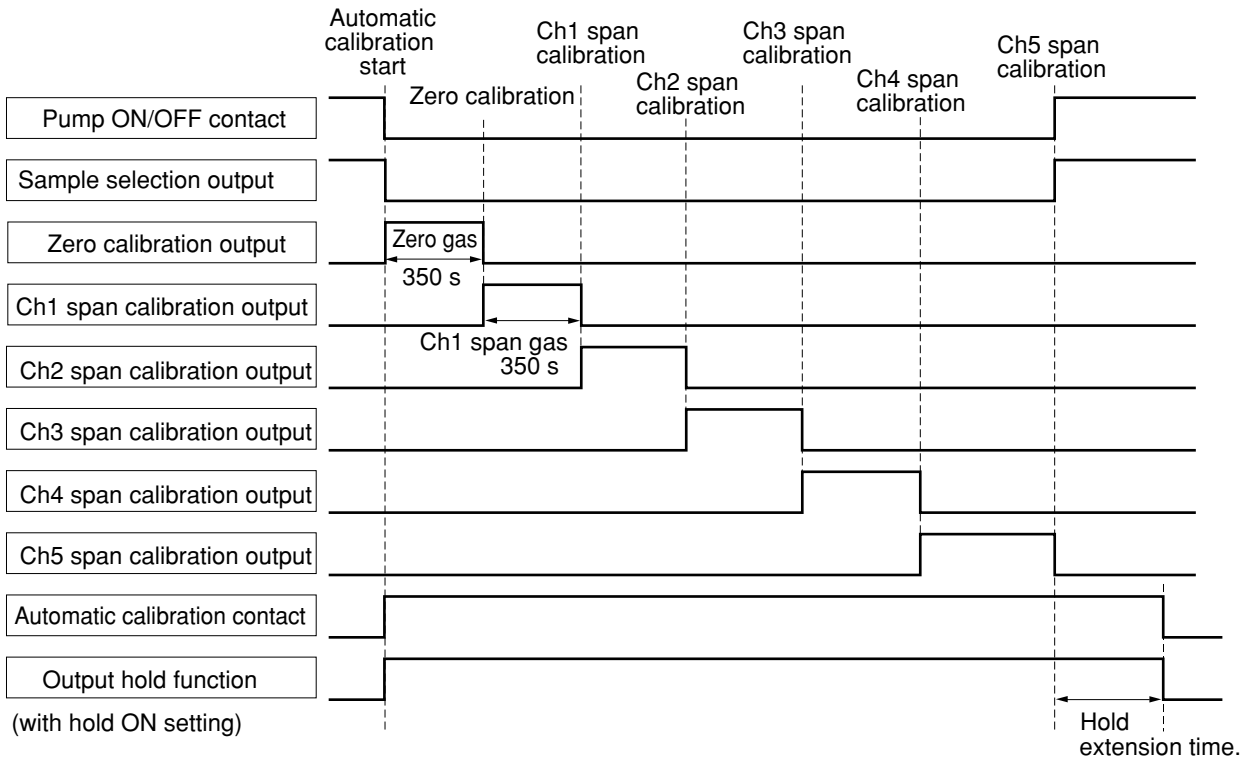

4. OPERATION

4.1 Preparation for operation

(1) Tube and wiring check

Double-check if tubes of the gas sampling and exhaust ports are correctly connected.

Double-check for proper wiring.

4.2 Warm-up operation and regular operation

(1) Operation procedure

- 1) Turn ON the power switch on the front panel of the analyzer unit.
The measurement screen appears on the front display panel in 1 or 2 seconds.
- 2) Wait for about 4 hours until the instrument is warmed up.
About 4 hours are required until the instrument allows accurate measurement.

Note) When in warm-up, the concentration reading may be beyond.

upper limit of range or

lower limit of range.

But, it is not an error.

- 3) Setting of various set values
Perform the various settings according to “Chapter 6. Setting and Calibration”.
- 4) Zero calibration and span calibration
Perform zero calibration and span calibration after warm-up operation.
Refer to “Chapter 6.9. Calibration”.
- 5) Introduction and measurement of measuring gas
Introduce the measuring gas into the analyzer unit before starting measurement.

5. DESCRIPTION OF DISPLAY AND OPERATION PANELS

This section describes the display unit and operation panel of the analyzer unit. It also explains the name and description of function on the operation panel.

5.1 Name and description of operation panel

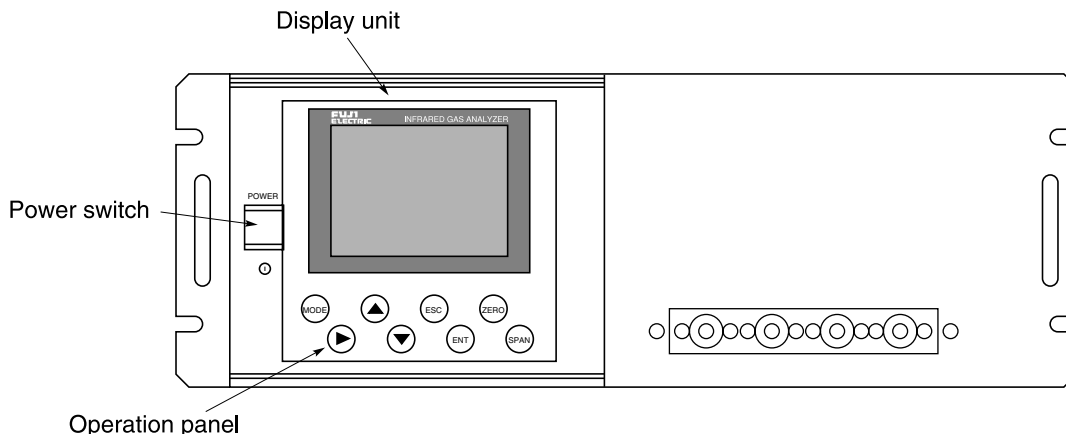

- Display unit: The measurement screen and the setting items are displayed.
- Operation panel: The configuration is as shown below.

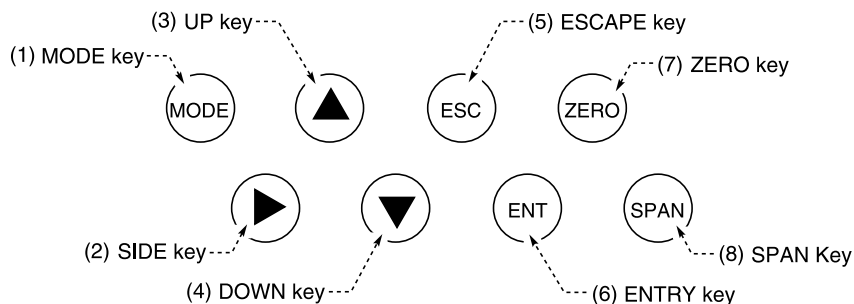

Fig. 5-1

Name	Description	Name	Description
(1) MODE key	Used to switch the mode.	(5) ESC key	Used to return to a previous screen or cancel the setting midway.
(2) SIDE key	Used to change the selected item (by moving the cursor) and numeral digit.	(6) ENT key	Used for confirmation of selected items or values, and for execution of calibration.
(3) UP key	Used to change the selected item (by moving the cursor) and to increase numeral value.	(7) ZERO key	Used for zero calibration.
(4) DOWN key	Used to change the selected item (by moving the cursor) and to decrease numeral value.	(8) SPAN key	Used for span calibration.

5.2 Overview of display and operation panels

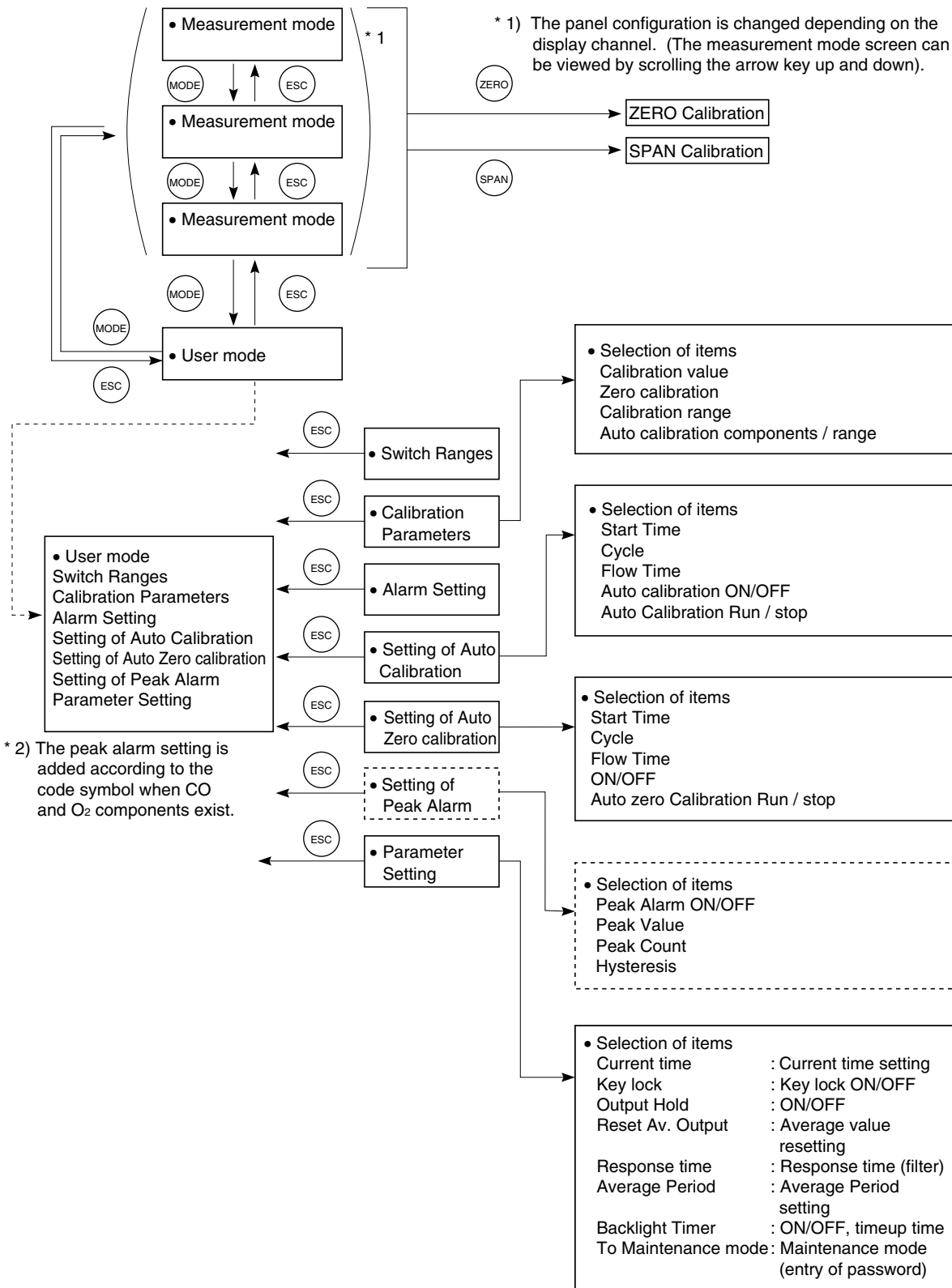

Fig. 5-2

5.3 Outline of display screen

(1) Measurement mode screen (appears when the power is turned ON)

The measurement screen depends on the number of components. The following screen configuration as shown as an example is for NO, SO₂, CO₂, CO and O₂ (output: 12 channel).

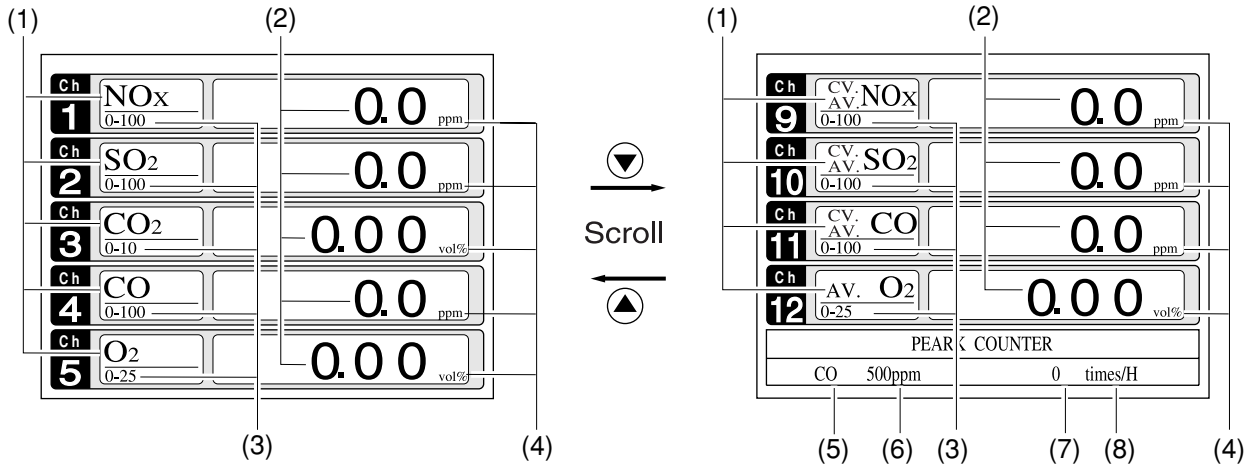



Fig. 5-3 Name and function of measurement mode screen

* For outputs of more than 5 channels, scroll the arrow key  or  to view.

No.	Name	Function	No.	Name	Description
(1)	Component display	Displays component of instantaneous value, converted instantaneous value, converted average value, etc.	(5)	Peak alarm component display	Displays peak alarm component.
(2)	Concentration display	Displays measured value of concentration.	(6)	Peak alarm concentration display	Displays peak alarm concentration display. (Upper limit value)
(3)	Range display	Displays range values.	(7)	Peak alarm times	Displays the alarm times exceeding the peak value.
(4)	Unit display	Displays unit with ppm and vol%.	(8)	Peak alarm unit display	Displays units of peak alarm with times/H.

- **Instantaneous value and concentration value:**

The concentration display of Ch (component) where sampling components such as “CO₂”, “CO” or “O₂ are displayed in the component display, indicates current concentration values of the measured components contained in gas that is now under measurement.

- **O₂ conversion concentration values:**

Ch components where “cv**” is displayed as “cv CO” in the component display are calculated from the following equation, by setting sampling components, O₂ instantaneous/concentration values and O₂ conversion reference value (see item 6.8).

$$\text{Conversion output} = \frac{21 - O_n}{21 - O_s} \times C_s$$

On: The value of the O₂ conversion reference value (Value set by application)

Os: Oxygen concentration (%)

Cs: Concentration of relevant measured component. Note that Os does not exceed the O₂ limit value set in “Other Parameter” in “6.8 Maintenance mode.”

The converted sampling components are NO_x, SO₂ and CO only.

- **O₂ conversion concentration average value:**

In the Ch (component) and O₂ average value where “^{CV}_{AV}***” is displayed as “^{CV}_{AV}CO” in the component display, a value obtained by averaging O₂ conversion concentration value or O₂ average value in a fixed time is output every 30 seconds.

Averaging time can be changed between 1 minute and 59 minutes or 1 hour and 4 hours according to the average time settings (See 6.7, Parameter setting).

(The set time is displayed as “1h”, for instance, in the range display.)

* The measurement ranges of O₂ conversion concentration value and O₂ conversion concentration average value are the same as that of the measuring components. Also, the measurement range of O₂ average value is the same as that of O₂.

(2) Setting/selection screen

The setting/selection screen is configured as shown below:

- In the status display area, the current status is displayed.
- In the message display area, messages associated with operation are displayed.
- In the setting item and selection item display area, items or values to be set are displayed, as required. To work on the area, move the cursor to any item by using UP, DOWN and SIDE keys.

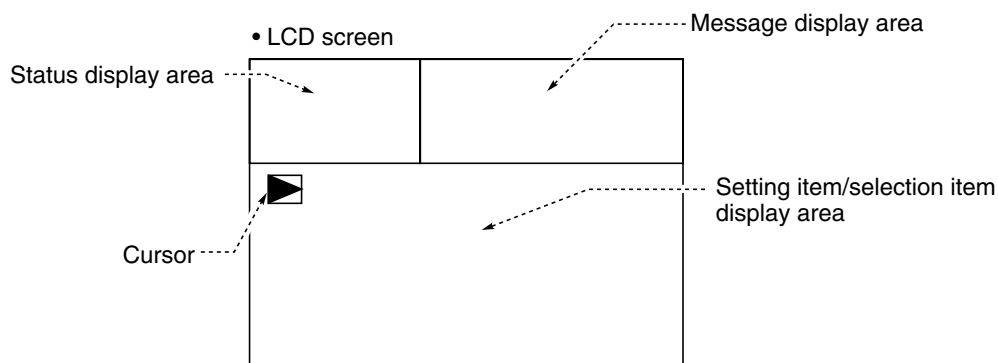

Fig. 5-4



(3) Contents of measured channel (Ch)

The following table gives measurement channels and their contents according to the symbols.

Code symbol			Contents
5th digit	6th digit	22nd digit	
P	Y	Y	Ch1: NO
A	Y	Y	Ch1: SO ₂
D	Y	Y	Ch1: CO ₂
B	Y	Y	Ch1: CO
E	Y	Y	Ch1: CH ₄
F	Y	Y	Ch1: NO, Ch2: SO ₂
H	Y	Y	Ch1: NO, Ch2: CO
G	Y	Y	Ch1: CO ₂ , Ch2: CO
L	Y	Y	Ch1: NO, Ch2: SO ₂ , Ch3: CO
M	Y	Y	Ch1: NO, Ch2: SO ₂ , Ch3: CO ₂ , Ch4: CO
P	A, B, C	A	Ch1: NO _x , Ch2: O ₂ , Ch3: Converted NO _x , Ch4: Converted NO _x average, Ch5: O ₂ average
A	A, B, C	A	Ch1: SO ₂ , Ch2: O ₂ , Ch3: Converted SO ₂ , Ch4: Converted SO ₂ average, Ch5: O ₂ average
B	A, B, C	A	Ch1: CO, Ch2: O ₂ , Ch3: Converted CO, Ch4: Converted CO average, Ch5: O ₂ average
F	A, B, C	A	Ch1: NO _x , Ch2: SO ₂ , Ch3: O ₂ , Ch4: Converted NO _x , Ch5: Converted SO ₂ , Ch6: Converted NO _x average, Ch7: Converted SO ₂ average, Ch8: O ₂ average
H	A, B, C	A	Ch1: NO _x , Ch2: CO, Ch3: O ₂ , Ch4: Converted NO _x , Ch5: Converted CO, Ch6: Converted NO _x average, Ch7: Converted CO average, Ch8: O ₂ average
G	A, B, C	A	Ch1: CO ₂ , Ch2: CO, Ch3: O ₂ , Ch4: Converted CO, Ch5: Converted CO average, Ch6: O ₂ average
L	A, B, C	A	Ch1: NO _x , Ch2: SO ₂ , Ch3: CO, Ch4: O ₂ , Ch5: Converted NO _x , Ch6: Converted SO ₂ , Ch7: Converted CO, Ch8: Converted NO _x average, Ch9: Converted SO ₂ average, Ch10: Converted CO average, Ch11: O ₂ average
M	A, B, C	A	Ch1: NO _x , Ch2: SO ₂ , Ch3: CO ₂ , Ch4: CO, Ch5: O ₂ , Ch6: Converted NO _x , Ch7: Converted SO ₂ , Ch8: Converted CO, Ch9: Converted NO _x average, Ch10: Converted SO ₂ average, Ch11: Converted CO average, Ch12: O ₂ average
B	A, B, C	B	Ch1: CO, Ch2: O ₂
H	A, B, C	B	Ch1: NO, Ch2: CO, Ch3: O ₂
G	A, B, C	B	Ch1: CO ₂ , Ch2: CO, Ch3: O ₂
L	A, B, C	B	Ch1: NO, Ch2: SO ₂ , Ch3: CO, Ch4: O ₂
M	A, B, C	B	Ch1: NO, Ch2: SO ₂ , Ch3: CO ₂ , Ch4: CO, Ch5: O ₂
B	A, B, C	C	Ch1: CO, Ch2: O ₂ , Ch3: Converted CO, Ch4: Converted CO average, Ch5: O ₂ average
H	A, B, C	C	Ch1: NO _x , Ch2: CO, Ch3: O ₂ , Ch4: Converted NO _x , Ch5: Converted CO, Ch6: Converted NO _x average, Ch7: Converted CO average, Ch8: O ₂ average
G	A, B, C	C	Ch1: CO ₂ , Ch2: CO, Ch3: O ₂ , Ch4: Converted CO, Ch5: Converted CO average, Ch6: O ₂ average
L	A, B, C	C	Ch1: NO _x , Ch2: SO ₂ , Ch3: CO, Ch4: O ₂ , Ch5: Converted NO _x , Ch6: Converted SO ₂ , Ch7: Converted CO, Ch8: Converted NO _x average, Ch9: Converted SO ₂ average, Ch10: Converted CO average, Ch11: O ₂ average
M	A, B, C	C	Ch1: NO _x , Ch2: SO ₂ , Ch3: CO ₂ , Ch4: CO, Ch5: O ₂ , Ch6: Converted NO _x , Ch7: Converted SO ₂ , Ch8: Converted CO, Ch9: Converted NO _x average, Ch10: Converted SO ₂ average, Ch11: Converted CO average, Ch12: O ₂ average
Q	Y	Y	Ch1:N ₂ O
R	Y	Y	Ch1:N ₂ O, Ch2:CO ₂
S	Y	Y	Ch1:NO, Ch2:N ₂ O, Ch3:CO ₂
T	Y	Y	Ch1:SO ₂ , Ch2:N ₂ O, Ch3:CO ₂
U	Y	Y	Ch1:N ₂ O, Ch2:CO ₂ , Ch3:CO
V	Y	Y	Ch1:CH ₄ , Ch2:N ₂ O, Ch3:CO ₂
W	Y	Y	Ch1:NO, Ch2:SO ₂ , Ch3:N ₂ O, Ch4:CO ₂
S	A, B, C	Y	Ch1:NO, Ch2:N ₂ O, Ch3:CO ₂ ,Ch4:O ₂
T	A, B, C	Y	Ch1:SO ₂ , Ch2:N ₂ O, Ch3:CO ₂ ,Ch4:O ₂
U	A, B, C	Y, B	Ch1:N ₂ O, Ch2:CO ₂ , Ch3:CO, Ch4:O ₂
V	A, B, C	Y	Ch1:CH ₄ , Ch2:N ₂ O, Ch3:CO ₂ ,Ch4:O ₂
W	A, B, C	Y	Ch1:NO, Ch2:SO ₂ , Ch3:N ₂ O, Ch4:CO ₂ , Ch5:O ₂
S	A, B, C	A	Ch1:NO _x , Ch2:N ₂ O, Ch3:CO ₂ , Ch4:O ₂ , Ch5:Converted NO _x , Ch6:Converted NO _x average, Ch7:O ₂ average
T	A, B, C	A	Ch1:SO ₂ , Ch2:N ₂ O, Ch3:CO ₂ ,Ch4:O ₂ , Ch5:Converted SO ₂ , Ch6:Converted SO ₂ average, Ch7:O ₂ average
U	A, B, C	A, C	Ch1:N ₂ O, Ch2:CO ₂ , Ch3:CO, Ch4:O ₂ , Ch5:Converted CO, Ch6:Converted CO average, Ch7:O ₂ average
V	A, B, C	A	Ch1:CH ₄ , Ch2:N ₂ O, Ch3:CO ₂ ,Ch4:O ₂ ,Ch5:O ₂ average
W	A, B, C	A	Ch1:NO _x , Ch2:SO ₂ , Ch3:N ₂ O, Ch4:CO ₂ , Ch5:O ₂ , Ch6:Converted NO _x , Ch7:Converted SO ₂ , Ch8:Converted NO _x average, Ch9:Converted SO ₂ average, Ch10:O ₂ average

5.4 Basic operation

• Measurement mode

The measurement mode can be displayed up to 5 channels in a single screen. If 5 channels or more are to be displayed in a single screen, press the  or  key to scroll the channel one by one.

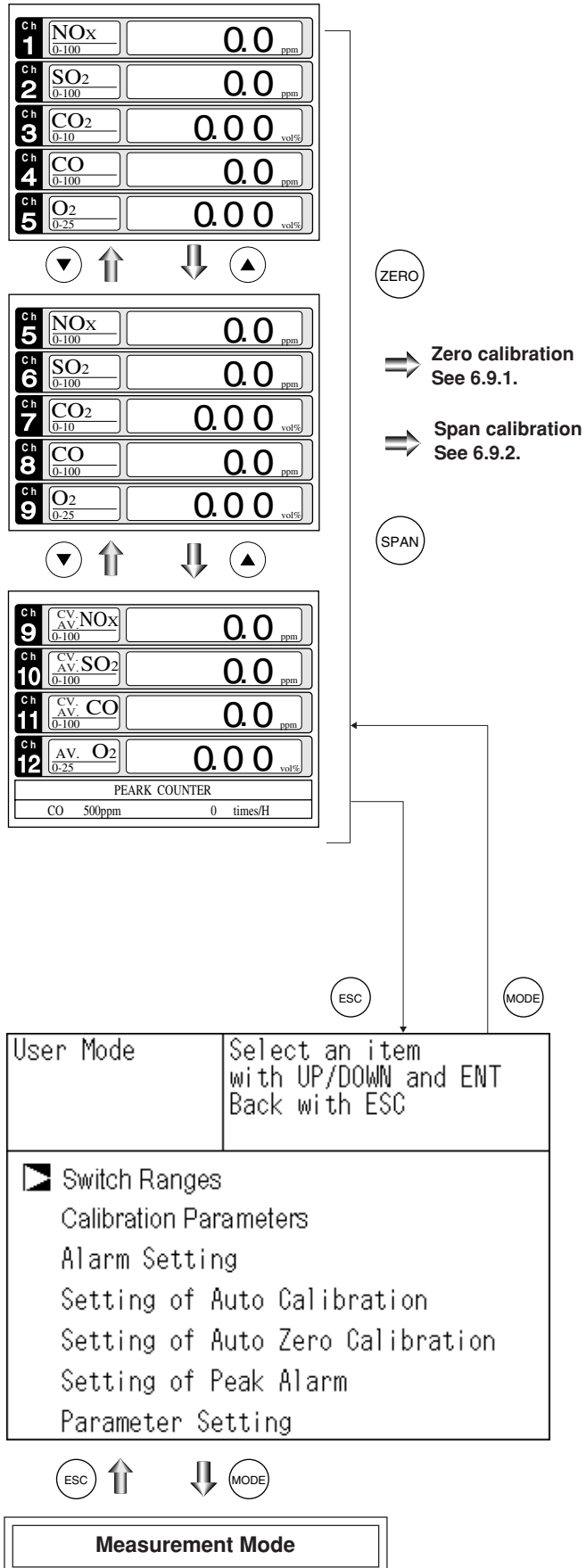

• User mode displays;

- Switch Ranges
- Calibration Parameters
- Alarm Setting
- Setting of Auto Calibration
- Setting of Auto Zero Calibration
- Setting of Peak Alarm
- Parameter Setting.







For the setting contents, refer to “Chapter 6. Setting and calibration”.



6. SETTING AND CALIBRATION

6.1 Switch of range

6.1.1 Setting of range switch mode

Set the range switch mode as follows.

- (1) Press the  key in measurement mode to display the User mode screen.
- (2) Move the cursor to “Switch Ranges” and press the  key.
- (3) The “Channel Selection” screen appears. Move the  cursor by pressing the  or the  key on the channel selection screen that appears, and select Ch (component).
- (4) Then press the  key.

- (5) Selected range switch mode is highlighted.
Press the  or the  key to select a desired switch mode.

Description of setting







MR: Select a desired range on this screen.
 RR: Select a desired range according to the remote range switch contact input.
 AR: Automatically switched from Range 1 to Range 2 when the measured concentration exceeds 90% of Range 1. Automatically switched from Range 2 to Range 1 when the measured concentration becomes smaller than 80% of Range 1.
 * Operation set for each Ch only can be performed.



- (6) Then press the  key to confirm the selection.
If “MR” is selected, the cursor moves to “Range Switch.”





↓ 

User Mode	Select an item with UP/DOWN and ENT Back with ESC
 Switch Ranges	Calibration Parameters Alarm Setting Setting of Auto Calibration Setting of Auto Zero Calibration Setting of Peak Alarm Parameter Setting

↓ 

Switch Range	Select Ch No. with UP / DOWN and ENT Back with ESC
 Ch1 NO _x MR	 Range1 0-100 ppm Range2 0-2000 ppm
Ch2 SO ₂ AR	 Range1 0-100 ppm Range2 0-2000 ppm
Ch3 CO ₂ RR	 Range1 0-10 vol% Range2 0-20 vol%
Ch4 CO MR	 Range1 0-100 ppm Range2 0-2000 ppm
Ch5 O ₂ MR	 Range1 0-10 vol% Range2 0-25 vol%

↓  () 

Switch Range	Select method of Switch ranges with UP / DOWN and ENT Back with ESC
Ch1 NO _x MR	 Range1 0-100 ppm Range2 0-2000 ppm
Ch2 SO ₂ AR	 Range1 0-100 ppm Range2 0-2000 ppm
Ch3 CO ₂ RR	 Range1 0-10 vol% Range2 0-20 vol%
Ch4 CO MR	 Range1 0-100 ppm Range2 0-2000 ppm
Ch5 O ₂ MR	 Range1 0-10 vol% Range2 0-25 vol%

↓ 

**Range switch
or previous screen**



6.1.2 Manual range switch

The range of the measured component can be switched manually as follows.

- (1) Select “MR” as range switch mode, and then press the  key.

Switch Range		Select method of Switch ranges with UP / DOWN and ENT Back with ESC
Ch1 NO _x	MR	▶ Range1 0-100 ppm Range2 0-2000 ppm
Ch2 SO ₂	AR	▶ Range1 0-100 ppm Range2 0-2000 ppm
Ch3 CO ₂	RR	▶ Range1 0-10 vol% Range2 0-20 vol%
Ch4 CO	MR	▶ Range1 0-100 ppm Range2 0-2000 ppm
Ch5 O ₂	MR	▶ Range1 0-10 vol% Range2 0-25 vol%



- (2) Move the highlight of the cursor to range selection, and then select a desired range by pressing the  or the  key. (The  mark indicates the currently selected range.)

Switch Range		Select range with UP/DOWN and ENT Back with ESC
Ch1 NO _x	MR	 Range1 0-100 ppm Range2 0-2000 ppm
Ch2 SO ₂	AR	▶ Range1 0-100 ppm Range2 0-2000 ppm
Ch3 CO ₂	RR	▶ Range1 0-10 vol% Range2 0-20 vol%
Ch4 CO	MR	▶ Range1 0-100 ppm Range2 0-2000 ppm
Ch5 O ₂	MR	▶ Range1 0-10 vol% Range2 0-25 vol%

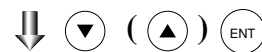

End of Range Switch

- (3) Then press the  key, and the measurement is carried out in the selected range.

Note) If “RR” or “AR” is selected as range switch mode, this operation cannot be performed.

The range for O₂ conversion value, O₂ conversion average value, and O₂ average value is automatically switched if corresponding instantaneous value range is switched.

To close the setting

Press the  key to end the setting of range switch mode or range switch operation or stop the operation in the middle, and the setting operation is made invalid and the previous screen appears.

Range identification contact operation

The range identification contact output corresponding to each Ch (component) is conductive when Range 1 is selected, and open when Range 2 is selected, which is applicable to any of the range switch mode selected.





Note that even if the range is switched during the hold of measurement value by remote hold contact input or the hold of measurement value at the time of calibration, the range identification contact output maintains the contact state immediately before the hold. After stop of the hold, the contact state of the current range is resumed.



6.2 Calibration setting

This mode is used to set calibration concentration and actions. The calibration setting involves calibration concentration, zero calibration, calibration range and auto calibration component/range.



6.2.1 Setting of calibration concentration





It allows you to set concentrations of the standard gas (zero and span) of each channel used for calibration.

- (1) During measurement, press the  key to display the User mode.
- (2) Point the cursor to “Calibration Parameters” by pressing the  or  key. Press the  key.



 





User Mode	Select an item with UP/DOWN and ENT Back with ESC
Switch Ranges <input checked="" type="checkbox"/> Calibration Parameters Alarm Setting Setting of Auto Calibration Setting of Auto Zero Calibration Setting of Peak Alarm Parameter Setting	

- (3) In the “Calibration Parameters” screen that appears, point the cursor to “Calibration Value” by pressing the  or  key. Press the  key.



  () 

Cal. Parameters	Select an item with UP/DOWN and ENT Back with ESC
<input checked="" type="checkbox"/> Calibration Valve About ZERO Calibration About Calibration Range Auto Calibration Components / Range	

- (4) In the “Calibration Concentration Ch Selection” screen that appears, point the cursor to Ch you want to set by using the  or  key. Press the  key.

  () 

Cal. Settings	Select Ch No. for setting calibration value		
Cal. Value			
CH	RANGE	ZERO	SPAN
<input checked="" type="checkbox"/> Ch1	0-100ppm	+0000.0	0100.0
NO _x	0-2000ppm	+00000	02000
Ch2	0-100ppm	+0000.0	0100.0
SO ₂	0-2000ppm	+00000	02000
Ch3	0-10vol%	+000.00	010.00
CO ₂	0-20vol%	+000.00	020.00
Ch4	0-100ppm	+0000.0	0100.0
CO	0-2000ppm	+00000	02000
Ch5	0-10vol%	21.00	01.00
O ₂	0-25vol%	21.00	01.00

  () 

- (5) In the “Calibration Concentration Selection” screen that appears, select any concentration item you want to set by pressing the , key.

Then press the key, and the selected value is highlighted.

Cal. Settings		Select setting value	
CH	RANGE	ZERO	SPAN
Ch1 NO _x	0-100ppm	+0000.0	0100.0
	0-2000ppm	+00000	02000
Ch2 SO ₂	0-100ppm	+0000.0	0100.0
	0-2000ppm	+00000	02000
Ch3 CO ₂	0-10vol%	+000.00	010.00
	0-20vol%	+000.00	020.00
Ch4 CO	0-100ppm	+0000.0	0100.0
	0-2000ppm	+00000	02000
Ch5 O ₂	0-10vol%	21.00	01.00
	0-25vol%	21.00	01.00

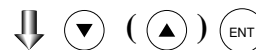

- (6) In the “Calibration Concentration Value Setting” screen that appears, enter calibration gas concentration values (zero and span). For value entry, press the or key, and a 1-digit value increases or decreases. By pressing the , the digit moves. After setting, save the entry by pressing the key. The saved value becomes valid from the next calibration process.

Note) Enter settings that correspond to each range. If zirconia type is used as O₂ sensor, select 21.00 for the field of Zero (when air is used), and select the concentration listed on the cylinder if the air contained in a cylinder is used.

Cursor for setting value

Cal. Settings		Set calibration value	
CH	RANGE	ZERO	SPAN
Ch1 NO _x	0-100ppm	+0000.0	0100.0
	0-2000ppm	+00000	02000
Ch2 SO ₂	0-100ppm	+0000.0	0100.0
	0-2000ppm	+00000	02000
Ch3 CO ₂	0-10vol%	+000.00	010.00
	0-20vol%	+000.00	020.00
Ch4 CO	0-100ppm	+0000.0	0100.0
	0-2000ppm	+00000	02000
Ch5 O ₂	0-10vol%	21.00	01.00
	0-25vol%	21.00	01.00



**End of Calibration
Concentration Setting**

To close the setting

To close the calibration concentration value setting process or cancel this mode midway, press the key. A previous screen will return.

Setting range of values

NO_x, SO₂, CO₂, CO, CH₄, N₂O external O₂ measurement and built-in paramagnetic O₂ sensor

Span gas: 1 to 105% of full scale (Full scale (FS) is the same as each range value.)





External Zirconia O₂ measurement

Zero gas: 5 to 25 vol%
Span gas: 0.01 to 5 vol%

The setting cannot be performed beyond the range.



6.2.2 Setting of manual zero calibration



When zero calibration is made manually, set either all measurement components should be calibrated simultaneously or each component should be calibrated while selecting one by one.

- (1) During measurement, press the  key to display the User mode.
- (2) Point the cursor to “Calibration Parameters” by pressing the  or  key. Press the  key.



↓ 



User Mode	Select an item with UP/DOWN and ENT Back with ESC
Switch Ranges <input checked="" type="checkbox"/> Calibration Parameters Alarm Setting Setting of Auto Calibration Setting of Auto Zero Calibration Setting of Peak Alarm Parameter Setting	

- (3) In the “Calibration Parameters” screen that appears, point the cursor to “About ZERO Calibration” by pressing the  or  key. Press the  key.

↓  () 

Cal. Parameters	Select an item with UP/DOWN and ENT Back with ESC
Calibration Valve <input checked="" type="checkbox"/> About ZERO Calibration About Calibration Range Auto Calibration Components / Range	

- (4) In the “Manual ZERO Calibration Ch Selection” screen that appears, point the cursor to Ch (component) you want to set by using the  or  key. Press the  key.

↓  () 

Cal. Settings ZERO Cal.	Select Ch No.		
<input checked="" type="checkbox"/> Ch1 NO _x	Range1 0-100 ppm	Range2 0-2000 ppm	at once
Ch2 SO ₂	Range1 0-100 ppm	Range2 0-2000 ppm	at once
Ch3 CO ₂	Range1 0-10 vol%	Range2 0-20 vol%	at once
Ch4 CO	Range1 0-100 ppm	Range2 0-2000 ppm	at once
Ch5 O ₂	Range1 0-10 vol%	Range2 0-25 vol%	each

↓  () 

(5) In the “Manual ZERO Calibration Selection” screen that appears, select “at once” or “each” by pressing the or key. When selecting “at once”, the Ch (components) to be set can be zero-calibrated at the same time. When selecting “each”, either of the Ch (components) to be selected is zero-calibrated. After setting, press the key.

Cal. Settings ZERO Cal.		Set each or both Ch at ZERO Calibration	
Ch1 NO _x	Range1 0-100 ppm Range2 0-2000 ppm		at once
Ch2 SO ₂	Range1 0-100 ppm Range2 0-2000 ppm		at once
Ch3 CO ₂	Range1 0-10 vol% Range2 0-20 vol%		at once
Ch4 CO	Range1 0-100 ppm Range2 0-2000 ppm		at once
Ch5 O ₂	Range1 0-10 vol% Range2 0-25 vol%		each

To close the setting

To close the manual zero calibration setting or to cancel this mode midway, press the key. A previous screen will return.

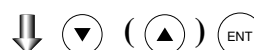

**End of
Manual Zero Calibration Setting**

Example

Whether “each” or “at once” can be determined for each Ch (component).

•Setting “each”

Select the Ch (component) on the manual zero calibration screen and then perform zero calibration.

•Setting “at once”

At a manual zero calibration, zero of Ch (components) for which “at once” was selected can simultaneously be calibrated.

* **When the cylinder air or atmospheric air is used for the zero gas, select “At once.”**

Manual Calibration screen

• When setting all components to “each”:

ZERO Cal.	ENT : Go on Calibration of selected Ch		ESC : Not calibration
Ch1 NO _x	▶Range1 0-100 ppm	▶ -2.1	
	▶Range2 0-2000 ppm		
Ch2 SO ₂	▶Range1 0-100 ppm	▶ -0.5	
	▶Range2 0-2000 ppm		
Ch3 CO ₂	▶Range1 0-10 vol%	▶ 0.00	
	▶Range2 0-20 vol%		
Ch4 CO	▶Range1 0-100 ppm	▶ 0.0	
	▶Range2 0-2000 ppm		
Ch5 O ₂	▶Range1 0-10 vol%	▶ 21.00	
	▶Range2 0-25 vol%		

A single cursor will appear.





• When setting all components to “at once”:

ZERO Cal.	ENT : Go on Calibration of selected Ch		ESC : Not calibration
Ch1 NO _x	▶Range1 0-100 ppm	▶ 0.0	
	▶Range2 0-2000 ppm		
Ch2 SO ₂	▶Range1 0-100 ppm	▶ 0.3	
	▶Range2 0-2000 ppm		
Ch3 CO ₂	▶Range1 0-10 vol%	▶ 0.00	
	▶Range2 0-20 vol%		
Ch4 CO	▶Range1 0-100 ppm	▶ -0.1	
	▶Range2 0-2000 ppm		
Ch5 O ₂	▶Range1 0-10 vol%	▶ 21.00	
	▶Range2 0-25 vol%		

Cursors will appear at all components where “at once” is set.



6.2.3 Setting of calibration range

This mode is used to set if the range of each Ch (component) at the zero or span calibration (manual calibration or auto calibration) should be calibrated with a single range or 2 ranges.

- (1) During measurement, press the  key to display the User mode.
- (2) Point the cursor to “Calibration Parameters” by pressing the  or  key. Press the  key.



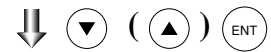

User Mode	Select an item with UP/DOWN and ENT Back with ESC
Switch Ranges <input checked="" type="checkbox"/> Calibration Parameters Alarm Setting Setting of Auto Calibration Setting of Auto Zero Calibration Setting of Peak Alarm Parameter Setting	

- (3) In the “Calibration Parameters” screen that appears, point the cursor to “About Calibration Range” by pressing the  or  key. Press the  key.



Cal. Parameters	Select an item with UP/DOWN and ENT Back with ESC
Calibration Valve About ZERO Calibration <input checked="" type="checkbox"/> About Calibration Range Auto Calibration Components / Range	

- (4) In the “Calibration Range Ch Selection” screen that appears, point the cursor to the Ch you want to set by pressing the  or  key. Press the  key.

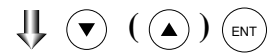

Cal. Settings	Select Ch No.		
Cal. Range			
<input checked="" type="checkbox"/> Ch1 NO _x	Range1 0-100 ppm Range2 0-2000 ppm		both
Ch2 SO ₂	Range1 0-100 ppm Range2 0-2000 ppm		current
Ch3 CO ₂	Range1 0-10 vol% Range2 0-20 vol%		current
Ch4 CO	Range1 0-100 ppm Range2 0-2000 ppm		both
Ch5 O ₂	Range1 0-10 vol% Range2 0-25 vol%		current

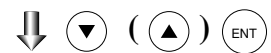

(5) On the “calibration range selection” screen that appears, select “both” or “current” by pressing the or the .

- If “both” is selected, zero or span calibration is performed with Range 1 and Range 2 of the selected Ch interlocked.
- If “current” is selected, zero or span calibration is performed only for the range displayed when calibration of selected Ch is performed.

Press the key after the selection, and the specified calibration is performed.

Cal. Settings		Set calibration range	
Cal. Range		current or both range	
Ch1 NOx	Range1 0-100 ppm Range2 0-2000 ppm	both	
Ch2 SO ₂	Range1 0-100 ppm Range2 0-2000 ppm	current	
Ch3 CO ₂	Range1 0-10 vol% Range2 0-20 vol%	current	
Ch4 CO	Range1 0-100 ppm Range2 0-2000 ppm	both	
Ch5 O ₂	Range1 0-10 vol% Range2 0-25 vol%	current	

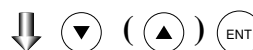

End of Manual Calibration Setting

To close “Setting of Calibration Range”

To close “Setting of Calibration Range” or to cancel this mode midway, press the

key. A previous screen will return.

Example

Ch1 NOx	Range 1: 0 to 100 ppm Range 2: 0 to 2000 ppm	both
Ch2 SO ₂	Range 1: 0 to 100 ppm Range 2: 0 to 2000 ppm	current

Ch1: Range 1 and Range 2 are calibrated together with zero and span calibration.

Ch2: Only currently displayed range is calibrated with zero and span calibration.

Note

To perform calibration for “both,” set the same calibration gas concentration for both ranges.

Manual Calibration screen

When setting NOx and CO to “both”

ZERO Cal.		ENT : Go on calibration of selected Ch		ESC : Not calibration	
Ch1 NOx	▶ Range1 0-100 ppm ▶ Range2 0-2000 ppm			-0.6	
Ch2 SO ₂	▶ Range1 0-100 ppm ▶ Range2 0-2000 ppm			0.4	
Ch3 CO ₂	▶ Range1 0-10 vol% ▶ Range2 0-20 vol%			0.00	
Ch4 CO	▶ Range1 0-100 ppm ▶ Range2 0-2000 ppm			-0.1	
Ch5 O ₂	▶ Range1 0-10 vol% ▶ Range2 0-25 vol%			21.00	

Two cursors will appear in both ranges (Ch1 and Ch4).

6.2.4 Setting of auto calibration component/range

Select the Ch (component) and the range with which auto calibration is to be performed.

The Ch for which “AR” has been selected as range switch mode is calibrated in the range set here even when auto calibration is performed.



- (1) During measurement, press the key to display the User mode.
- (2) Point the cursor to “Calibration Parameters” by pressing the or key. Press the key.

User Mode	Select an item with UP/DOWN and ENT Back with ESC
Switch Ranges <input checked="" type="checkbox"/> Calibration Parameters Alarm Setting Setting of Auto Calibration Setting of Auto Zero Calibration Setting of Peak Alarm Parameter Setting	

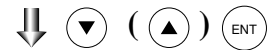

- (3) In the “Calibration Parameters” screen that appears, point the cursor to “Auto Calibration Components / Range” by pressing the or key. Press the key.

Cal. Parameters	Select an item with UP/DOWN and ENT Back with ESC
Calibration Valve About ZERO Calibration About Calibration Range <input checked="" type="checkbox"/> Auto Calibration Components / Range	



- (4) In the “Auto Calibration Components / Range” selection screen that appears, point the cursor to the Ch you want to set by pressing the or key. Press the key.

Cal. Settings Auto Cal.	Select Ch No.		
<input checked="" type="checkbox"/> Ch1 NO _x	▶Range1 0-100 ppm Range2 0-2000 ppm		enable
Ch2 SO ₂	▶Range1 0-100 ppm Range2 0-2000 ppm		enable
Ch3 CO ₂	▶Range1 0-10 vol% Range2 0-20 vol%		enable
Ch4 CO	▶Range1 0-100 ppm Range2 0-2000 ppm		enable
Ch5 O ₂	▶Range1 0-10 vol% ▶Range2 0-25 vol%		enable



- (5) The cursor next to the range of the selected Ch (component) is highlighted. Select the range to be calibrated mainly by pressing the \blacktriangle or the \blacktriangledown key.
- (6) Then press the ENT key, and calibration is performed in the selected range.

To close "Auto Calibration Component/range" setting

Auto calibration and the manual calibration of the component with which "AR" has been selected as range switch mode are performed in the range selected here. In this case, once the calibration is started, the range is automatically switched, and on completion of the calibration, the original range is resumed.

The range identification contact is interlocked with the range after the switch. However, if the hold setting is set to "ON," the contact status before calibration is maintained.

- (7) Press the \blacktriangleright key in the state described in (5), and the highlight is switched between "enable" and "disable" auto calibration.
- (8) Select "enable" of "disable" by pressing the \blacktriangle or the \blacktriangledown key.
- (9) Then press the ENT key.

To close the setting

Press the ESC key to exit automatic calibration component/range setting, and the previous screen appears.

Operation by setting

Auto calibration is performed under the following rules.

1. Zero calibration is performed at the same time, for the Ch (component) with which "enable" is selected at the time of auto calibration and auto zero calibration.
2. Span calibration is performed in the order from smallest Ch No., for the Ch (component) with which "enable" is selected at the time of auto calibration.

Note

ZERO calibration on auto calibration and auto zero calibration of the component with which "enable" is selected are performed in batch irrespective of the description in "6.2.2 Setting of manual zero calibration."

Cal. Settings Auto Cal.		Select a range for auto calibration		
Ch1 NO _x	\blacktriangleright Range1 0-100 ppm Range2 0-2000 ppm			enable
Ch2 SO ₂	\blacktriangleright Range1 0-100 ppm Range2 0-2000 ppm			enable
Ch3 CO ₂	\blacktriangleright Range1 0-10 vol% Range2 0-20 vol%			enable
Ch4 CO	\blacktriangleright Range1 0-100 ppm Range2 0-2000 ppm			enable
Ch5 O ₂	Range1 0-10 vol% \blacktriangleright Range2 0-25 vol%			enable

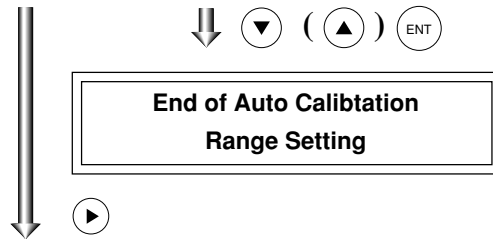

Cal. Settings Auto Cal.		Set enable or disable for auto calibration		
\blacktriangleright Ch1 NO _x	Range1 0-100 ppm Range2 0-2000 ppm			enable
Ch2 SO ₂	Range1 0-100 ppm Range2 0-2000 ppm			enable
Ch3 CO ₂	Range1 0-10 vol% Range2 0-20 vol%			enable
Ch4 CO	Range1 0-100 ppm Range2 0-2000 ppm			enable
Ch5 O ₂	Range1 0-10 vol% Range2 0-25 vol%			enable

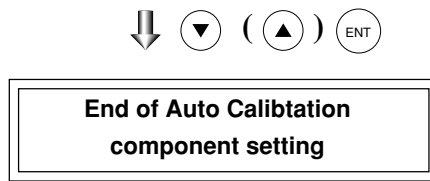





6.3 Alarm setting

6.3.1 Setting of alarm values



The High/Low limit alarm output setting for the measured concentration and power off alarm (alarm 6 only) setting can be made during measurement. Arbitrary 6 alarm contact outputs can be used.



To change alarm setting, set the alarm ON/OFF setting to OFF, and then change the value.

- (1) During measurement, press the  key to display the User mode.
- (2) Point the cursor to "Alarm Setting" by pressing the  or  key. Press the  key.



↓ 

User Mode	Select an item with UP/DOWN and ENT Back with ESC
Switch Ranges Calibration Parameters <input checked="" type="checkbox"/> Alarm Setting Setting of Auto Calibration Setting of Auto Zero Calibration Setting of Peak Alarm Parameter Setting	



- (3) After the alarm No. selection screen has appeared, point the cursor to the Alarm No. you want to set by pressing  or  key. Press the  key.

↓  () 



Alarm Setting	Select Alarm No. or Hysteresis setting
<input checked="" type="checkbox"/> Alarm-1 Alarm-2 Alarm-3 Alarm-4 Alarm-5 Alarm-6	
Hysteresis	00 %FS

- (4) After the alarm item selection screen has appeared, operate the  or  key until the cursor is aligned with a desired item and press the  key.

Note
 Set the values so that H-limit value > L-limit value and that (H-limit value – L-limit value) > hysteresis.

↓  () 

Alarm Setting Alarm-1	Select an item with UP/DOWN and ENT Back with ESC
<input checked="" type="checkbox"/> Channel Ch 1 H-Limit Range 1 100.0 ppm Range 2 2000 ppm L-Limit Range 1 000.0 ppm Range 2 0000 ppm Kind of Alarm High ON / OFF OFF	

↓  () 

(5) After setting, the alarm setting is now completed by pressing the **ENT** key.

To close the "Alarm Setting"

To close the "Alarm Setting" or to cancel this mode midway, press the **ESC** key. A previous screen will return.

Setting range

0% to 100% FS (Settable in each range).

Cursor for setting value

Alarm Setting Alarm-1	Select an item with UP/DOWN and ENT Back with ESC
Channel	Ch 1
H-Limit Range 1	100.0 ppm
Range 2	2000 ppm
L-Limit Range 1	000.0 ppm
Range 2	0000 ppm
Kind of Alarm	High
ON / OFF	OFF



End of Alarm Setting

Description of setting items

The alarm contact assigned the same number as the alarm is operated accordingly.

Channel: Channel setting targeted for issuance of alarm (Power off alarm can be selected for alarm 6.) One Ch No. can be selected for multiple alarms.

H-Limit value: Sets the high limit value (concentration) of alarm.

L-Limit value: Sets the low limit value (concentration) of alarm.

Kind of Alarm: Selects one of High limit alarm, Low limit alarm, and High limit or Low limit alarm, HH limit alarm, and LL limit alarm.

High, HH ... Alarm contact closes when above H-limit alarm.

Low, LL ... Alarm contact closes when below L-limit alarm.

High or Low ... Alarm contact closes when above H-limit value or below lower limit value.

If "Power" is selected for Channel, the contact is closed at all times while the power is on irrespective of the setting made here. (Alarm-6 only)

ON/OFF: Enables the alarm function if set at ON, or disables the alarm function if set at OFF.

* The H-limit value cannot be set below the L-limit value, and the L-limit value cannot be set above the H-limit value.

If it is desired to set the H-limit value below the L-limit value already stored in the memory, reduce the L-limit value beforehand, and vice versa.

Typical on-screen display when an alarm occurs

When an H-limit alarm occurs, the "H-alarm" message comes on in the field of relevant Ch (component). ("L-alarm" for L-limit alarm, "HH-alarm" for HH limit alarm, and "LL-alarm" for LL limit alarm)

1	H-alarm	ppm
2	SO ₂ (0-100)	0.0 ppm
3	CO ₂ (0-10)	0.003 vol%
4	CO (0-100)	0.0 ppm
5	O ₂ (0-25)	21.00 vol%

Note

For 10 minutes after turning on power, the alarm judgment is inactive.

6.3.2 Hysteresis setting

To prevent chattering of an alarm output near the alarm setting values, set the value of hysteresis.

- (1) In the “Alarm No. Selection” screen that appears, point the cursor to “Hysteresis” by pressing the \blacktriangle or \blacktriangledown key. Press the ENT key.

- (2) In the “Hysteresis Value Setting” screen that appears, enter hysteresis values.

For the value entry, 1-digit value is increased or decreased by pressing the \blacktriangle or \blacktriangledown key, and pressing the \blacktriangleright key moves the digit. After setting, press the ENT key.

To close "Hysteresis Setting"

To close the “Hysteresis Setting” or cancel the mode midway, press the ESC key. A previous screen will return.

Setting range

0 to 20% of full scale
[% full scale (FS)] represents the percentage with the width of the range of each component regarded as 100%.

Alarm Setting	Select Alarm No. or Hysteresis setting
Alarm-1 Alarm-2 Alarm-3 Alarm-4 Alarm-5 Alarm-6	
\blacktriangledown Hysteresis	00 %FS



Alarm Setting	Set Hysteresis 0 to 20%FS available
Alarm-1 Alarm-2 Alarm-3 Alarm-4 Alarm-5 Alarm-6	
Hysteresis	00 %FS

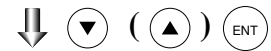

End of Hysteresis Setting

Note

The hysteresis is common to all alarms (components).

Hysteresis (In case of upper limit alarm)

An alarm output is turned ON if measurement value exceeds the upper limit value as shown below. Once the alarm output has been turned ON, it is not turned OFF as long as the indication does not fall below the hysteresis width from the upper limit value.

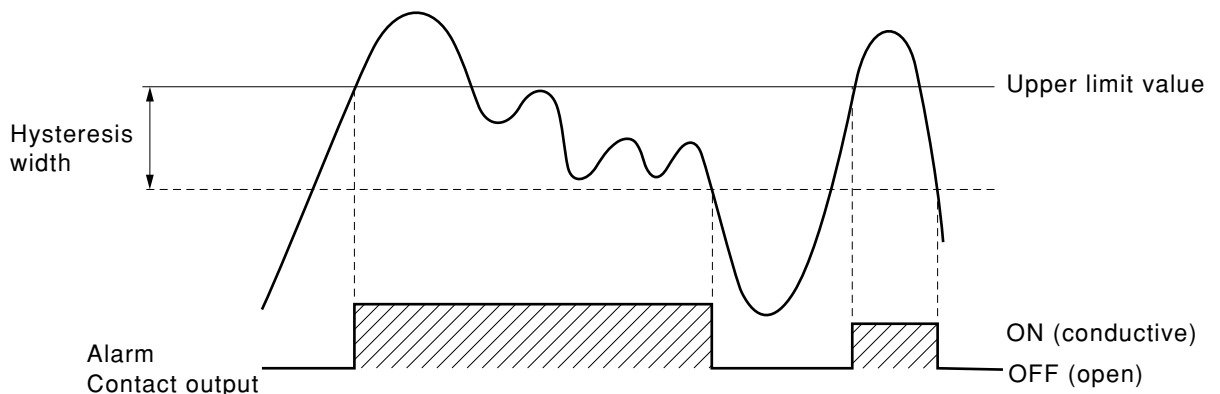

6.4 Setting of auto calibration

6.4.1 Auto calibration

Auto calibration is automatically carried out at the time when zero calibration and span calibration are set.

Before changing the setting of auto calibration, set the ON/OFF to OFF.

- (1) During measurement, press the **(MODE)** key to display the User mode.
- (2) Point the cursor to "Setting of Auto Calibration" by pressing the **(▲)** or **(▼)** key. Press the **(ENT)** key.

↓ (MODE)

User Mode	Select an item with UP/DOWN and ENT Back with ESC
Switch Ranges Calibration Parameters Alarm Setting <input checked="" type="checkbox"/> Setting of Auto Calibration Setting of Auto Zero Calibration Setting of Peak Alarm Parameter Setting	

- (3) In the "Setting of Auto Calibration" screen that appears, point the cursor to any item you want to set by pressing the **(▲)** or **(▼)** key. Press the **(ENT)** key.
- (4) In the "Auto Calibration Parameter Setting" screen that appears, perform the value entry or the setting. For the value entry or setting change, use the **(▲)** or **(▼)** key. To change the setting, use the **(▶)** key to move the cursor to the right.

↓ (▼) (▲) (ENT)

Set Auto Cal.	Select setting item
<input checked="" type="checkbox"/> Start Time SUN 12:00 Cycle 07 day Flow Time ON / OFF OFF Time : MON 12:34	
Auto Calibration Run	

After setting, press the **(ENT)** key, and auto calibration is carried out by the entered setting value.

Description of setting items

- Start Time : Setting at the first calibration (day of the week, hour, minute)
- Cycle : A period between the start time of one calibration and another (unit : hour/day)
- Flow Time : The time required for replacement by calibration gas
Time required for replacement of sample gas after the calibration is completed (Set by calibration gas. See the next page.)
- ON/OFF : ON/OFF of auto calibration

↓ (▼) (▲) (ENT)

Set Auto Cal.	Set Start Time
Start Time SUN 12:00 Cycle 07 day Flow Time ON / OFF OFF Time : MON 12:34	
Auto Calibration Run	

To close "Setting of Auto calibration"

To close the "Setting of Auto calibration" or cancel this mode midway, press the **(ESC)** key. A previous screen will return.

↓ (▼) (▲) (▶) (ENT)

End of Auto Calibration Setting
--

<Gas flow time> setting

- Press the **(ENT)** key in a state where the cursor is placed next to "Flow Time," and the flow time setting screen shown at right appears.

Set Auto Cal.	Select setting item
Start Time	SUN 12:00
Cycle	07 day
▣ Flow Time	ON / OFF
	OFF
Time : MON 12:34	
Auto Calibration Run	



- On the flow time setting screen that appears, move the cursor to the gas you want to change the setting by pressing the **(▲)** or the **(▼)** key, and then press the **(ENT)** key.

Set Auto Cal.	Select a Flow time
▣ Zero	350 sec.
Ch1 Span	350 sec.
Ch2 Span	350 sec.
Ch3 Span	350 sec.
Ch4 Span	300 sec.
Ch5 Span	300 sec.
Ex. time	300 sec.



- The highlighted value can be changed. Change the value by pressing the **(▲)** or the **(▼)** key, and then move the cursor to the right by pressing the **(▶)** key.
- After changing the value, press the **(ENT)** key.
- Press the **(ESC)** key to return to the automatic calibration setting screen.

Set Auto Cal.	Set flow time of calibration gas
	60 to 900 sec
Zero	▣ 350 sec.
Ch1 Span	350 sec.
Ch2 Span	350 sec.
Ch3 Span	350 sec.
Ch4 Span	300 sec.
Ch5 Span	300 sec.
Ex. time	300 sec.



Note) Only the Chs used are displayed on this screen. The Ex. time is the output signal hold extension time after the completion of calibration. It is valid only when the hold setting is set to "ON." The Ex. time set here is also the hold extension time at the time of manual calibration.

Auto calibration status contact output is closed during auto calibration (including Ex. time), and is open in other cases.

Example

Start Time	SUN	12:00
Cycle	1	day
Flow Time	Zero	350 sec
	Ch1 Span	350 sec
	Ch1 Span	350 sec
	Ch1 Span	350 sec
	Ch1 Span	300 sec
	Ch1 Span	300 sec
	EX. time	300 sec
ON/OFF	ON	

In case where auto calibration is carried out at the above setting.

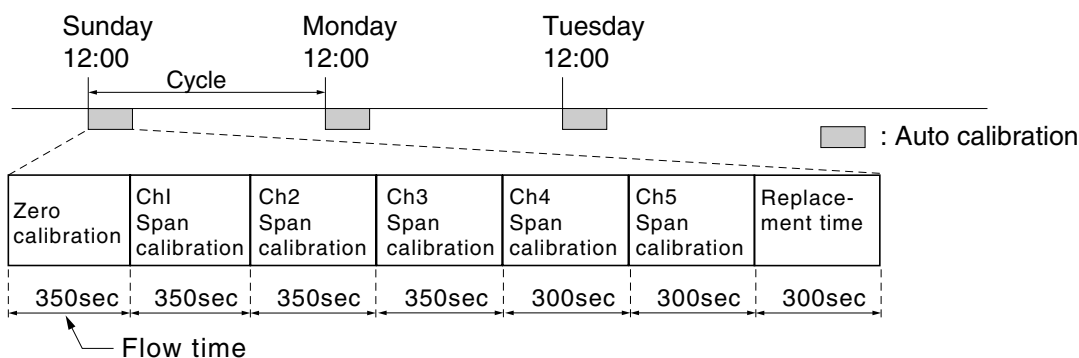

(An example of “Ch1: through Ch5: enable”, as given in Item 6.2.4 “Auto Calibration Components/range”)

Setting range

Cycle : 1 to 99 hours or 1 to 40 days (initial value 7days)
 Flow time : 60 to 900 sec (initial value 300sec)

Caution

- When an auto calibration starts, the measurement screen automatically appears.
- Any operation other than “Stop Auto Calibration” (see Item 6.4.2) is not permitted during auto calibration. “Stop Auto Calibration” cannot be performed with the key lock to ON. To cancel auto calibration forcibly, set the key lock to OFF and then execute “Stop Auto Calibration”.
- Turn on the power again after it is turned off (including the case of power failure) at the time set as the next start time in auto calibration, and then repeat it in the set cycle.

Remote start

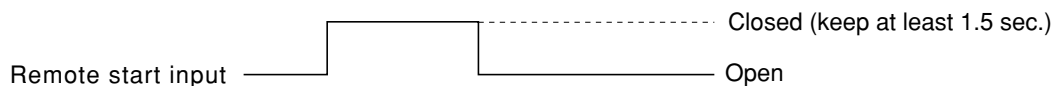

Whether the auto calibration is set at ON or OFF, an auto calibration is available by keeping the remote start input closed for at least 1.5 seconds.



6.4.2 Forced run/stop of auto calibration



Auto calibration can be performed just once or forcibly stopped while the calibration is performed.

6.4.2.1 Execution of auto calibration (only once)

- (1) Display the User mode screen. Move the cursor to “Setting of Auto Calibration” by pressing the  or the  key, and then press the  key.



User Mode	Select an item with UP/DOWN and ENT Back with ESC
Switch Ranges Calibration Parameters Alarm Setting <input checked="" type="checkbox"/> Setting of Auto Calibration Setting of Auto Zero Calibration Setting of Peak Alarm Parameter Setting	

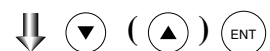

- (2) In the “Setting of Auto Calibration” item selection screen that appears, point the cursor to “Auto Calibration Run” by pressing the  or  key. Press the  key.

Set Auto Cal.	Select setting item
Start Time SUN 12:00 Cycle 07 day Flow Time ON / OFF OFF Time : MON 12:34	
<input checked="" type="checkbox"/> Auto Calibration Run	





- (3) “Run” is highlighted, displaying a message to confirm the execution of auto calibration. Press the  key to execute the auto calibration, and press the  key to cancel.

Set Auto Cal.	Auto Cal. Run ENT : Run / Stop ESC : Cancel
Start Time SUN 12:00 Cycle 07 day Flow Time ON / OFF OFF Time : MON 12:34	
Auto Calibration Run	



6.4.2.2 Forced stop of auto calibration

This mode is used to stop the auto calibration forcedly.

- (1) In the User mode that is displayed, point the cursor to “Setting of Auto Calibration” by pressing the  or  key. Press the  key.



User Mode	Select an item with UP/DOWN and ENT Back with ESC
Switch Ranges Calibration Parameters Alarm Setting <input checked="" type="checkbox"/> Setting of Auto Calibration Setting of Auto Zero Calibration Setting of Peak Alarm Parameter Setting	

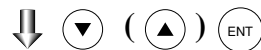

- (2) In the “Setting of Auto Calibration” item selection screen that appears, point the cursor to “Auto Calibration Stop” by pressing the  or  key. Press the  key.

Set Auto Cal.	Select setting item
Start Time SUN 12:00 Cycle 07 day Flow Time 300 sec ON / OFF OFF Time : MON 12:34	
<input checked="" type="checkbox"/> Auto Calibration Stop	



- (3) “Stop” is highlighted, displaying a message to confirm the stop of auto calibration. Press the  key to stop the auto calibration, and press the  key to cancel (not stopped).

Set Auto Cal.	Auto Cal. Stop ENT : Run / Stop ESC : Cancel
Start Time SUN 12:00 Cycle 07 day Flow Time 300 sec ON / OFF OFF Time : MON 12:34	
Auto Calibration Stop	

“Auto Calibration” screen

Example

In case where setting the auto calibration components (see Item 6.2.4) to “Ch1: enable” and “Ch2: enable”

• Zero calibration

A message, “Zero cal.” blinks at Ch1 and Ch2.

Ch 1	ZERO cal.	0.5 ppm
Ch 2	ZERO cal.	0.3 ppm
Ch 3	CO ₂ 0-10	0.000 vol%
Ch 4	CO 0-100	0.0 ppm
Ch 5	O ₂ 0-25	21.02 vol%

• Ch1 span calibration

A message, “Span cal.” blinks at Ch1.

Ch 1	SPAN cal.	90.8 ppm
Ch 2	SO ₂ 0-100	0.0 ppm
Ch 3	CO ₂ 0-10	0.00 vol%
Ch 4	CO 0-100	0.0 ppm
Ch 5	O ₂ 0-25	0.00 vol%

• Ch2 span calibration

A message, “Span cal.” blinks at Ch2.

Ch 1	NO _x 0-100	0.0 ppm
Ch 2	SPAN cal.	95.0 ppm
Ch 3	CO ₂ 0-10	0.00 vol%
Ch 4	CO 0-100	0.0 ppm
Ch 5	O ₂ 0-25	0.00 vol%

Caution

During auto calibration, any key operation is not permitted other than operations such as key lock ON/OFF and “Stop Auto Calibration.”

When the key lock is set at ON, even the “Auto Calibration Stop” cannot be used.

To stop “Auto Calibration” forcibly, set the key lock to OFF and then execute “Auto Calibration Stop.”

6.5 Setting of auto zero calibration

6.5.1 Auto zero calibration

Auto zero calibration is automatically carried out at the time when zero calibration is set. Components for which a calibration is to be made are determined by setting of auto calibration component in Item 6.2.4.

Before changing the setting of auto zero calibration, set the ON/OFF to OFF.

- (1) During measurement, press the **(MODE)** key to display the User mode.
- (2) Point the cursor to “Setting of Auto Zero Calibration” by pressing the **(▲)** or **(▼)** key. Press the **(ENT)** key.
- (3) In the “Setting of Auto Zero Calibration” screen that appears, point the cursor to any item you want to set by pressing the **(▲)** or **(▼)** key. Press the **(ENT)** key.
- (4) In the “Auto Zero Calibration Parameter Setting” screen that appears, perform the value entry or the setting. For the value entry or setting change, use the **(▲)** or **(▼)** key. To change the setting, use the **(▶)** key to move the cursor to the right.

After setting, press the **(ENT)** key, and auto zero calibration is carried out by the entered setting value.

Description of setting items

- Start Time : Setting at the first calibration (day of the week, hour, minute)
- Cycle : A period between the start time of one calibration and another (unit : hour/day)
- Flow Time : The time required for the calibration gas to be replaced in the cell
- ON/OFF : ON/OFF of auto zero calibration

To close "setting of Auto Zero Calibration"

To close the “Setting of Auto Zero Calibration” or cancel this mode midway, press the **(ESC)** key. A previous screen will return.

↓ (MODE)

User Mode	Select an item with UP/DOWN and ENT Back with ESC
Switch Ranges Calibration Parameters Alarm Setting Setting of Auto Calibration <input checked="" type="checkbox"/> Setting of Auto Zero Calibration Setting of Peak Alarm Parameter Setting	

↓ (▼) (▲) (ENT)

Set Auto Zero Cal.	Select setting item
<input checked="" type="checkbox"/> Start Time SUN 12:00 Cycle 07 day Flow Time 300 sec. ON / OFF OFF Time : MON 12:34	
Auto Zero Calibration Run	

↓ (▼) (▲) (ENT)

Set Auto Zero Cal.	Set Start Time
<input checked="" type="checkbox"/> Start Time SUN 12:00 Cycle 07 day Flow Time 300 sec. ON / OFF OFF Time : MON 12:34	
Auto Zero Calibration Run	

Press the **(◂)** or the **(◃)** key, and date and time are displayed alternately.

↓ (▼) (▲) (▶) (ENT)

End of Auto Zero Calibration Setting

Auto calibration status contact output is closed during auto zero calibration, and is open in other cases.

Example

Start time	SUN	12:00
Cycle	12	hour
Flow time	300	sec
ON/OFF	ON	

In case where auto zero calibration is carried out at the above setting.

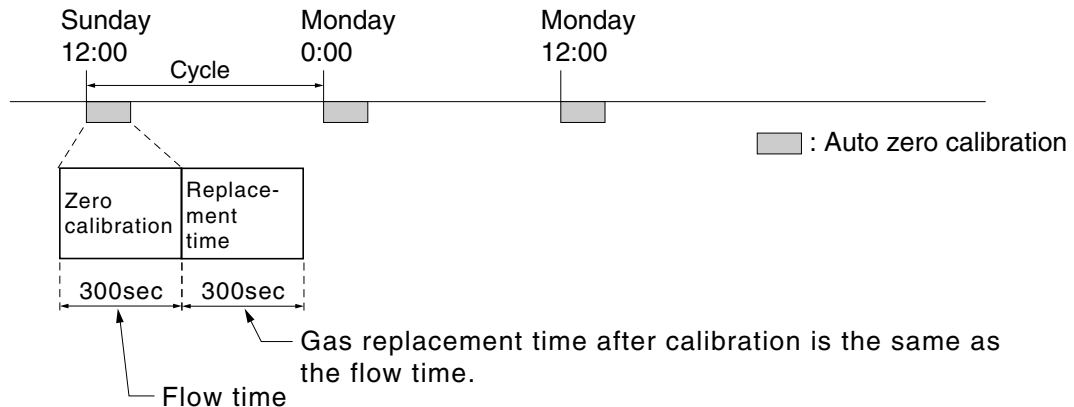

(An example of “Ch1: through Ch5: enable,” as given in Item 6.2.4 “Auto Calibration Components/range”)

Setting range

Cycle : 1 to 99 hours or 1 to 40 days (initial value 7days)
 Flow time : 60 to 900 sec (initial value 300sec)



Caution

- When an auto zero calibration starts, the measurement screen automatically appears.
- Any operation other than "Stop Auto Zero Calibration" (see Item 6.5.2) is not permitted during auto zero calibration. "Stop Auto Zero Calibration" cannot be performed with the key lock to ON. To cancel auto zero calibration forcedly, set the key lock to OFF and then execute "Stop Auto Zero Calibration."
- If the auto calibration period and auto zero calibration period have overlapped, the auto calibration is retained, ignoring the auto zero calibration of that period.
- When the hold setting is set to ON, the hold time of auto calibration contact and measurement value output signal is extended after calibration for gas replacement time.
- Turn on the power again after it is turned off (including the case of power failure) at the time set as the next start time in auto zero calibration, and then repeat it in the set cycle.

6.5.2 Forced run/stop of auto zero calibration



Auto zero calibration can be performed just once, or auto zero calibration can be forcibly stopped during calibration.

6.5.2.1 Execution of auto zero calibration (just once)

- (1) Move the cursor to “Setting of Auto Zero Calibration” by pressing the  or the  key on the user mode screen, and then press the  key.



User Mode	Select an item with UP/DOWN and ENT Back with ESC
Switch Ranges Calibration Parameters Alarm Setting Setting of Auto Calibration <input checked="" type="checkbox"/> Setting of Auto Zero Calibration Setting of Peak Alarm Parameter Setting	



- (2) In the “Setting of Auto Zero Calibration” item selection screen that appears, point the cursor to “Auto Zero Calibration Run” by pressing the  or  key. Press the  key.

Set Auto Zero Cal.	Select setting item
Start Time SUN 12:00 Cycle 07 day Flow Time 300 sec. ON / OFF OFF Time : MON 12:34	
<input checked="" type="checkbox"/> Auto Zero Calibration Run	





- (3) “Run” is highlighted, displaying a message to confirm execution of auto zero calibration. Press the  key to execute the calibration, and press the  key to cancel.

Set Auto Zero Cal.	Auto zero Run ENT : Run / Stop ESC : Cancel
Start Time SUN 12:00 Cycle 07 day Flow Time 300 sec. ON / OFF OFF Time : MON 12:34	
Auto Zero Calibration Run	



6.5.2.2 Forced stop of auto zero calibration

This mode is used to cancel the auto zero calibration forcibly.

- (1) In the User mode that is displayed, point the cursor to “Setting of Auto Zero Calibration” by pressing the  or  key. Press the  key.



User Mode	Select an item with UP/DOWN and ENT Back with ESC
Switch Ranges Calibration Parameters Alarm Setting Setting of Auto Calibration <input checked="" type="checkbox"/> Setting of Auto Zero Calibration Setting of Peak Alarm Parameter Setting	



- (2) In the “Setting of Auto Zero Calibration” item selection screen that appears, point the cursor to “Auto Zero Calibration Stop” by pressing the  or  key. Press the  key. (“Auto Zero Calibration Stop” appears when the screen is selected while auto zero calibration is performed.)

Set Auto Zero Cal.	Select setting item
Start Time SUN 12:00 Cycle 07 day Flow Time 300 sec. ON/OFF OFF Time : THU 10:56	
<input checked="" type="checkbox"/> Auto Zero Calibration Stop	



- (3) “Stop” is inverted. A message appears, prompting you to verify that you want to stop auto zero calibration. Press the  key to stop the auto zero calibration and the  key to cancel (not stopped).

Set Auto Zero Cal.	Auto Zero Stop ENT : Run / Stop ESC : Cancel
Start Time SUN 12:00 Cycle 07 day Flow Time 300 sec. ON/OFF OFF Time : THU 10:56	
Auto Zero Calibration Stop	

“Auto Zero Calibration” screen

Example

In case where setting the auto calibration components (see Item 6.2.4) to “Ch1: enable” and “Ch2: enable”

• Zero calibration

A message, “Zero cal.” blinks at Ch1 and Ch2.

Ch1	ZERO cal.	0.5 ppm
Ch2	ZERO cal.	0.3 ppm
Ch3	CO ₂ (0-10)	0.00 vol%
Ch4	CO (0-100)	0.0 ppm
Ch5	O ₂ (0-25)	21.02 vol%

Caution

During auto zero calibration, any key operation is not permitted other than operations such as key lock ON/OFF and “Stop Auto Zero Calibration.”







When the key lock is set at ON, even the “Stop Auto Zero Calibration” cannot be used.

To stop “auto zero calibration” forcedly, set the key lock to OFF and then execute “Auto Zero Calibration Stop.”

6.6 Peak alarm setting

When the peak number of times CO concentration exceeds the upper limit value during measurement exceeds the set number, an alarm is provided.



The peak alarm and this setting screen appear only when an option is added.

- (1) Press the  key in the Measurement mode, and the User mode appears.
- (2) Point the cursor to “Setting of Peak Alarm” by pressing the  or  key. Press the  key.
- (3) In the “Peak Alarm Setting” item selection screen that appears, point the cursor to any item you want to set by pressing the  or  key. Press the  key.



↓ 

User Mode	Select an item with UP/DOWN and ENT Back with ESC
Switch Ranges Calibration Parameters Alarm Setting Setting of Auto Calibration Setting of Auto Zero Calibration <input checked="" type="checkbox"/> Setting of Peak Alarm Parameter Setting	



- (4) Then, enter numeric values and perform the setting.

↓  () 

Peak Alarm	Select setting item
<input checked="" type="checkbox"/> Peak Alarm OFF Alarm Value 0500 ppm Alarm Count 05 times Hysteresis 00 %FS	

Entering the numeric values or setting the items should be carried out by using the  or  key.



After setting, press the  key, and the set values are saved.

↓  () 

Peak Alarm	Set Peak Alarm ON or OFF
Peak Alarm OFF Alarm Value 0500 ppm Alarm Count 05 times Hysteresis 00 %FS	

Description of setting items

- Peak Alarm : ON/OFF of peak alarm
- Alarm Value : If measuring value exceeds the set alarm value, a peak counter counts 1 time.
- Alarm Count : When a peak in excess of the setting time occurs, a peak count alarm output is provided.
- Hysteresis : To prevent possible chattering when the measuring value may exceed the set peak concentration by only 1 time, the peak count has an allowance in the hysteresis width.

↓   



End of Peak Alarm Setting

Setting range

- Alarm value : 10 to 1000 ppm → 5 ppm step (initial value: 500 ppm)
 - Alarm count : 1 to 99 times → (initial value: 5 times)
 - Hysteresis : 0 to 20 % of full scale → (initial value: 0% of full scale)
- [% full scale] represents the percentage with the CO range regarded as 100%.

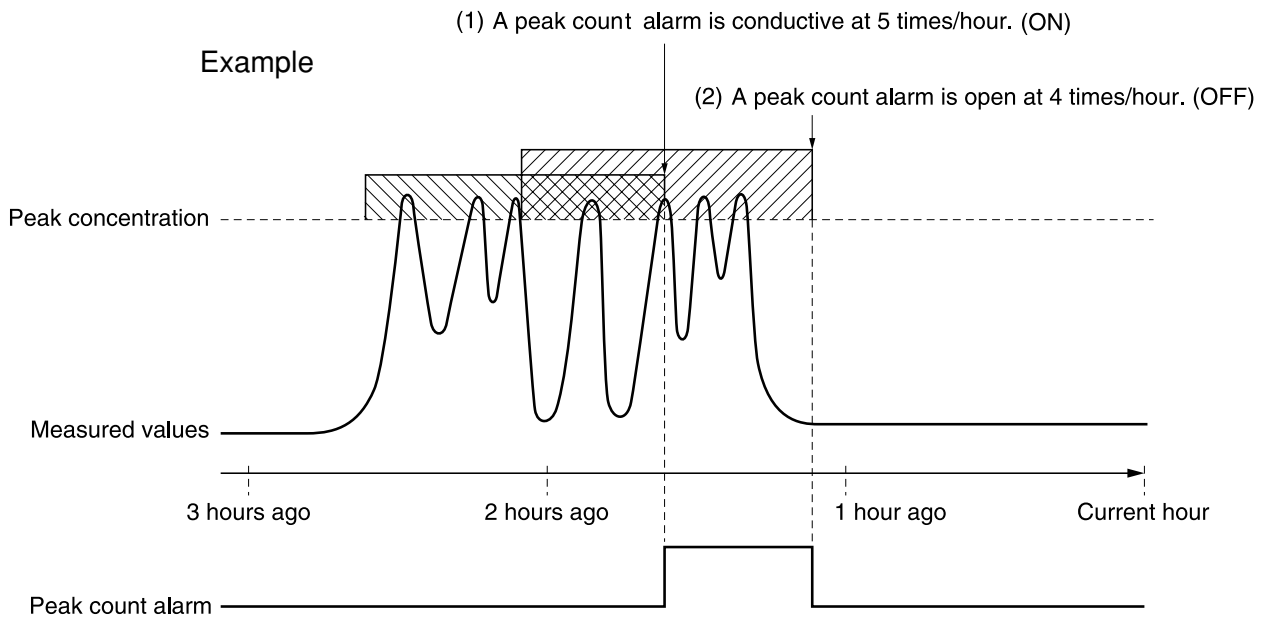
Action of peak alarm



If CO concentration exceeds the alarm value, counting will begin. If the number of peaks is over the set times per hour, a peak alarm contact output becomes closed (ON). If it is less than the set times per hour, it is open (OFF). Since 5 times of peaks /hour is marked at (1)  section from the above graph, the peak count alarm is turned ON. Since peaks of more than 5 times per 1 hour occur at the interval between (1) and (2) , the peak count alarm remains ON. Since at (2), peaks are reduced to 4 times per hour, it is turned OFF.

Like the hysteresis of the alarm setting, the hysteresis prevents possible chattering when measured gas is fluctuated near the alarm value.

* For 10 minutes after the power is turned ON, a peak alarm counting is not carried out.

Releasing peak count alarm

To release the peak count alarm, set the peak alarm to OFF.

Turning on the peak alarm initiates counting from 0.





6.7 Parameter setting

It allows you to carry out the parameter setting such as time, key lock, etc., as required. Items to be set are as follows:

Description of setting items



- Current Time : Current year, month, date, day of the week, hour, and minute setting
(The display appears in this order.)
Note: The clock backup time is 2 days. If power is turned on after it is kept off for 2 days or longer, make the time setting again.
- Key Lock : Sets with ON/OFF so that any key operation except the key lock OFF cannot be performed.
- Output Hold : Sets whether Calibration Output is held or not, and the holding value setting.
- Reset Av. Output : Resets the average value.
- Response time : Sets the response time of electrical system.
- Average Period : Sets the moving average time.
- Backlight Timer : Sets automatic OFF of the backlight of display unit and the time until backlight out.
- Maintenance mode : Enters passwords to switch to the Maintenance mode.



* For the maintenance mode, see Item 6.8.

- (1) To display the User mode, press the  key in the measurement mode.
- (2) Point the cursor to "Parameter Setting" by pressing the  or  key. Press the  key.



↓ 

User Mode	Select an item with UP/DOWN and ENT Back with ESC
Switch Ranges Calibration Parameters Alarm Setting Setting of Auto Calibration Setting of Auto Zero Calibration Setting of Peak Alarm  Parameter Setting	

- (3) In the "Parameter Setting" screen that appears, point the cursor to any item you want to set by pressing the  or  key. Press the  key.

↓  () 

Parameter	Select setting item
 Current Time	05/01/27 THU 13:50
Key Lock	OFF
Output Hold	OFF Current
Reset Av. Output	Reset
Response Time	
Average Period	
Backlight Timer	ON 5 min
To Maintenance Mode	0000

↓  () 

(4) In the Parameter Setting screen that appears, enter the numeric values and set the items. Entering the numeric values or setting the items should be carried out by using the \blacktriangle or \blacktriangledown key. To move the cursor to the right, press the \blacktriangleright key. After setting, press the ENT key, that the parameter setting is carried out with the value you set.

Parameter	Set day of week
Current Time	05/01/27 THU 13:50
Key Lock	OFF
Output Hold	OFF Current
Reset Av. Output	Reset
Response Time	
Average Period	
Backlight Timer	ON 5 min
To Maintenance Mode	0000

To close Parameter Setting screen

To close the "Parameter Setting" screen or cancel this mode midway, press the

ESC key.

A previous screen will return.



End of Parameter Setting

Setting Range

- Hold setting : 0 to 100% FS
- Response time : 1 to 60sec. (Initial value: 15 sec)
- Average period : 1 to 59 min or 1 to 4 hours (Initial value: 1 hour)
When setting the unit of 1 to 59 minutes is terms of minute or 1 to 4 hours with hour
- Backlight Timer : 1 to 60 min (Initial value: OFF)
- Maintenance mode : 0000 to 9999 (Initial value: 0000)

Output Hold

By setting an output hold to ON, an output signal of each channel are held during the calibration (manual calibration and auto calibration) and for the gas flow time (refer to Item 6.4, Setting of Auto Calibration). Regardless of Hold ON/OFF setting, an output signal can be held via an external input.

(1) Manual calibration

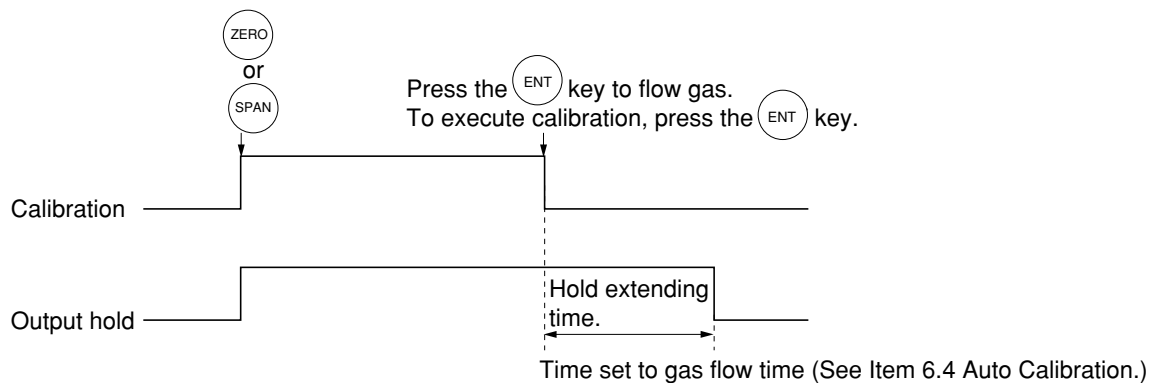

(2) Auto calibration

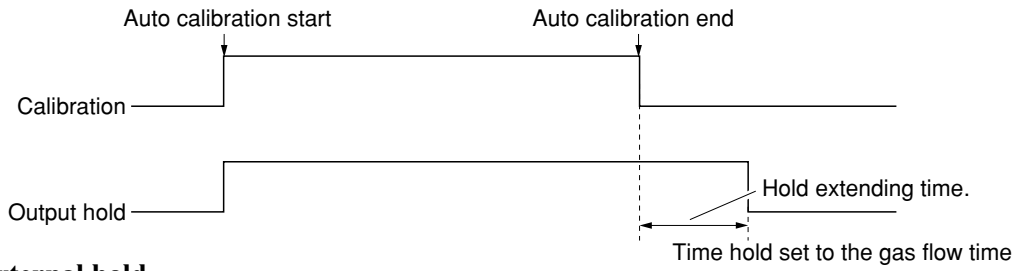

(3) External hold

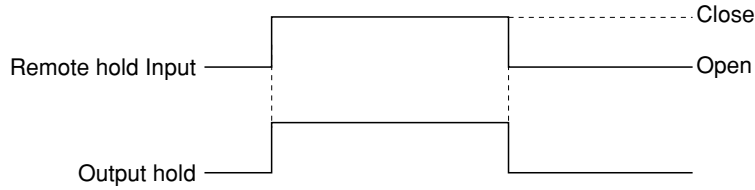

(4) Screen display during Holding

The “on Hold” message blinks on the measuring screen.

Since the screen displays the process of calibration is displayed during the manual calibration, “on Hold” is not displayed even if the output signal is held, but the screen is displayed with the hold extending time.

- (5)** If calibration is cancelled after the calibration gas is supplied regardless of during manual calibration or auto calibration, the holding extending time will be performed.



- (6) You can select the value for hold from the value immediately before entering output hold, “current,” and arbitrary value, “setting.”

Follow the procedures shown below to make the setting.

- 1) Press the  key in a state where the cursor is placed next to Hold.



Parameter	Select setting item
Current Time	05/01/27 THU 13:50
Key Lock	OFF
 Output Hold	ON Current
Reset Av. Output	Reset
Response Time	
Average Period	
Display OFF	ON 5 min
To Maintenance Mode	0000



- 2) “ON” or “OFF” is highlighted. Press the  or the  key to select ON or OFF. Press the  key to return to (1).



Parameter	Select Hold ON or OFF
Current Time	05/01/27 THU 13:50
Key Lock	OFF
Output Hold	ON Current
Reset Av. Output	Reset
Response Time	
Average Period	
Display OFF	ON 5 min
To Maintenance Mode	0000



- 3) Press the  key in a state ON/OFF is highlighted, and “Current” or “Setting” is highlighted. Select “Current” or “Setting” by pressing the  or the  key.

Parameter	Select Hold setting
Current Time	05/01/27 THU 13:50
Key Lock	OFF
 Output Hold	ON Setting
Reset Av. Output	Reset
Response Time	
Average Period	
Display OFF	ON 5 min
To Maintenance Mode	0000



- 4) Press the  key while “Current” is selected to return to (1). Press the  key while “Setting” is selected to go to the setting entering screen.
 “Current”: Holds the value immediately before the hold.
 “Setting”: Holds the value arbitrarily set.

- 5) On the parameter hold screen that appears, move the cursor next to the Ch (component) you want to make the setting by pressing the \blacktriangle or the \blacktriangledown key, and then press the ENT key.

↓ ENT

Parameter Hold	Select Ch No.		
\blacktriangledown Ch1	NO _x	010	%FS
Ch2	SO ₂	020	%FS
Ch3	CO ₂	015	%FS
Ch4	CO	012	%FS
Ch5	O ₂	022	%FS

- 6) The value is highlighted, indicating that the value can be changed. Change the value by pressing the \blacktriangle or the \blacktriangledown key, and then move the cursor to the right by pressing the \blacktriangleright key.
- 7) After the value is changed, press the ENT key.

↓ ENT

Parameter Hold	Set Hold value		
	0 to 100%FS		
Ch1	NO _x	\blacksquare 010	%FS
Ch2	SO ₂	020	%FS
Ch3	CO ₂	015	%FS
Ch4	CO	012	%FS
Ch5	O ₂	022	%FS

Meaning of setting

The setting is expressed in % against the range for both ranges.

When 0 to 1000 ppm is selected as the range, for example, if 10% FS is selected as hold setting, the output equivalent to 100 ppm is output and held irrespective of the measurement value at that time.

- 8) Press the ESC key to return to the parameter setting screen.

↓ ENT

End of Hold Setting

↓ ESC

Parameter Setting screen

Description of setting

- Instantaneous value display of the measurement cannot be held. (Output only can be held.)
- If set value is selected for hold, instantaneous O₂ conversion value is calculated and held based on the set value.
- Range identification contact output cannot be switched even if the range is switched during the hold.

Average value reset

This mode is used to clear all average values O₂ conversion average and O₂ average, and restarts averaging. All average values are reset at a time. The indication value and output value is 0 ppm, vol% or so at the time of the reset input (Refer to the average period).

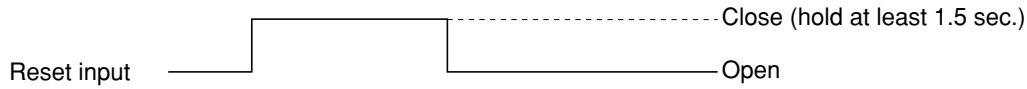

So long as close, resetting lasts.
At the edge of changing from closing to opening, the average action restarts.

Response time

The response time of the electrical system can be changed.

Setting is available by components.

Note) It does not provide exact seconds for the setting time, but it gives a guide of the setting time.

The setting value can be modified as requested by the customer.

Parameter	Select Ch No.		
Response Time			
<input checked="" type="checkbox"/> Ch1	NO _x	10	sec.
Ch2	SO ₂	20	sec.
Ch3	CO ₂	15	sec.
Ch4	CO	12	sec.
Ch5	O ₂	22	sec.

Average period

It allows you to set an average period of the average value of O₂ conversion and O₂ average.

It enables you to set an average time of 1 to 59 minutes (1-minute step) or 1 to 4 hours (1-hour step).

Changing the setting resets the average value of O₂ conversion and O₂ average value.

(Pressing the  validates the resetting only for components whose setting was changed.)

Parameter	Select Ch No.		
Average Period			
<input checked="" type="checkbox"/> Ch9	$\frac{\%}{\text{CU}}$ NO _x	01	hour
Ch10	$\frac{\%}{\text{CU}}$ SO ₂	01	hour
Ch11	$\frac{\%}{\text{CU}}$ CO ₂	01	hour
Ch12	$\frac{\%}{\text{CU}}$ O ₂	01	hour

Example of average action

In case the average period was set to 1 hour.

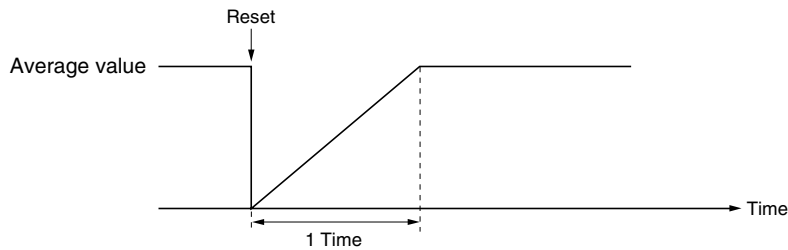

- Sampling occurs every 30 seconds.
- Every 30 seconds, the average for last 1 hour (time setting) is output.
- At the instant of resetting, zero is assumed for all past values. It means that the average value will not be correct for 1 hour after resetting.

Backlight Timer

Automatic OFF setting of the backlight of the LCD unit can be made.

When the specified time elapses from when the measurement screen is resumed, the backlight is automatically turned off. Press any key to reset backlight OFF.

Only when ON is selected, the time until auto OFF is displayed. Press the **▶** key in this state, and the time setting can be changed by pressing the **▲** or the **▼** key. Press the **ENT** key to confirm the selection.

If OFF is selected, the backlight is not turned off.



Parameter	Select ON or OFF
Current Time	05/01/27 THU 13:50
Key Lock	OFF
Output Hold	ON Previous value
Reset Av. Output	Reset
Response Time	
Average Period	
Backlight Timer	ON 5 min
To Maintenance Mode	0000

Maintenance mode

Enter the password and then press the **ENT** key to enter the maintenance mode. The password can be set by the password setting in maintenance mode. Default password setting at the time of delivery from the factory is "0000." You can enter the maintenance mode with the value before it is changed.

6.8 Maintenance mode

This mode is used for check of sensor input values, display of error log files or setting of passwords, etc. First, enter a password and then use it from the next operation. This mode is displayed by selecting the Maintenance Mode from “Item 6.7 Parameter Setting.”

- (1) Select the Maintenance mode from the Parameter Setting screen to display the Password Setting screen.
- (2) Enter the password, and the Maintenance Mode item selection screen will be displayed. Point the cursor to the item you want to set by pressing the  or  key and press the  key.
- (3) Next, each Maintenance screen is displayed.

Note) “To Factory Mode” is used for our service engineers only. Refrain from using this mode.

- (4) Press the  key to return to the Maintenance Mode item selection screen from each screen.

• Sensor Input Value screen

Description of Sensor Input Value screen

- NO_x M : NO_x sensor input value
- NO_x C : NO_x interference compensation sensor input value
- SO₂ M : SO₂ sensor input value
- SO₂ C : SO₂ interference compensation sensor input value
- CO₂ M : CO₂ sensor input value
- CO₂ C : CO₂ interference compensation sensor input value
- CO M : CO sensor input value
- CO C : CO interference compensation sensor input value
- Temperature: temperature sensor input value
- O₂ : O₂ sensor input value

• Error Log screen

Description of Error Log screen

Error history. Fourteen newest errors are logged. For error number, date and time (year, month, day, period) of occurrence, channel and other details of error, refer to Item 8.1 Error message. Select Clear Error Log and press the  key, and the error log is cleared completely.

Maintenance Mode	Select operating item
<input checked="" type="checkbox"/> 1. Sensor Input Value 2. Error Log 3. Cal. Log 4. Optical Adjustment 5. Interference Compensation Adj. 6. Output Adj. 7. Other Parameter 8. To Factory Mode	



Each “Maintenance” screen

Maintenance Sensor Input					
	sensor	input		sensor	input
	NO _x M	648		O ₂	20785
	C	499		TEMP	15785
	SO ₂ M	1518			
	C	425			
	CO ₂ M	1120			
	C	80			
	CO M	39			
	C	80			

Maintenance Mode Error Log	ENT : Clear Error Log ESC : Back					
Error No.	Y	M	D	H	M	Ch
No. 4	04	2	11	18	10	5
No. 1	04	1	10	12	2	1
No. 6	03	12	1	10	10	2
No. 9	03	12	1	10	10	2
No. 5	03	12	1	0	0	2
No. 9	03	12	1	0	0	2
Next page						Page 1
<input checked="" type="checkbox"/> Clear Error Log						

• **Calibration Log screen**

Description of Calibration Log screen

Past calibration history.
 Sensor input value, concentration value, and the date when zero/span calibration is performed are logged. The 10 newest calibration data is logged by each component.

Move the cursor to Clear Calibration Log and press the **(ENT)** key, and the calibration log is cleared completely.

- Z1 : Zero calibration (Z) of Range 1
- S1 : Span calibration (S) of Range 1
- M : Value of measuring detector at the time of calibration
- C : Value of the interference compensation detector at the time of calibration
- Con : Concentration value displayed before calibration

Maintenance Cal. Log	Select Ch No.
<input checked="" type="checkbox"/> Ch1 NOx	
Ch2 SO2	
Ch3 CO2	
Ch4 CO	
Ch5 O2	
Clear Error Log	



Maintenance Cal. Log	Select Ch No.				
Ch1 NOx					
R	M	C	Con	Y	D H M
Z1	00023	00045	-0.2	12	11 18 10
S1	05439	01254	189.5	12	11 18 10

Caution

If the following operation is maladjusted, the measurement may be adversely and excessively affected. Carry out the operation with utmost attention.

• **Optical adjustment screen**

For details of this item, refer to “Item 7.3.3 Optical zero adjustment method”.

Press **(ENT)** key and turn ON the solenoid valve signal for each calibration gas by using the **(▲)** or **(▼)** key.





Maintenance Optical Adj.	ENT : Selectable flow gas		
1-1	9	2-1	24
	3		1
1-2	21	2-2	40
	27		80
<input checked="" type="checkbox"/> GAS	Sample		



• **Moisture interference adjustment screen**

For details of this item, refer to “Item 7.3.4 Moisture interference adjustment method.”

Description of moisture interference adjustment screen

In values on the left side of screen, the moisture interference for each component is already offset. The figures at right are interference compensation coefficients.

Move the  cursor to a desired Ch (component) by pressing the  or the  key, and then press the  key, and the selected value at right is highlighted.

Check that the gas for moisture interference compensation is flowing, change the moisture interference compensation coefficient using the  or the  key, adjust the value at left so that it becomes near zero, and then press the  key to log moisture interference compensation value.

Caution

Since an interference compensation detector is not provided if the 1st range is beyond 0 to 10 vol%, no interference adjustment can be performed (no need).

Maintenance	Select Ch No. with UP / DOWN and ENT Back with ESC		
 Ch1	NOx	10	1.252
Ch2	SO ₂	-33	0.983
Ch3	CO ₂	13	0.000
Ch4	CO	20	1.922
ALL			
Valve OFF			









Maintenance	Adjust with UP / DOWN ENT : Memorized ESC : Back		
Ch1	NOx	0	1.26 
Ch2	SO ₂	-33	0.983
Ch3	CO ₂	13	0.000
Ch4	CO	20	1.922
ALL			
Valve OFF			

• **Output adjustment screen**

Description of output adjustment screen

Analog output adjustment screen.
Connect the digital multi meter to the output terminal corresponding to the number of OUT to be adjusted, and adjust the value so that 4mA or 0V is output at zero and 20mA or 1V is output at span.

Move the cursor using the , , or the  key to the output (OUT No. and zero/span) to be adjusted, and then press the  key.

The selected value is highlighted. Adjust the value, while watching the output, by pressing the  or the  key. Press the  key to select the next digit.

On completion of the adjustment, press the  key.

Maintenance Mode Output Adj.			Adjust OUTPUT ZERO and SPAN		
OUT	Zero	Span	OUT	Zero	Span
1	█1245	11845	7	01900	12500
2	01245	11845	8	01900	12500
3	01245	11845	9	01900	12500
4	01245	11845	10	01900	12500
5	01245	11845	11	01900	12500
6	01245	11845	12	01900	12500

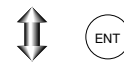

Maintenance Mode Output Adj.			Zero / Span adjustment		
OUT	Zero	Span	OUT	Zero	Span
1	0124█5	11845	7	01900	12500
2	01245	11845	8	01900	12500
3	01245	11845	9	01900	12500
4	01245	11845	10	01900	12500
5	01245	11845	11	01900	12500
6	01245	11845	12	01900	12500

• Other parameter

Description of each setting screen

Password Set : Set the password used to move from the parameter setting screen to the maintenance mode.

Arbitrary 4-digit number can be selected.

O2 ref. Value

: Set the oxygen concentration reference value at the time of oxygen conversion calculation. Settable in the range from 00 to 19%.

Limit



: Set the oxygen concentration limit at the time of oxygen conversion calculation. Settable in the range from 01 to 20%.

* Refer to the O2 conversion concentration value in “5.3 Outline of display screen” for oxygen conversion calculation procedure.



Station No. : Set the station No. for MODBUS communication. Settable in the range from 00 to 32.

Range setting : Moves to the screen on which measuring range is changed.

Maintenance Mode setting	Select an item
Password Set 2465 O2 ref. Value 12% O2 limit 20% O2 Station No. 01 Range setting	

Press the  or the  key to move the cursor to the item whose setting is to be changed.

The values for password, oxygen conversion, limit, and station No. are highlighted.

Press the  or the  key to change the value to desired one, and then press the  key.

Note: Pay attention not to forget the password. Otherwise you cannot enter the maintenance mode.

<How to set/change the range>

The measuring range can be arbitrarily selected in the minimum and the maximum range specified at the time of purchase. The range to be used can be selected 1 or 2.

- (1) Move the cursor to the item to be set by pressing the or the key, and then press the key.

- (2) Move the cursor to the Ch (component) whose setting is to be changed by pressing the or the key, and then press the key.

- (3) Move the cursor to the item whose setting is to be changed by pressing the or the key, and then press the key.

Settable range

The value for range 1 and range 2 must fall within the range from the MIN and the MAX range (including the MIN and the MAX range), and at the same time range 1 must be smaller than range 2.

The number of ranges is 1 or 2.

- (4) Press the or the key to change the value. Press the key to select the next digit. In a state where the decimal point is highlighted, press the or the key, and the decimal point position can be changed.

- (5) When necessary change is made, press the key.

Caution

Be sure to perform zero/span calibration before changing the range.

If calibration is not carried out, the measurement value may be defected.

Maintenance Mode setting	Select an item
Password set 2465 O2 ref. Value 12% O2 limit 20% O2 Station No. 01 <input checked="" type="checkbox"/> Range setting	



Maintenance Mode Range set	Select Ch No.
<input checked="" type="checkbox"/> Ch1 NOx Ch2 SO2 Ch3 CO2 Ch4 CO Ch5 O2	

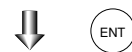

Maintenance Mode Range Set Ch1 NOx	Select range or range num.
MIN range 100.0 ppm Range 1 500.0 ppm Range 2 1000. ppm <input checked="" type="checkbox"/> MAX range 2000. ppm Range num. 2	

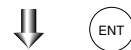





Maintenance Mode Range Set Ch1 NOx	Set range
MIN range 100.0 ppm Range 1 5 00.0 ppm Range 2 1000. ppm MAX range 2000. ppm Range num. 2	

6.9 Calibration

6.9.1 Zero calibration

It is used for zero point adjustment. For zero calibration gas, suited for an application should be used according to “(3) Standard gas in Item 3.3 Sampling.”

- Press the  key on the Measurement screen to display the Manual Zero Calibration screen.

- Select the Ch (component) to be calibrated by pressing the  or  key. After selection, press the  key, and zero gas will be supplied.

Caution

For the Ch (components) that is set to “both” in the “Zero Calibration” of the Calibration Setting mode, zero calibration is also carried out at the same time.





- Wait until the indication is stabilized with the zero gas supplied. After the indication has been stabilized, press the  key. Zero calibration in range selected by the cursor is carried out.

Note: For the Ch (component) for which “AR” is selected in “6.1.1 Setting range switch mode,” the cursor automatically moves to the range selected in “Setting of auto calibration component/range” (6.2.4), and calibration is carried out within that range.





To close “Zero Calibration”

To close the “Zero Calibration” or cancel this mode midway, press the  key. A previous screen will return.







ZERO Cal.		Select Ch No. with UP / DOWN and ENT Back with ESC	
 Ch1 NO _x	▶Range1 0-100 ppm ▶Range2 0-2000 ppm		0.0
 Ch2 SO ₂	▶Range1 0-100 ppm ▶Range2 0-2000 ppm		0.0
 Ch3 CO ₂	▶Range1 0-10 vol% ▶Range2 0-20 vol%		0.00
 Ch4 CO	▶Range1 0-100 ppm ▶Range2 0-2000 ppm		0.0
 Ch5 O ₂	▶Range1 0-10 vol% ▶Range2 0-25 vol%		20.09



ZERO Cal.		Select Ch No. with UP / DOWN and ENT Back with ESC	
 Ch1 NO _x	▶Range1 0-100 ppm ▶Range2 0-2000 ppm		0.0
 Ch2 SO ₂	▶Range1 0-100 ppm ▶Range2 0-2000 ppm		0.0
 Ch3 CO ₂	▶Range1 0-10 vol% ▶Range2 0-20 vol%		0.00
 Ch4 CO	▶Range1 0-100 ppm ▶Range2 0-2000 ppm		0.0
 Ch5 O ₂	▶Range1 0-10 vol% ▶Range2 0-25 vol%		20.09



ZERO Cal.		ENT : Go on calibration of selected Ch. ESC : Not calibration	
Ch1 NO _x	▶Range1 0-100 ppm ▶Range2 0-2000 ppm		0.0
Ch2 SO ₂	▶Range1 0-100 ppm ▶Range2 0-2000 ppm		0.9
Ch3 CO ₂	▶Range1 0-10 vol% ▶Range2 0-20 vol%		0.34
Ch4 CO	▶Range1 0-100 ppm ▶Range2 0-2000 ppm		1.1
Ch5 O ₂	▶Range1 0-10 vol% ▶Range2 0-25 vol%		20.09

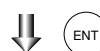

To Measurement screen after
executing Manual Zero Calibration



6.9.2 Span calibration

It is used to perform a span point adjustment. Supply calibration gas with concentration set to the span value to perform the span calibration. For the span calibration gas for the NO_x, SO₂, CO₂, CO measurement, use the standard gas with a concentration of 90% or more of the range value. For the span calibration gas for the O₂ measurement, use the standard gas with a concentration of 90% or more of the range value when measuring with the built-in O₂ sensor, and use the standard gas of about 2 vol% when measuring with an external zirconia O₂ sensor.

- (1) Press the  key on the Measurement screen to display the Manual Span Calibration screen.

↓ 

SPAN Cal.		Select Ch No. with UP / DOWN and ENT Back with ESC	
<input checked="" type="checkbox"/> Ch1 NO _x	▶ Range1 0-100 ppm Range2 0-2000 ppm		0.0
Ch2 SO ₂	▶ Range1 0-100 ppm Range2 0-2000 ppm		0.0
Ch3 CO ₂	▶ Range1 0-10 vol% Range2 0-20 vol%		0.00
Ch4 CO	▶ Range1 0-100 ppm Range2 0-2000 ppm		0.0
Ch5 O ₂	▶ Range1 0-10 vol% Range2 0-25 vol%		20.09

- (2) Select Ch (component) to be calibrated by pressing the  or  key and press the  key. The calibration gas is supplied.

Caution



When “both” from “Calibration Range” of the Calibration Setting mode is set, span calibration is performed together with 2 Ranges.

- (3) Wait until the indication is stabilized in the state where the calibration gas is supplied. After the indication has been stabilized, press the  key. Span calibration of Range selected by the cursor is performed.

Note: For the Ch (component) for which “AR” is selected in “6.1.1 Setting range switch mode,” the cursor automatically moves to the range selected in “Setting of auto calibration component/range” (6.2.4), and calibration is carried out within that range.

To close "Span Calibration"

To close the “Span Calibration” or cancel this mode midway, press the  key. A previous screen will return.

↓  () 

SPAN Cal.		Select Ch No. with UP / DOWN and ENT Back with ESC	
Ch1 NO _x	▶ Range1 0-100 ppm Range2 0-2000 ppm		0.0
<input checked="" type="checkbox"/> Ch2 SO ₂	▶ Range1 0-100 ppm Range2 0-2000 ppm		0.0
Ch3 CO ₂	▶ Range1 0-10 vol% Range2 0-20 vol%		0.00
Ch4 CO	▶ Range1 0-100 ppm Range2 0-2000 ppm		0.0
Ch5 O ₂	▶ Range1 0-10 vol% Range2 0-25 vol%		20.09

↓ 

SPAN Cal.		ENT : Go on calibration of selected Ch. ESC : Not calibration	
Ch1 NO _x	▶ Range1 0-100 ppm Range2 0-2000 ppm	<input checked="" type="checkbox"/>	0.0
Ch2 SO ₂	▶ Range1 0-100 ppm Range2 0-2000 ppm	<input checked="" type="checkbox"/>	0.9
Ch3 CO ₂	▶ Range1 0-10 vol% Range2 0-20 vol%	<input checked="" type="checkbox"/>	0.34
Ch4 CO	▶ Range1 0-100 ppm Range2 0-2000 ppm	<input checked="" type="checkbox"/>	1.1
Ch5 O ₂	▶ Range1 0-10 vol% Range2 0-25 vol%	<input checked="" type="checkbox"/>	20.09

↓ 

**To Measurement screen after
executing Manual Span Calibration**

7. MAINTENANCE

7.1 Daily check

(1) Zero calibration and span calibration

- (1) Perform zero calibration. For the calibration procedures, refer to “Item 6.9.1 Zero calibration.”
- (2) Then, perform span calibration. For the calibration procedures, refer to “Item 6.9.2 Span calibration.”
- (3) Zero calibration and span calibration should be carried out once a week, as required.

(2) Flow rate check

- (1) Sampling gas flow and purge gas flow are as follows:
 - Sampling gas flow: 0.5L/min±0.2L/min
 - Purge gas flow: About 1L/min
- (2) Check and maintenance should be carried out every day, as required.

7.2 Daily check and maintenance procedures

Table 7.1 Maintenance and check table

	Parts to be checked	Phenomena	Causes	Remedy
Daily check	Indication value	Indication values are lowered. Indication values are higherd.	(1) Dust is mixed in sampling cell.	(1) Clean the sampling cell. In addition, check sampling devices, especially gas filter.
			(2) Air is absorbed midway in the sampling pipe.	(2) Find out cause of leak and repair.
	Purge gas flow is included when purging gas in sampling gas flow rate.	Standard flow is beyond the specified flow rate of 0.5L/min, 0.3 to 0.7L/min.	_____	Adjust by needle valve of flow rater.
Weekly check	Zero point of gas analyzer	It is deflected.	_____	Adjust.
	Span point of gas analyzer	It is deflected.	_____	Adjust.
Yearly check	Gas analyzer	Regardless of any phenomena	_____	Overhaul.

7.3 Maintenance of analyzer unit

7.3.1 Cleaning method for sample cell (pipe cell)

This section is strictly factory adjusted. Handle it with utmost attention.

If it is absolutely required, contact us.

- (1) Turn off the power switch, stop the sample gas, and allow the zero gas to flow for several minutes to purge the cell interior.

Loosen the setscrew (2 pieces) from the top cover and remove it.

- (2) Remove the internal gas inlet tube.
- (3) Loosen both right and left screws for cell holding plate.

- Remove the sample cell only.

- (4) Turn to the left the sample cell window and remove it from the sample cell (see Fig. 7-1).

- (5) For cleaning the window and cell inside surface, first eliminate coarse dust by soft brush or the like and then wipe them by soft rag.

The window is easy to get scratched. Pay utmost attention so as not to damage it.

- (6) After the end of sample cell cleaning, mount the cell in place and proceed to running.

After cleaning sample cell, be sure to perform optical zero adjustment (see Item 7.3.3) and moisture interference compensation adjustment (see Item 7.3.4).

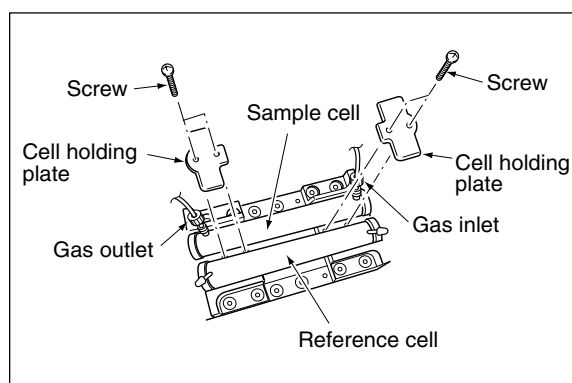
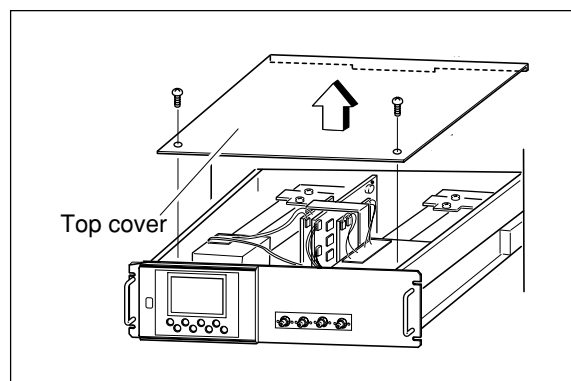

Caution

If the window or the cell interior is very dirty, use a soft cloth moistened with absolute alcohol. A slightly corroded infrared transmission window or sample cell can be remedied by gently rubbing with chromium oxide powder on cleaning cloth but an excessively corroded one must be replaced. When cleaning, do not exert an excessive stress.

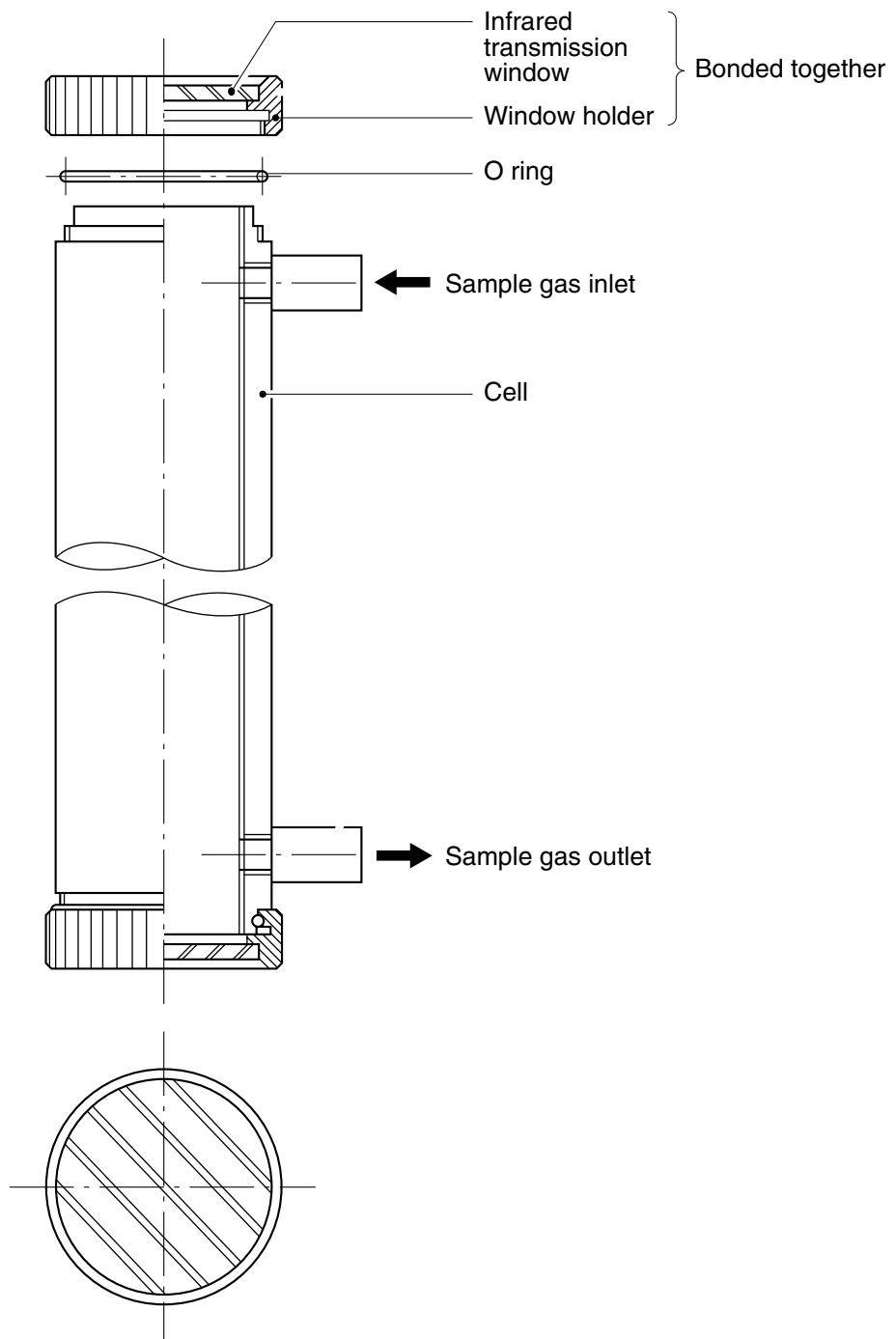

Fig. 7-1 Structure of sample cell (pipe cell)

7.3.2 Cleaning method for sample cell (block cell)

- (1) Turn off the power switch, stop the sample gas, and allow the zero gas to flow for several minutes to purge the cell interior.
Loosen the setscrew (2 pieces) from the top cover and remove it.

- (2) Remove the internal gas inlet tube.
- (3) Loosen the 2 detector set bolts.

Note) The distribution cell, block cell and detector are fastened by the same bolts.

- (4) Using the furnished cell mounting tool, turn the window fixture to the left and remove it from the cell.
(See the structure of sample cell (block cell) in Fig. 7-2.)

- (5) For cleaning the infrared transmission window and cell inside surface, first eliminate coarse dust by soft brush or the like and then wipe them by soft rag.
The window is easy to get scratched. Pay utmost attention so as not to damage it.

- (6) After the end of sample cell cleaning, mount the cell in place and proceed to running.

After cleaning sample cell, be sure to perform optical zero adjustment (see Item 7.3.3) and moisture interference compensation adjustment (see Item 7.3.4).

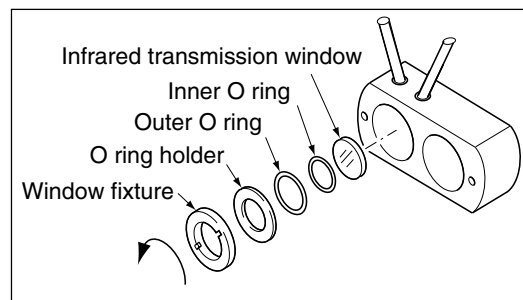
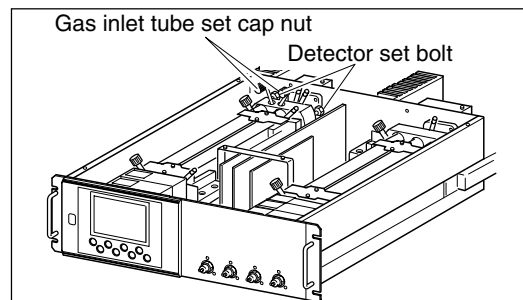
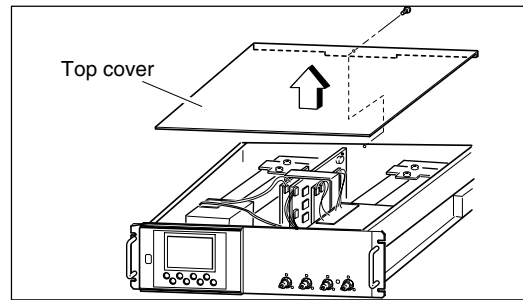

Caution

If the window or the cell interior is very dirty, use a soft cloth moistened with absolute alcohol. A slightly corroded infrared transmission window or sample cell can be remedied by gently rubbing with chromium oxide powder on cleaning cloth but an excessively corroded one must be replaced. When cleaning, do not exert an excessive stress.

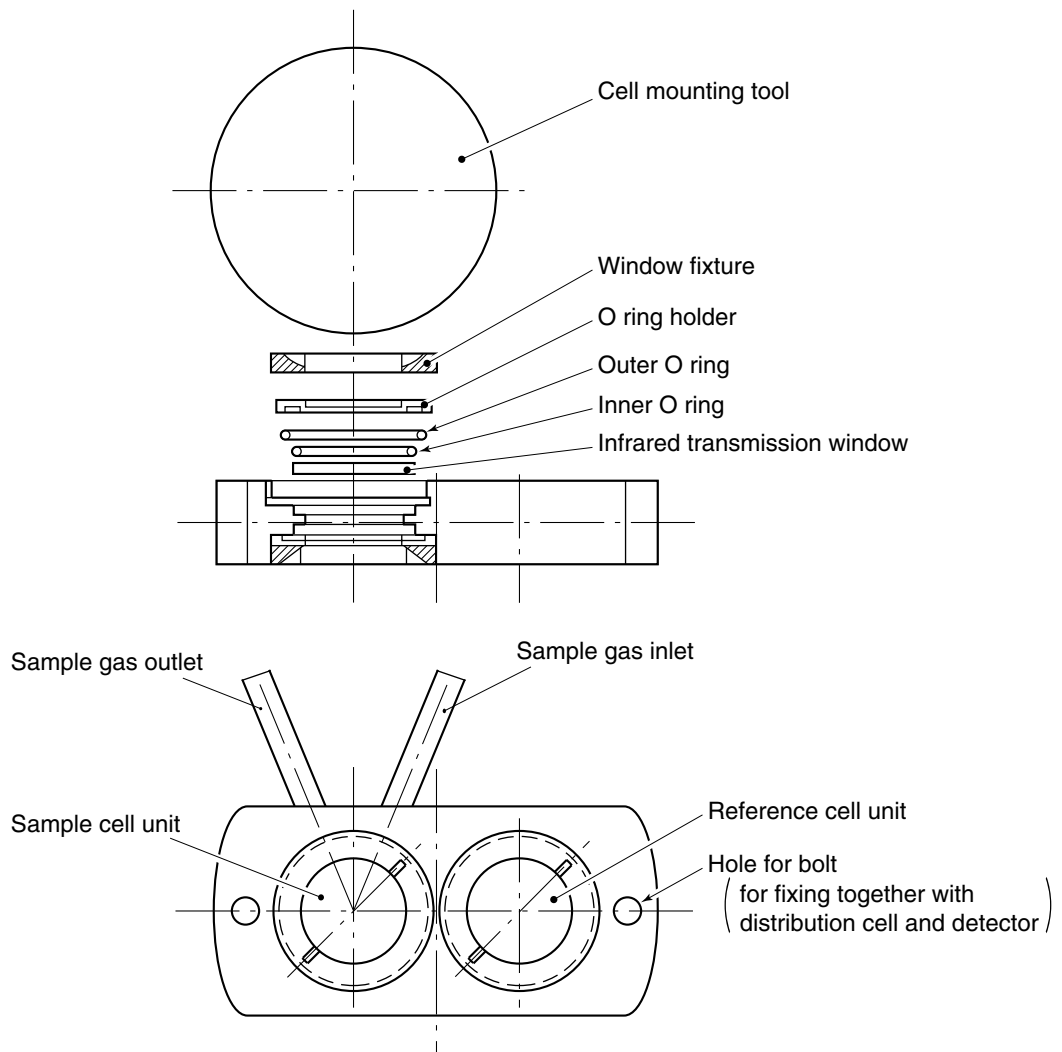

Structure of sample cell (of 32, 16, 8, 4, 2 mm long)
(sample cell and reference cell are integrated)

Note) Use the dedicated cell mounting tool (furnished).

Fig. 7-2 Structure of sample cell (block cell)

7.3.3 Optical zero adjustment method (optical balance adjustment)

Caution

If the following operation is maladjusted, the measurement may adversely be affected. If you are not trained for adjustment, do not carry out this operation but contact the distributor or our service-man.

The adjustment is performed at reassembly after removing the sample cell, etc. for cleaning, etc.

- (1) Remove the top cover. Allow dry N₂ or air to flow through the analyzer unit sample gas inlet until the reading stabilizes. The sample gas is introduced directly to the INLET of analyzer unit through the gas cylinder.
- (2) Proceed to an optical adjustment in the maintenance mode. The display on the operation panel of the main unit is as illustrated on the right. Balance adjustment is not required if the display falls within ± 100 .

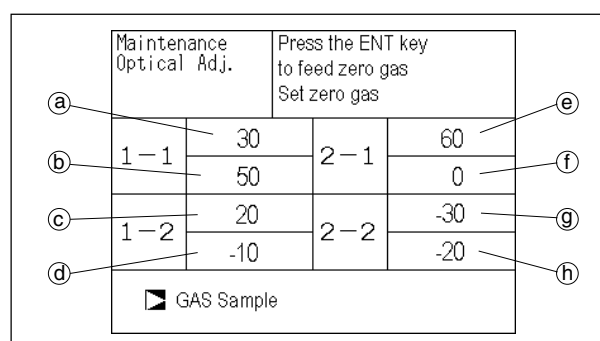
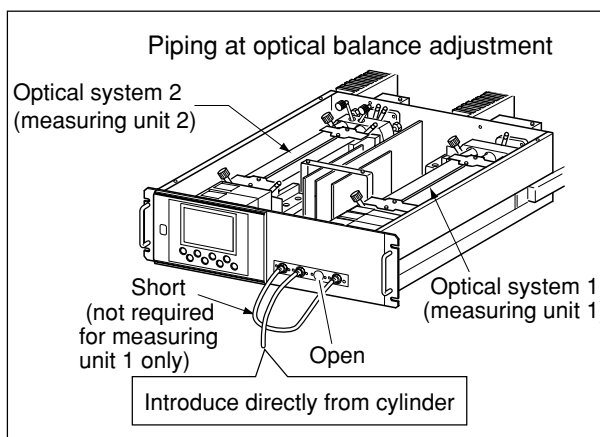

<Correspondence between measurement detector and indicated position>

No. of components to be measured	(a)	(b)	(c)	(d)	(e)	(f)	(g)	(h)
1-component meter	Main	Comp	-	-	-	-	-	-
2-component analyzer	NO/SO ₂	NO Main	NO Comp	SO ₂ Main	SO ₂ Comp	-	-	-
	CO ₂ /CO	CO ₂ Main	CO ₂ Comp	CO Main	CO Comp	-	-	-
	NO/CO	NO Main	NO Comp	-	-	CO Main	CO Comp	-
	N ₂ O/CO ₂	N ₂ O Main	N ₂ O Comp	CO ₂ Main	-	-	-	-
3-component analyzer	NO/SO ₂ /CO	NO Main	NO Comp	SO ₂ Main	SO ₂ Comp	CO Main	CO Comp	-
	NO/N ₂ O/CO ₂	NO Main	NO Comp	-	-	N ₂ O Main	N ₂ O Comp	CO ₂ Main
	SO ₂ /N ₂ O/CO ₂	SO ₂ Main	SO ₂ Comp	-	-	N ₂ O Main	N ₂ O Comp	CO ₂ Main
	N ₂ O/CO ₂ /CO	N ₂ O Main	N ₂ O Comp	CO ₂ Main	-	CO Main	CO Comp	-
	CH ₄ /N ₂ O/CO ₂	CH ₄ Main	CH ₄ Comp	-	-	N ₂ O Main	N ₂ O Comp	CO ₂ Main
4-component analyzer	NO/SO ₂ /CO ₂ /CO	NO Main	NO Comp	SO ₂ Main	SO ₂ Comp	CO ₂ Main	-	CO Main
	NO/SO ₂ /N ₂ O/CO ₂	NO Main	NO Comp	SO ₂ Main	SO ₂ Comp	N ₂ O Main	N ₂ O Comp	CO ₂ Main

* O₂ is excluded from the number of components.

* "Main" is signal input value from the main detector of each component.

"Comp" is signal input value from interference compensation detector of each component.

If low range exceeds the range of 0 to 10vol%, detector signal of "comp" is not usable.

Sensor values of which are not included in measuring components should be ignored.

- (3) Carry out the adjustment in the procedure in (4) and subsequent.
 - Adjust on the primary side of the optical system so that the values for ① to ④ in 1-1 and 1-2 become as close to 0 as possible within ± 100 range.
 - Adjust on the secondary side of the optical system so that the values for ⑤ to ⑧ in 2-1 and 2-2 become as close to 0 as possible within ± 100 range.

- (4) Operate the optical zero adjustment knob to change the value displayed at ① (or ⑤).
- (5) Move the beam adjustment plate sideview to change the value displayed at ② (or ⑥).
- (6) Move the beam adjustment plate sidewise to change the value displayed at ③ (or ⑦).
- (7) Move the beam adjustment plate sidewise to change the value displayed at ④ (or ⑧).
- (8) Repeat the procedures in (4) to (7) to make all the displayed values come close to 0 as possible within ± 100 range.

*** Adjust the beam adjustment plate which is the nearest to the zero adjustment knob first, and sequentially.**

- (9) After the optical balance adjustment, mount the top cover of the analyzer unit, then carry out a moisture interference compensation adjustment, and perform zero and span calibrations.

*** Before moving the beam adjustment plate, loosen the detector set bolts (just enough to make the plate movable for snug adjustment).**

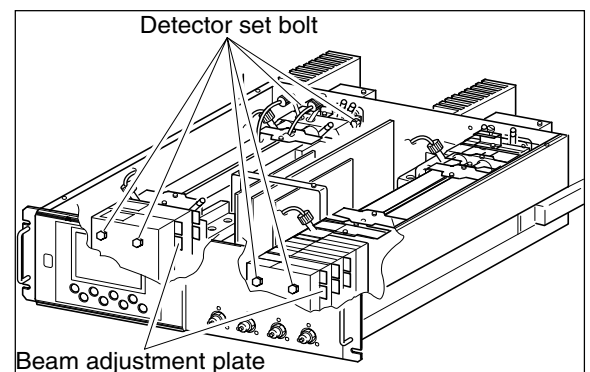
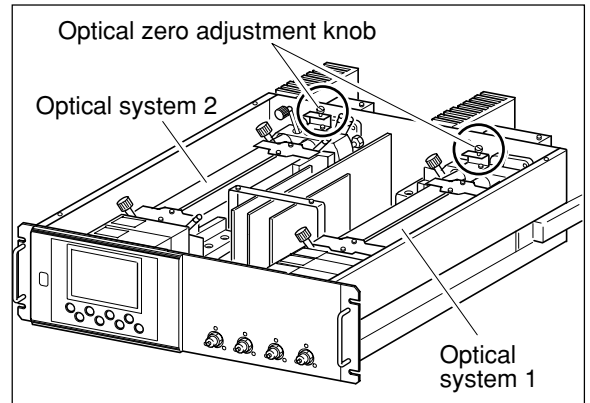

7.3.4 Moisture interference compensation adjustment method

Caution

If the following operation is maladjusted, the measurement may adversely be affected. If you are not trained for adjustment, do not carry out this operation but contact the distributor or our service-man.

Proceed to an adjustment if excessively (beyond $\pm 2\%$ FS) affected by moisture interference.

After the end of optical balance adjustment, be sure to carry out moisture interference compensation adjustment.

- (1) After warm-up, select the low range, allow dry gas (N_2 , air) to flow at 0.5 L/min and carry out zero calibration.

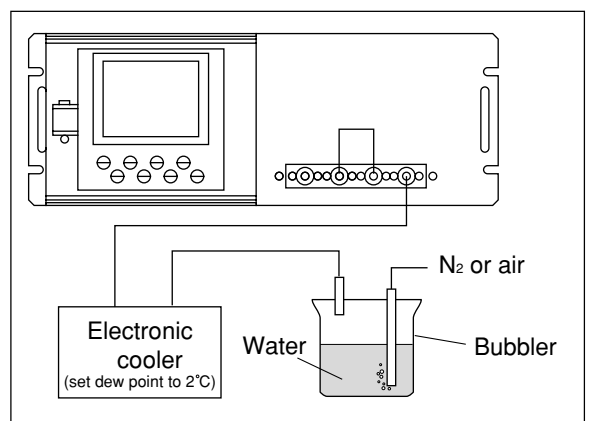

(2) Display the moisture interference compensation screen of the analyzer unit (see “6.8 Maintenance mode”). Set the dew point to 2°C by using an electronic cooler, and introduce bubbled N₂ or air gas to the analyzer (shown on the figure).

(3) On the screen, select a desired Ch (component) by pressing the **ENT** key, adjust the value at right by pressing the **▲** or the **▼** key so that the value at left falls within ±10 (make it as close to 0 as possible), and then press the **ENT** key to memorize the value. (Exiting by “**ESC**” cancels the adjustment.)

Or, selecting the “ALL” and pressing the “**ENT**” key, zeroes all components integrally.

(First, adjust all components by selecting ALL and then perform fine adjustment for components one by one using UP and DOWN keys.)

* If any components exceed the range of 0 to 10vol%, no adjustment can be performed (No interference compensation is required).

Moisture interference Compensation Adj.		Select Ch No. with UP / DOWN and ENT Back with ESC	
▣ Ch1	NO _x	10	1.252
Ch2	SO ₂	-33	0.983
Ch3	CO ₂	13	0.000
Ch4	CO	20	1.922
ALL			
Valve OFF			



Moisture interference Compensation Adj.		Adjust with UP / DOWN ENT : Memorized ESC : Back	
Ch1	NO _x	10	1.252
Ch2	SO ₂	-33	0.983
Ch3	CO ₂	13	0.000
Ch4	CO	20	1.922
ALL			
Valve OFF			

8 ERROR MESSAGE

If errors occur, the following contents are displayed.

Error display	Error contents	Probable causes
Error No.1	Motor rotation detection signal faulty	<ul style="list-style-type: none"> • Motor rotation is faulty or stopped. • Motor rotation detector circuit is faulty. Note) Sector motor is a consumption part. It is recommendable to exchange the motor once two years.
Error No.4	Zero calibration is not within.	<ul style="list-style-type: none"> • Zero gas is not supplied. • Zero is deflected much due to dirty cell. • Detector is faulty. • Optical balance is maladjusted.
Error No.5	Amount of zero calibration (indication value) is over 50% of full scale.	
Error No.6	Span calibration is not within the allowable range.	<ul style="list-style-type: none"> • Span gas is not supplied. • Calibrated concentration setting does not match cylinder concentration. • Zero calibration is not performed normally. • Span is deflected much due to dirty cell. • Detector sensitivity has deteriorated.
Error No.7	Amount of span calibration (difference between indication value and calibrated concentration) is over 50% of full scale.	
Error No.8	Measured values fluctuate too much during zero and span calibration.	<ul style="list-style-type: none"> • Calibration gas is not supplied. • Time for flowing calibration gas is short.
Error No.9	Calibration is abnormal during auto calibration.	<ul style="list-style-type: none"> • Error corresponding to No. 4 to No. 8 occurred during auto calibration.
Error No.10	Output cable connection is improper.	<ul style="list-style-type: none"> • Wiring is detached between analyzer and interface module. • Wiring is disconnected between analyzer and interface module.

When errors No. 1 and No. 10 occur, analyzing block error contact output is closed.

When errors No. 4 to No. 9 occurs, calibration error contact output is closed.

Screen display and operation at the occurrence of error

In case of Error No. 1 to No. 4, No. 6, No. 8 to No. 10

Measurement screen

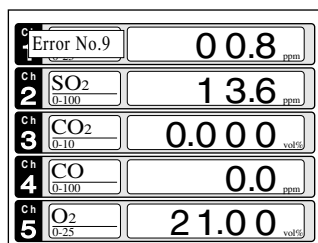

- Press the **ESC** key to delete the error display.
- If the **ESC** key is pressed without removing the cause of an error, the error will be displayed again.

Display of error contents

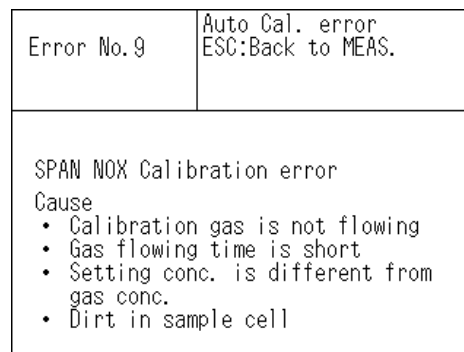

- When more than one error occurs, pressing the **▶** key moves to another error display.

In case of Error No. 5 and No. 7

ZERO cal.		ENT:Go on calibration of selected CH ESC:Not calibration	
Ch1 NO _x	▶ Error No. 5	ppm ppm	3083
Ch2 SO ₂	▶ Range1 0-100 Range2 0-2000	ppm ppm	-13.6
Ch3 CO ₂	▶ Range1 0-10 Range2 0-20	vol% vol%	-0.006
Ch4 CO	▶ Range1 0-100 Range2 0-2000	ppm ppm	0.2
Ch5 O ₂	▶ Range1 0-10 Range2 0-25	vol% vol%	-0.09

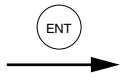

Error No. 5	SPAN cal. error ENT:Force Cal. ESC:Stop cal. and back to MEAS.
NO _x Calibration error Cause <ul style="list-style-type: none"> • Span gas is not flowing • Deviation of zero point due to contamination • Low sensitivity of detector 	

• Pressing delete the error display.

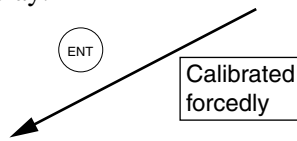

Calibration is continued. Unless another calibration error occurs, calibration is carried out to the end, the Measurement screen returns.

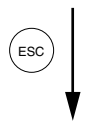

Ch 1	NO ₂ <small>0-25</small>	90.8 <small>ppm</small>
Ch 2	SO ₂ <small>0-100</small>	13.6 <small>ppm</small>
Ch 3	CO ₂ <small>0-10</small>	0.000 <small>vol%</small>
Ch 4	CO <small>0-100</small>	0.0 <small>ppm</small>
Ch 5	O ₂ <small>0-25</small>	0.09 <small>vol%</small>

Error log file

If error occurs, the history is saved in an error log file. The error log file exists in the maintenance mode.

Error log screen

Maintenance Mode		ENT : Clear Error Log ESC : Back				
Error Log						
Error No.	Y	M	D	H	M	Ch
No. 4	04	2	11	18	10	5
No. 1	04	1	10	12	2	1
No. 6	03	12	1	10	10	2
No. 9	03	12	1	10	10	2
No. 5	03	12	1	0	0	2
No. 9	03	12	1	0	0	2
Next page		Page 1				
▶ Clear Error Log						

Annotations:
 - Date and time when an error occurred. (points to Y, M, D, H, M)
 - Component with which the error occurred. (points to Ch)
 - Errors that occurred (points to the list of error rows)
 - New / Old (vertical arrow pointing down)

* Up to 14 errors can be saved in the error history; the oldest error will be deleted one by one every time a new occurs.

* If the power supply is turned OFF, the contents in the error log file will not be lost or damaged.

Deletion of error history

Press the key on the above screen, and the “Error Log Clear” will be inverted. Further pressing the key will clear the error history.

9. SPECIFICATIONS

9.1 General specifications

1. Standard specifications

Measurable gas components and measuring range:

	Minimum range	Maximum range
NO	0 – 50ppm	0 – 5000ppm
SO ₂	0 – 50ppm	0 – 10vol%
CO ₂	0 – 20ppm	0 – 100vol%
CO	0 – 50ppm	0 – 100vol%
CH ₄	0 – 200ppm	0 – 100vol%
N ₂ O	0 – 200ppm	0 – 2000ppm
O ₂ (built in)	0 – 5vol%	0 – 25vol%
O ₂ (External Zirconia)	0 – 5vol%	0 – 25vol%

- Max. 5 components measurement including O₂.
- Measuring range ratio $\leq 1:5$ (O₂) $\leq 1:25$ (except for O₂)
- Measuring ranges are changeable between the specified minimum and maximum range
Settable one range or two ranges
- When only N₂O analyzer is used, make sure not to contain any components other than N₂O.
Multicomponent analyzers including N₂O analyzer + CO₂ analyzer are used for sludge incineration.
In this case, the range of N₂O is 0 to 200ppm/500ppm, and the range of CO₂ is 0 to 10%/20%.

Principle of measurement:

No, SO₂, CO₂, CO, CH₄, N₂O ;

Non-dispersion infrared-ray absorption method
Single light source and double beams (double-beam system)

O₂ ; Paramagnetic O₂ sensor (built in) or zirconia O₂ sensor (externally installed)

Measured value indication:

- Digital indication in 4 digits (LCD with back light)
- Instantaneous value of each component
 - Instantaneous value after O₂ conversion (only in NO, SO₂, CO measurement with O₂)
 - Average value after O₂ conversion (only in NO, SO₂, CO measurement with O₂)
 - O₂ average value

Analog output signals:

* Inputs/outputs of analog signals are possible by combining with the input/output terminal module.

4 to 20mA DC or 0 to 1V DC, non-isolated output ; 12 points max.
max.load 550Ω. for 4 to 20 mA DC
min.load 100kΩ. for 0 to 1V DC

* Refer to Table 2, for the channel No. of

displayed values and analog output signals.

Analog input signal:

For signal input from externally installed O₂ sensor.

Signal requirement;

(1) Signal from Fuji's Zirconia O₂ sensor (TYPE: ZFK7)

(2) 0 to 1V DC from an O₂ sensor

Input section is not isolated. This feature is effective when an O₂ sensor is not built in.

(Depend on O₂ input signal, measured concentration indication and O₂ conversion.)

Relay Contact output:

1a contact (250V AC/2A, resistive load)

Instrument error, calibration error, range identification, auto calibration status, pump ON/OFF, peak alarm.

1c contact (250V AC/2A, resistive load selectable 6 outputs)

High/Low limit alarm contact output.
Power disconnection alarm.

* All relay contacts are isolated mutually and from the internal circuit.

Contact input: No-voltage contact (ON/0V, OFF/5V DC, 5mA flowing at ON)

Remote range switch, auto calibration remote start, remote holding, average value resetting, pump ON/OFF

Isolated from the internal circuit with photocoupler. Contact inputs are not isolated from one another.

Transmission output:

Solenoid valve drive signal for automatic calibration.

Transistor output (100mA or less)

Power supply: Voltage rating ; 100V to 240V AC

Allowable range ; 85V to 264V AC

Frequency ; 50Hz/60Hz

Power consumption; 250VA max.

Inlet ; Conform to EN60320
Protection Class 1

Operation conditions:

Ambient temperature ; -5°C to 45°C

Ambient humidity ; 90% RH max.,
non-condensing

Storage conditions:

Ambient temperature ; -20°C to 60°C

Ambient humidity ; 100% RH max.,
non-condensing

Dimensions (H × W × D):

Analyzer main unit;

177 x 483 x 600mm

Input/output terminal module;

164 x 318 x 55mm

Mass: Approx. 22 kg (only Analyzer)

Finish color: Front panel ; Off-white (Munsell 10Y7.5/0.5 or equivalent)

Casing; Steel-blue (gray)

Enclosure: Steel casing, for indoor use

Material of gas-contacting parts:

Gas inlet/outlet; SUS304
Sample cell; SUS304, chloroprene rubber
Infrared-ray transmitting window; CaF₂
O₂ sensor sample cell : SUS316
Internal piping; Toaron, Teflon

Gas inlet/outlet: Rc1/4 or NPT1/4 internal thread

Purge gas flow rate: 1L/min (when required)

2. Standard Functions

Output signal holding:

Output signals are held during manual and auto calibrations by activation of holding (turning "ON" its setting).

The values to be held are the ones just before start calibration mode or setting value. It is selectable.

Indication of instantaneous values will not be held.

Remote output holding:

Output signal is held at the latest value or setting value by short-circuiting the remote output holding input terminals.

Holding is maintained while the terminals are short-circuited. Indication of instantaneous values will not be held.

Switch ranges:

The switch ranges is available in manual, auto, and remote modes. Only preset switch method is effective.

Manual: Allows range to switch by key operation.

Auto: Allows range to switch from low to high range when 90%FS or more is available in the low range.

Allows range to switch from high to low range when 80%FS or less is available in the low range.

Remote: No-voltage contact input (for measurable components)

Allows range to switch via an external signal when remote range switch input is received.

When the contact input terminals for each component are short-circuited, the first range is selected, and it is switched to the second range when the terminals are open.

Range identification signal:

The present measuring range is identified by a contact signal.

The contact output terminals for each component are short-circuited when the first range is selected, and when the second range is selected, the terminals are open.

Auto calibration:

Auto calibration is carried out periodically at the preset cycle.

When a standard gas cylinder for calibration and a solenoid valve for opening/closing the gas flow line are prepared externally by the customer, calibration will be carried out with the solenoid valve drive contacts for zero calibration and each span calibration turned on/off sequentially at the set auto calibration timing.

Auto calibration cycle setting:

Auto calibration cycle is set.

Setting is variable within 1 to 99 hours (in increments of 1 hour) or 1 to 40 days (in increments of 1 day).

Gas flow time setting:

The time for flowing each calibration gas in auto calibration is set.

Settable within 60 to 900 seconds (in increments of 1 second)

Auto calibration remote start:

Auto calibration is carried out only once according to an external input signal. Calibration sequence is settable in the same way as the general auto calibration. Auto calibration is started by opening the auto calibration remote start input terminals after short-circuiting for 1.5 seconds or longer.

Auto zero calibration:

Auto zero calibration is carried out periodically at the preset cycle.

This cycle is independent on "Auto calibration" cycle.

When zero calibration gas and solenoid valve for opening/closing the calibration gas flow line are prepared externally by the customer, zero calibration will be carried out with the solenoid valve drive contact for zero calibration turned on/off at the set auto zero calibration timing.

Auto zero calibration cycle setting:

Auto zero calibration cycle is set.

Setting is variable within 1 to 99 hours (in increments of 1 hour) or Setting is variable within 1 to 40 days (in increments of 1 day)

Gas flow time setting:

The timing for flowing zero gas in auto zero calibration is set.

Settable 60 to 900 seconds (in increments of 1 second)

Upper/lower limit alarm:

Alarm contact output turns on when measurement value reach to the preset high or low limit alarm value.

Contacts close when the channel value of each channel becomes larger than the high alarm limit value or smaller than the low alarm limit value.

Instrument error contact output:

Contacts close at occurrence of analyzer error No. 1, 3 or 10.

Calibration error contact output:

Contacts close at occurrence of manual or auto calibration error (any of errors No. 4 to 9).

Auto calibration status contact outputs:

Contacts close during auto calibration.

Pump ON/OFF contact output:

During measurement, this contact close. While calibration gas is flowing, this contact open. This contact is connected in power supply of pump, and stop the sample gas while calibration gas flowing.

3. Optional function

O₂ conversion: Conversion of measured NO, SO₂ and CO gas concentrations into values at reference O₂ concentration

Conversion formula:

$$C = \frac{21 - O_n}{21 - O_s} \times C_s$$

C : Sample gas concentration after O₂ conversion

C_s : Measured concentration of sample gas

O_s : Measured O₂ concentration (Limit setting: 1 to 20% O₂)

O_n : Reference O₂ concentration (value changeable by setting 0 to 19% O₂)

Average value after O₂ conversion and O₂ average value calculation:

The result of O₂ conversion or instantaneous O₂ value can be outputted as an average value in the preset period of time.

Used for averaging is the moving average method in which sampling is carried out at intervals of 30 seconds.

(Output is updated every 30 seconds. It is the average value in the determined period of time just before the latest updating.)

Averaging time is settable within 1 to 59 minutes (in increments of 1 minute) or 1 to 4 hours (in increments of 1 hour).

Average value resetting:

The above-mentioned output of average value is started from the initial state by opening the average value resetting input terminals after short-circuiting for 1.5 seconds or longer.

Output is reset by short-circuiting and restarted by opening

CO concentration peak count alarm:

(added only for CO/O₂ measurement)

Alarm output turns on according to the preset concentration and count.

Whenever the instantaneous value of CO exceeds the preset concentration value, count increments. If the count exceeds the preset value in one hour, the alarm contacts close.

Communication function:

RS-232C (9pins D-sub)

Half-duplex bit serial

Start-stop synchronization

Modbus™ protocol

Contents : Read/Wright parameters

Read measurement concentration and instrument status

Remark : When connecting via RS-485 interface, a RS-232C ↔ RS-485 converter should be used.

4. Performance

Repeatability : ±0.5% of full scale

Linearity : ±1% of full scale

Zero drift : ±1% of full scale/week

(±2% of full scale/week; range between 0 to 50ppm and 0 to 200ppm)

(±2% of full scale/day; smaller than 0 to 50ppm range)

Span drift : ±2% of full scale/week

(±2% of full scale/day; smaller than 0 to 50ppm range)

Response time (for 90% FS response) :

15 sec electrical response

Within 60 seconds including replacement time of sampling gas (when gas flow rate is 0.5L/min)

Gas replacement time depends on the number of measuring components, and measuring range

5. Standard Requirements for Sample Gas

Flow rate : 0.5L / min ± 0.2L / min

Temperature : 0 to 50°C

Pressure : 10 kPa or less (Gas outlet side should be open to the atmospheric air.)

Dust : 100µg/Nm³ in particle size of 1µm or less

Mist : Unallowable

Moisture : Below a level where saturation occurs at 2°C (condensation unallowable).

Corrosive component:

1 ppm or less

Standard gas for calibration:

Zero gas ; Dry N₂

Span gas ; Each sample gas having concentration 90 to 100% of its measuring range (recommended).

Gas beyond concentration 100%FS is unusable.

In case a zirconia O₂ analyzer is installed externally and calibration is carried out on the same calibration gas line:

Zero gas ; Dry air or atmospheric air (provided without CO₂ sensor)

Span gas ; For other than O₂ measurement, each sample gas having concentration 90 to 100% of its measuring range.

For O₂ measurement, O₂ gas of 1 to 2 vol%.

6. Installation Requirements

- Indoor use. (Select a place where the equipment does not receive direct sunshine, draft/rain or radiation from hot substances. If such a place cannot be found, a roof or cover should be prepared for protection.)
- Avoid a place where receives heavy vibration.
- Select a place where atmospheric air is clean.

7. EC Directive Compliance

The product conforms to the requirements of the Low Voltage Directive 73/23/EEC and EMC directive 89/336/EEC (as amended by Directive 92/31/EEC), both as amended by Directive 93/68/EEC.

It conforms to following standards for product safety and electromagnetic compatibility ;

EN61010-1 : 2001 Safety requirements for electrical equipment for measurement, control and laboratory use.
"Installation Category II"
"Pollution Degree 2"

EN61326-1 : 1997, A1: 1998, A2: 2001
Electrical equipment for measurement, control and laboratory use — EMC requirements.

* The product mounted in a steel enclosure conforms to the requirements of EMC directive.

9.2 Code symbols

Basic type: ZKJ □□□□ 4- □□□□□□□ - □□□□□□□ - □□□□

Digit	Description	note	1	2	3	4	5	6	7	8	9	10	11	12	13	14	15	16	17	18	19	20	21	22	23	
4	<Custom specifications> Standard		Z	K	J	F	4																			
5	<Measurable component (SO ₂ , CO ₂ , CO, CH ₄ , N ₂ O)> 1st component 2nd component 3rd component 4th component NO SO ₂ CO ₂ CO CH ₄ NO SO ₂ NO CO CO ₂ CO NO SO ₂ CO NO SO ₂ CO ₂ CO N ₂ O N ₂ O CO ₂ note 10 NO N ₂ O CO ₂ note 10 SO ₂ N ₂ O CO ₂ note 10 N ₂ O CO ₂ CO note 10 CH ₄ N ₂ O CO ₂ note 10 NO SO ₂ N ₂ O note 10 NO					P A D B E F H G L M O Q R S T U V W																				
6	<Measurable component (O ₂)> None External zirconia type O ₂ sensor (Model : ZFK7) External O ₂ analyzer Built-in paramagnetic type O ₂ sensor	note 1b) note 1a/b)									Y A B C															
7	<Gas inlet/outlet> Rc ¹ / ₄ Rc ¹ / ₄ , with purging NPT ¹ / ₄ NPT ¹ / ₄ , with purging Resin(ø6)	note 2a) note 2a) note 2b)								0 1 2 3 4																
8	<Revision code>									4																
9	<Accessories> None With relay board for auto calibration, with cable With slide rail With slide rail, relay board, and cable										Y A C D															
10	<Indication and power supply cable> In Japanese, Power cable rated 125V In English, Power cable rated 125V (UL) In English, Power supply rated 250V (CEE)	note 3									J E U															
11	<Measuring range> 1st component	note 4																								
12	Minimum range Maximum range 0 to 20ppm 0 to 500ppm 0 to 50ppm 0 to 1000ppm 0 to 100ppm 0 to 2000ppm 0 to 200ppm 0 to 500ppm 0 to 200ppm 0 to 2000ppm 0 to 200ppm 0 to 5000ppm 0 to 500ppm 0 to 1% 0 to 1000ppm 0 to 2% 0 to 2000ppm 0 to 5% 0 to 5000ppm 0 to 10% 0 to 1% 0 to 20% 0 to 2% 0 to 10% 0 to 2% 0 to 50% 0 to 10% 0 to 20% 0 to 10% 0 to 100%	note 5										1 E A F B G C E C G C H E J F K G L H M J N K M K P M N M R														
13	<Measuring range> 2nd component	note 4																								
14	Minimum range Maximum range None None 0 to 50ppm 0 to 1000ppm 0 to 100ppm 0 to 2000ppm 0 to 200ppm 0 to 500ppm 0 to 200ppm 0 to 2000ppm 0 to 200ppm 0 to 5000ppm 0 to 500ppm 0 to 1% 0 to 1000ppm 0 to 2% 0 to 5000ppm 0 to 10% 0 to 1% 0 to 20% 0 to 2% 0 to 50% 0 to 10% 0 to 20% 0 to 10% 0 to 100%												Y - Y A - F B - G C - E C - G C - H E - J F - K H - M J - N K - P M - N M - R													
15	<Measuring range> 3rd component	note 4																								
16	Minimum range Maximum range None None 0 to 50ppm 0 to 1000ppm 0 to 100ppm 0 to 1000ppm 0 to 100ppm 0 to 2000ppm 0 to 200ppm 0 to 500ppm 0 to 200ppm 0 to 2000ppm 0 to 200ppm 0 to 5000ppm 0 to 500ppm 0 to 1% 0 to 1000ppm 0 to 2% 0 to 2000ppm 0 to 5% 0 to 5000ppm 0 to 10% 0 to 1% 0 to 20% 0 to 2% 0 to 10% 0 to 10% 0 to 20% 0 to 10% 0 to 100%																									

Digit	Description	note	1	2	3	4	5	6	7	8	9	10	11	12	13	14	15	16	17	18	19	20	21	22	23
17	<Measuring range> 4th component	note 4	Z	K	J	F				4															
18	Minimum range	Maximum range																							
	None	None																		Y	Y				
	0 to 50ppm	0 to 1000ppm																		A	F				
	0 to 100ppm	0 to 2000ppm																		B	G				
	0 to 200ppm	0 to 500ppm																		C	E				
	0 to 200ppm	0 to 200ppm																		C	G				
	0 to 200ppm	0 to 500ppm																		C	H				
	0 to 500ppm	0 to 1%																		E	J				
	0 to 1000ppm	0 to 2%																		F	K				
	0 to 5000ppm	0 to 10%																		H	M				
	0 to 1%	0 to 20%																		J	N				
	0 to 2%	0 to 50%																		K	P				
	0 to 10%	0 to 20%																		M	N				
	0 to 10%	0 to 100%																		M	R				
19	<O ₂ analyzer, 1st range>	note 4																							
20	Minimum range	Maximum range																							
	None	None																			Y	Y			
	0 to 5%	0 to 25%																		L	V				
	0 to 10%	0 to 25%																		M	V				
	Other																			Z	Z				
21	<Output> 4 to 20mA DC 0 to 1V DC 4 to 20mA DC + Communication function 0 to 1V DC + Communication function																						A	B	C
22	<O ₂ conversion and O ₂ average value output> None With O ₂ conversion output With peak alarm With O ₂ conversion output and peak alarm	note 6 note 7																						Y	A
23	<Adjustment, Range designation> For combustion exhaust gas (specified range) For combustion exhaust gas For combustion exhaust gas (specified range) Unit mg/m ³ For combustion exhaust gas, Unit mg/m ³ Others	note 8a) note 8a)b) note 8b) note 9																						B	E
																								F	G
																								Z	Z

- Note 1** a) When "B" is specified at the 6th digit, O₂ sensor signal has to be set as 0-1V DC linear corresponding to full scale.
b) External Zirconia O₂ sensor and external O₂ analyzer are not included in the scope of supply, and has to be separately ordered.
- Note 2** a) When "H", "L" and "M" with purging are specified at 5th digit, only one set of gas inlet/outlet is provided.
In this case, NO₂/NO converter cannot be mounted in between of two measuring cells.
b) Resin coupling with purging cannot be manufactured.
- Note 3** Rated voltage and plug type of the attached power cable is different depending on the code "J", "E" and "U" in the 10th digit.
Select appropriate code according to operation power supply voltage in the final destination.
- Note 4** Measuring range can be selected within either the minimum or maximum range.
(Within min. or max. range, you can change the actual range settings locally.)
Initial setting from Fuji factory is Min. range for the 1st range, and Max. range for the 2nd range.
When range preset at Fuji factory is required, please select "specified range" at 23rd digit and inform Fuji of specified range table.
Refer to Table 1, for possible combination of measuring components and ranges in the data sheet.
- Note 5** "1E" can be specified at 11th & 12th digits, ONLY for CO₂ measurement.
In this case, be sure to select "with purging" at 7th digit.
- Note 6** O₂ conversion is calculated only for NO, SO₂ and CO.
Both average value output after O₂ calculation and O₂ average value output are provided at the same time.
a) Peak count alarm can be added only for CO measurement.
- Note 7** When "Y" is specified at the 6th digit, 22nd digit always has to be specified as "Y".
- Note 8** a) If you would like Fuji to deliver ZKJ analyzer with specific range setting, select "specified range" and separately inform Fuji of the actual range of each component together with your purchase order.
b) In case that the measurement unit is specified as "mg/m³", it is necessary to select "unit : mg/m³" (Code "F" or "G") at the 23rd digit.
Please refer to the table shown below for the corresponding range code based on "mg/m³".

Range code	Corresponding range in mg/m ³ or g/m ³							
	In ppm		NO		SO ₂		CO	
	Min. range	Max. range	Min. range	Max. range	Min. range	Max. range	Min. range	Max. range
AF	0-50ppm	0-1000ppm	0-70mg/m ³	0-1300mg/m ³	0-150mg/m ³	0-2800mg/m ³	0-65mg/m ³	0-1250mg/m ³
BG	0-100ppm	0-2000ppm	0-140mg/m ³	0-2600mg/m ³	0-300mg/m ³	0-5500mg/m ³	0-130mg/m ³	0-2500mg/m ³
CH	0-200ppm	0-5000ppm	0-280mg/m ³	0-6600mg/m ³	0-600mg/m ³	0-14g/m ³	0-250mg/m ³	0-6250mg/m ³

- Note 9** When "Z" is specified at the 23rd digit, a gas composition table of actual measured gas has to be sent to Fuji together with your purchase order.
- Note 10** When only N₂O analyzer is used, make sure not to contain any components other than N₂O.
Multicomponent analyzers including N₂O analyzer + CO₂ analyzer are used for sludge incineration.
In this case, the range of N₂O is 0 to 200ppm/500ppm, and the range of CO₂ is 0 to 10%/20%.

9.3 Outline diagram

<Analyzer main unit>

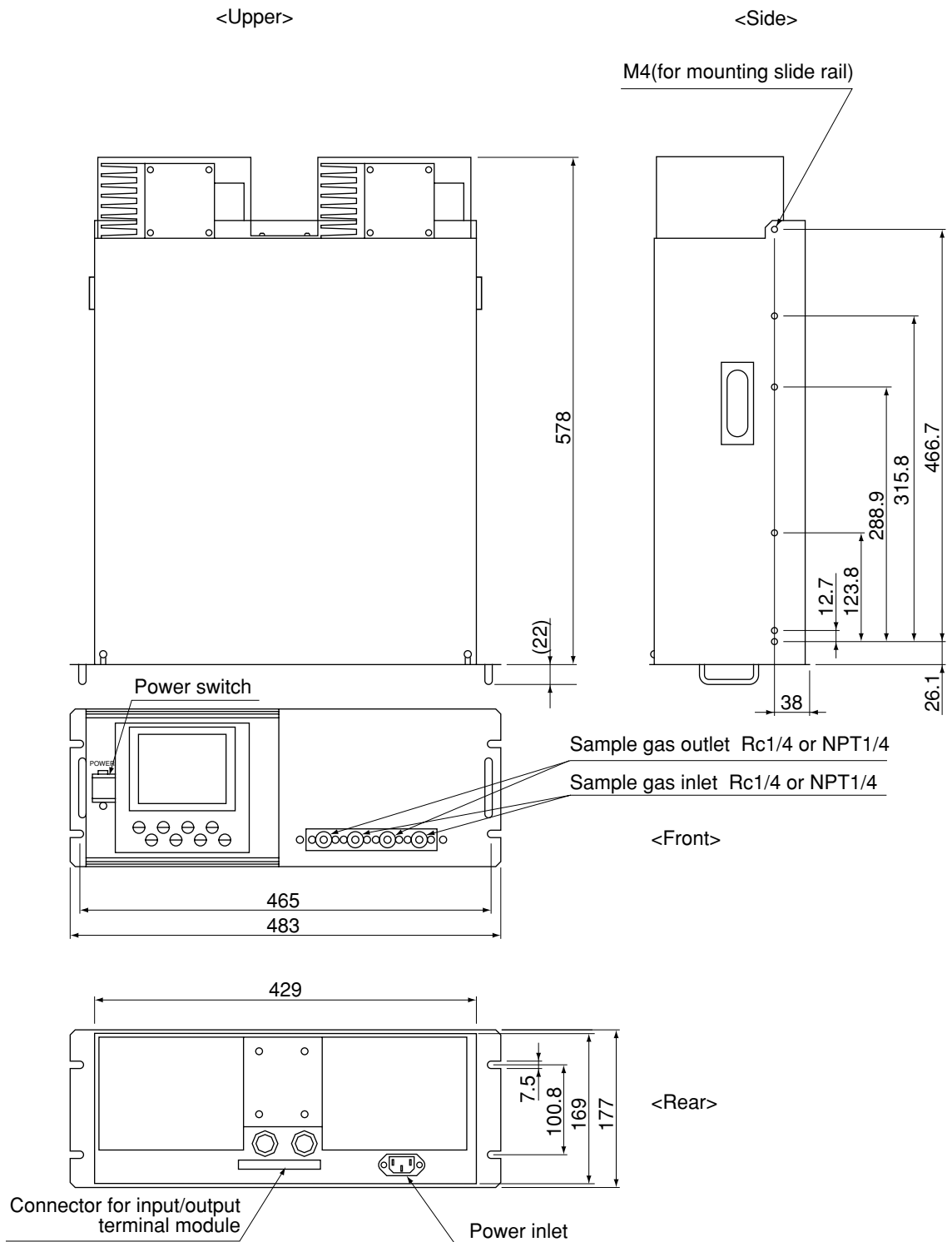

<Input/output terminal module>

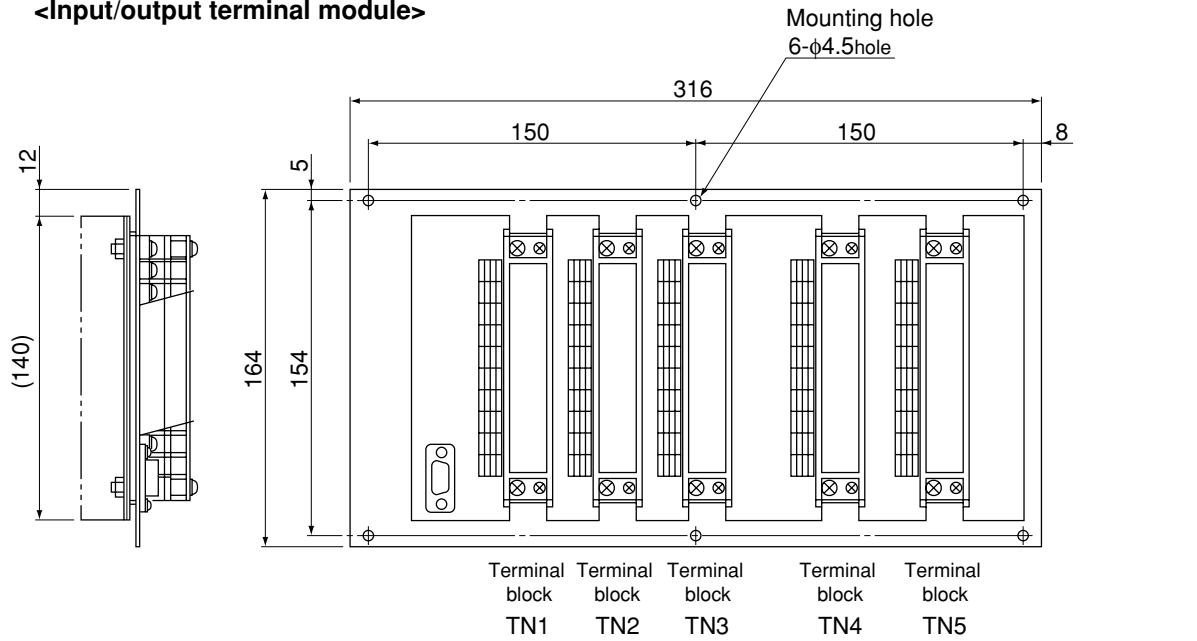

Screw-terminal
M 3.5

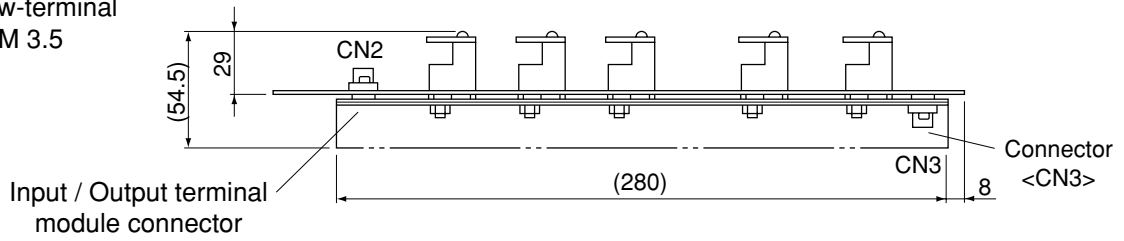

<Cable for connecting input /output terminal>

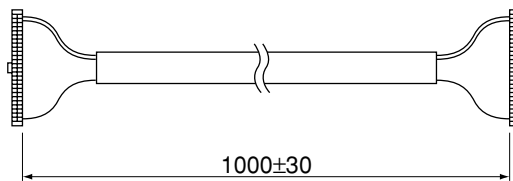

Outline diagram of accessory slide rail (unit: mm)

* The slide rails are attached to this equipment when designated.

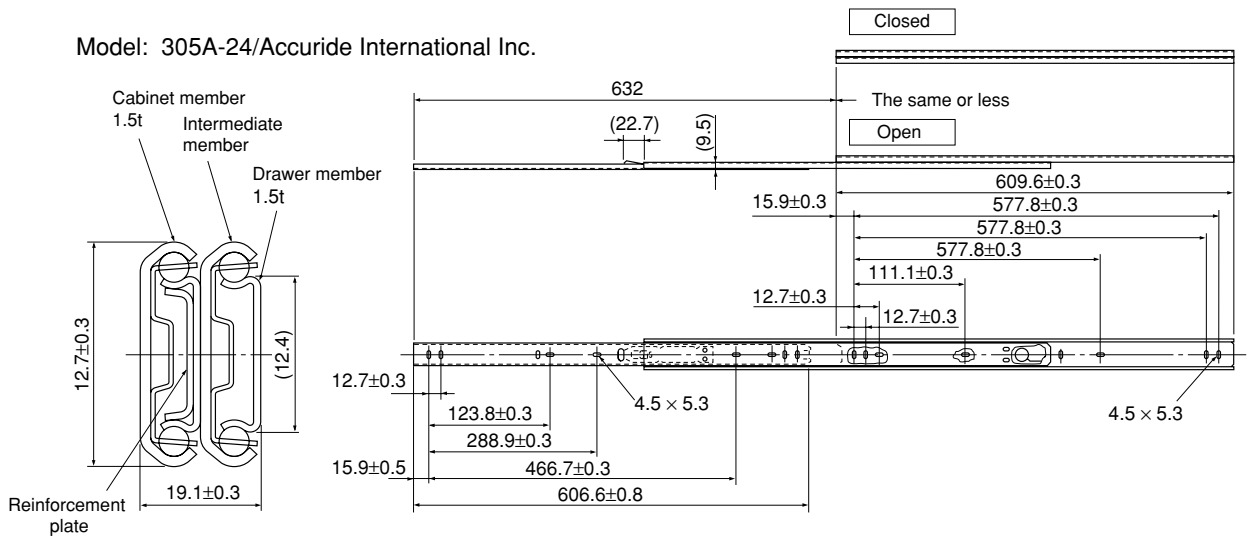

19 inch rack mounting method:

The instrument weight should be supported at the base (at the sides in case of slide rail method). For easy maintenance, it is recommended to select the method to allow withdrawing along the slide rail.

Slide rail mounting method

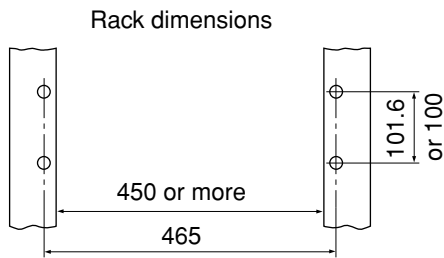

Guide rail mounting method

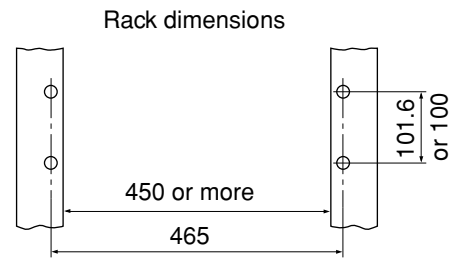

Mounting dimensions

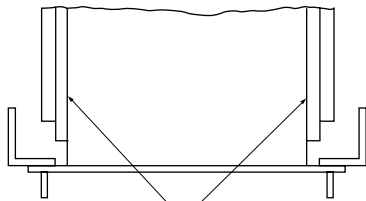

Slide rail

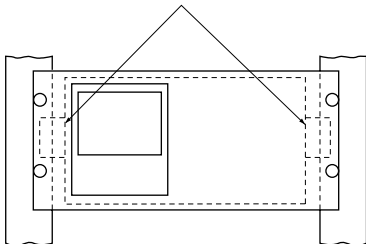

Mounting dimensions

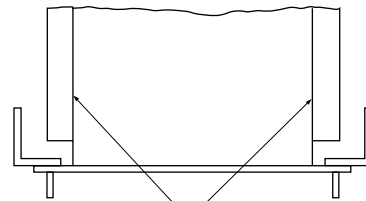

Guide rail

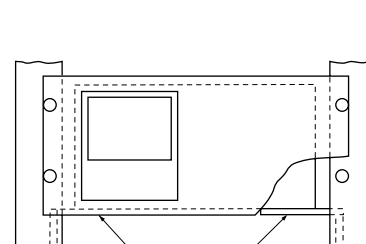

Guide rail

In selecting the guide rail mounting method, provide a maintenance space (200 mm or more) at top of the rack.

<<Exclusive relay board>

The relay board is used for receiving signals from connector CN3 of the ZKJ input/output terminal module and directly driving the solenoid valve for calibration.

- Relay contact : 1a contact
Contact capacity: 250V/2A AC (Resistance load)

OUTLINE DIAGRAM (Unit: mm)

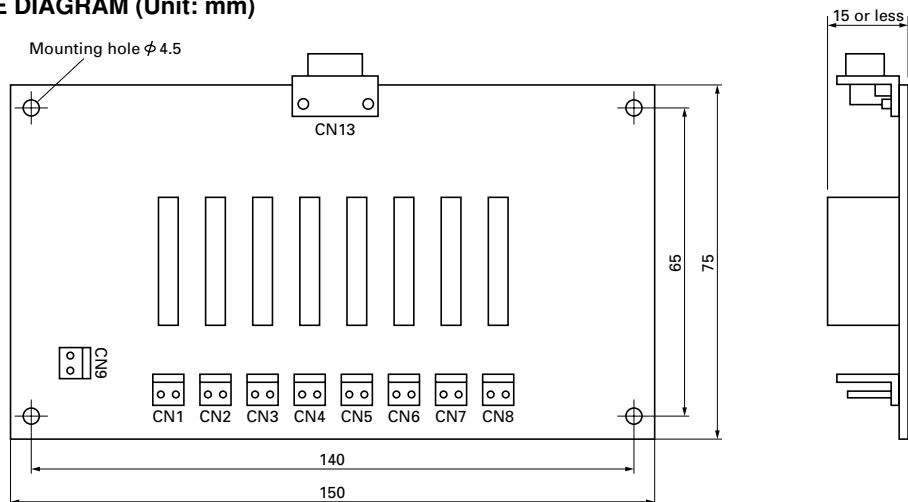

CONNECTIONS

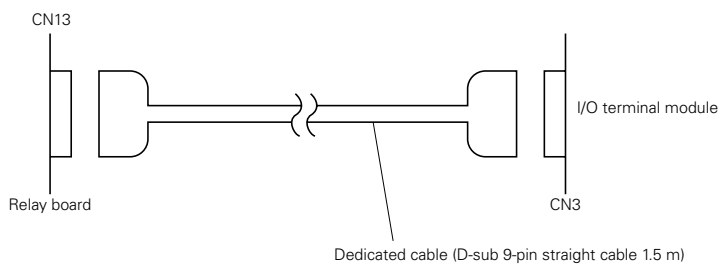
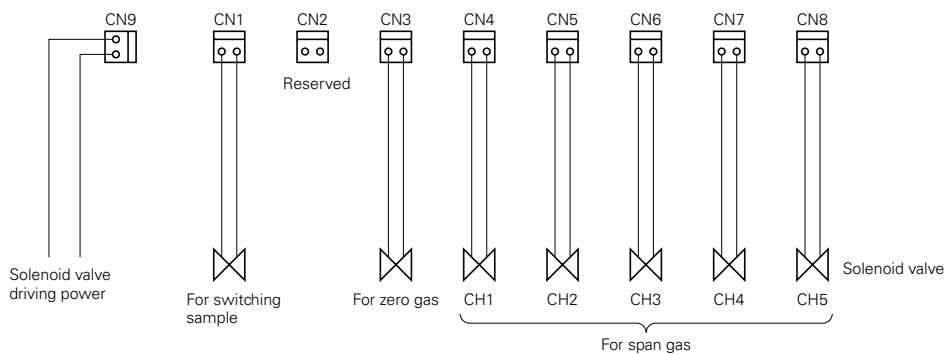

Contact operation

- At the time of measurement:
 - CN1 ON
 - Other OFF
- At the time of calibration:
 - CN1 OFF
 - Other Contacts corresponding to the timing of each calibration are ON.

Recommended connector

- CN1 to CN8:
 - Housing; VHR-2N (J.S.T. Mfg. Co., Ltd.)
 - Contact; SVH-21T-1.1 (J.S.T. Mfg. Co., Ltd.)

Fuji Electric Co., Ltd.

International Sales Div Sales Group

Gate City Ohsaki, East Tower, 11-2, Osaki 1-chome,
Shinagawa-ku, Tokyo 141-0032, Japan
<http://www.fujielectric.com>
Phone: 81-3-5435-7280, 7281 Fax: 81-3-5435-7425
<http://www.fujielectric.com/products/instruments/>
