

Direct Drive Turbo Blower

Unit: Inch

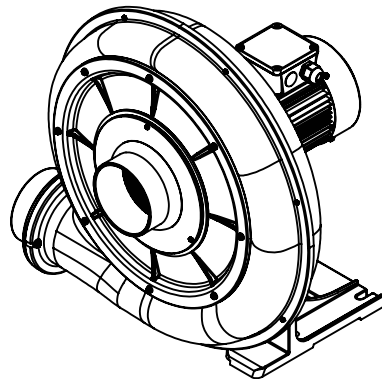
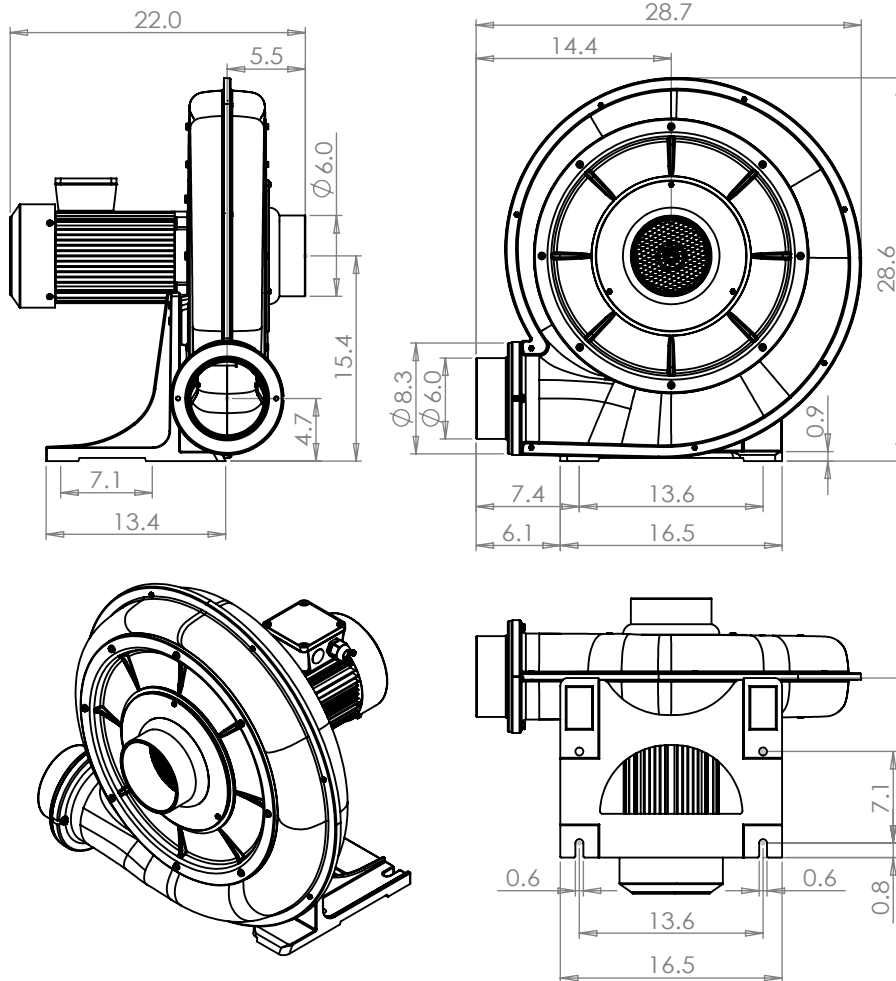

Specifications

Model	FDC-050A-7W
Phase	3
Voltage	208-240 / 415-480
Frequency (Hz)	60
Rated Output (HP)	5.0
Rated Current (Amps)	15.0 / 7.5
Max. Pressure (in. H ₂ O)	18.5
Max. Airflow (CFM)	1860.4
Noise Level dB (A)	99.0
Weight (lbs.)	136.9

Pressure

