

# FMW60N055S2HF

<http://www.fujielectric.com/products/semiconductor/>
**FUJI POWER MOSFET**

## Super J MOS<sup>®</sup> S2 series

**N-Channel enhancement mode power MOSFET**

### Features

- Pb-free lead terminal
- RoHS compliant
- uses Halogen-free molding compound

### Applications

- For switching

### Equivalent circuit schematic

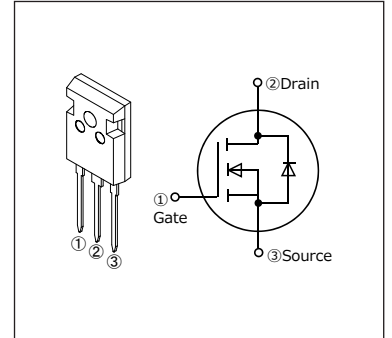

### Absolute Maximum Ratings at $T_c=25^\circ\text{C}$ (unless otherwise specified)

Parameter	Symbol	Characteristics	Unit	Remarks
Drain-Source Voltage	$V_{DS}$	600	V	
	$V_{DSX}$	600	V	$V_{GS}=-30\text{V}$
Continuous Drain Current	$I_D$	64.4	A	$T_c=25^\circ\text{C}$ Note*1,2
		40.7	A	$T_c=100^\circ\text{C}$ Note*1,2
Pulsed Drain Current	$I_{DP}$	200	A	Note *2
Gate-Source Voltage	$V_{GS}$	$\pm 30$	V	
Non-Repetitive Maximum Avalanche Current	$I_{AS}$	6.8	A	Note *3
Non-Repetitive Maximum Avalanche Energy	$E_{AS}$	1765.9	mJ	Note *4
Maximum Drain-Source $dV/dt$	$dV_{DS}/dt$	50	V/ns	$V_{DS} \leq 600\text{V}$
Continuous Diode Forward Current	$I_{SD}$	64.4	A	$T_c=25^\circ\text{C}$ Note*1,2
		40.7	A	$T_c=100^\circ\text{C}$ Note*1,2
Pulsed Diode Forward Current	$I_{SDP}$	200	A	Note *2
Peak Diode Recovery $dV/dt$	$dV/dt$	15	V/ns	Note *5
Peak Diode Recovery $-di/dt$	$-di/dt$	100	A/ $\mu\text{s}$	Note *6
Maximum Power Dissipation	$P_D$	2.50	W	$T_a=25^\circ\text{C}$
		340		$T_c=25^\circ\text{C}$
Operating and Storage Temperature range	$T_{ch}$	150	$^\circ\text{C}$	
	$T_{slg}$	-55 to +150	$^\circ\text{C}$	

Note \*1 : Maximum duty cycle  $D=0.60$

Note \*2 : Limited by maximum channel temperature.

Note \*3 :  $T_{ch} \leq 150^\circ\text{C}$ , See Fig.1 and Fig.2

Note \*4 : Starting  $T_{ch}=25^\circ\text{C}$ ,  $I_{AS}=4.1\text{A}$ ,  $L=193\text{mH}$ ,  $V_{DD}=60\text{V}$ ,  $R_G=50\Omega$ , See Fig.1 and Fig.2

$E_{AS}$  limited by maximum channel temperature and avalanche current.

Note \*5 :  $I_{SD} \leq 49.9\text{A}$ ,  $-di/dt \leq 100\text{A}/\mu\text{s}$ ,  $V_{DS\text{ peak}} \leq 600\text{V}$ ,  $T_{ch} \leq 150^\circ\text{C}$ .

Note \*6 :  $I_{SD} \leq 49.9\text{A}$ ,  $dV/dt \leq 15\text{V/ns}$ ,  $V_{DS\text{ peak}} \leq 600\text{V}$ ,  $T_{ch} \leq 150^\circ\text{C}$ .

■ Electrical Characteristics at  $T_c=25^\circ\text{C}$  (unless otherwise specified)

• Static Ratings

Parameter	Symbol	Conditions	min.	typ.	max.	Unit
Drain-Source Breakdown Voltage	$BV_{DSS}$	$V_{GS}=0V$ $I_D=250\mu A$	600	-	-	V
Gate Threshold Voltage	$V_{GS(th)}$	$V_{DS}=V_{GS}$ $I_D=2.76mA$	3.5	4.0	4.5	V
Zero Gate Voltage Drain Current	$I_{DSS}$	$V_{DS}=600V$ $V_{GS}=0V$ $T_{ch}=25^\circ\text{C}$	-	-	25	$\mu A$
		$V_{DS}=480V$ $V_{GS}=0V$ $T_{ch}=125^\circ\text{C}$	-	-	250	
Gate-Source Leakage Current	$I_{GSS}$	$V_{DS}=0V$ $V_{GS}=\pm 30V$	-	10	100	nA
Drain-Source On-State Resistance	$R_{DS(on)}$	$V_{GS}=10V$ $I_D=25A$	-	0.051	0.055	$\Omega$
Gate resistance	$R_G$	f=1MHz, open drain	-	6.2	-	$\Omega$

• Dynamic Ratings

Parameter	Symbol	Conditions	min.	typ.	max.	Unit
Forward Transconductance	$g_{fs}$	$V_{DS}=25V$ $I_D=25A$	17	34	-	S
Input Capacitance	$C_{iss}$	$V_{DS}=400V$ $V_{GS}=0V$ f=250kHz	-	2790	-	$\mu F$
Output Capacitance	$C_{oss}$		-	93	-	
Reverse Transfer Capacitance	$C_{rss}$		-	11.3	-	
Effective output capacitance, energy related (Note *7)	$C_{o(er)}$	$V_{DS}=0\dots 400V$ $V_{GS}=0V$	-	216	-	$\mu F$
Effective output capacitance, time related (Note *8)	$C_{o(tr)}$	$V_{DS}=0\dots 400V$ $V_{GS}=0V$ $I_D=\text{constant}$	-	877	-	$\mu F$
Turn-On Time	$t_{d(on)}$	$V_{DD}=400V, V_{GS}=10V$ $I_D=25A,$ $R_G=8.2\Omega$ See Fig.3 and Fig.4	-	29	-	ns
	$t_r$		-	113	-	
Turn-Off Time	$t_{d(off)}$		-	149	-	
	$t_f$		-	25	-	
Total Gate Charge	$Q_G$	$V_{DD}=400V, V_{GS}=10V$ $I_D=49.9A$ See Fig.5	-	110	-	nC
Gate-Source Charge	$Q_{GS}$		-	39	-	
Gate-Drain Charge	$Q_{GD}$		-	48	-	
Drain-Source crossover Charge	$Q_{SW}$		-	25	-	

Note \*7 :  $C_{o(er)}$  is a fixed capacitance that gives the same stored energy as  $C_{oss}$  while  $V_{DS}$  is rising from 0 to 400V.  
 Note \*8 :  $C_{o(tr)}$  is a fixed capacitance that gives the same charging times as  $C_{oss}$  while  $V_{DS}$  is rising from 0 to 400V.

• Reverse Diode

Parameter	Symbol	Conditions	min.	typ.	max.	Unit
Diode Forward On-Voltage	$V_{SD}$	$I_{SD}=49.9A, V_{GS}=0V$ $T_{ch}=25^\circ\text{C}$	-	0.95	1.35	V
Reverse Recovery Time	$t_{rr}$	$V_{DD}=400V, I_{SD}=49.9A$ -di/dt=100A/ $\mu s$ $T_{ch}=25^\circ\text{C}$ See Fig.6 and Fig.7	-	420	-	ns
Reverse Recovery Charge	$Q_{rr}$		-	8	-	$\mu C$
Peak Reverse Recovery Current	$I_{rp}$		-	37	-	A

■ Thermal Resistance

Parameter	Symbol	min.	typ.	max.	Unit
Channel to Case	$R_{th(ch-c)}$	-	-	0.368	$^\circ\text{C}/\text{W}$
Channel to Ambient	$R_{th(ch-a)}$	-	-	50	$^\circ\text{C}/\text{W}$

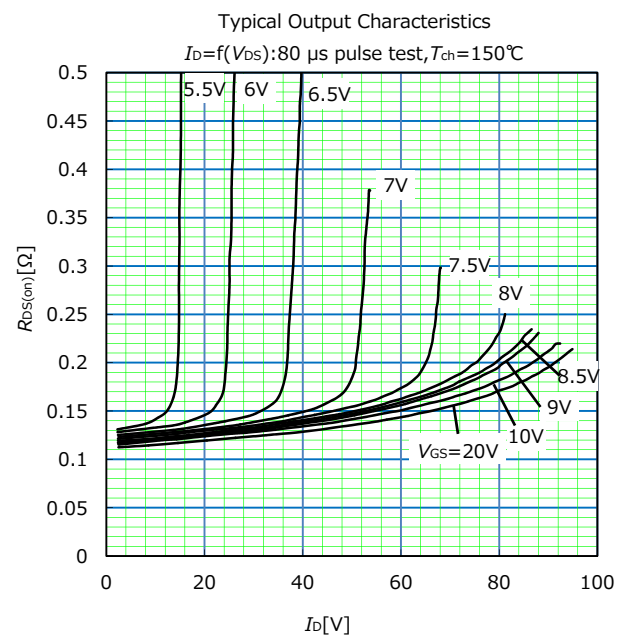
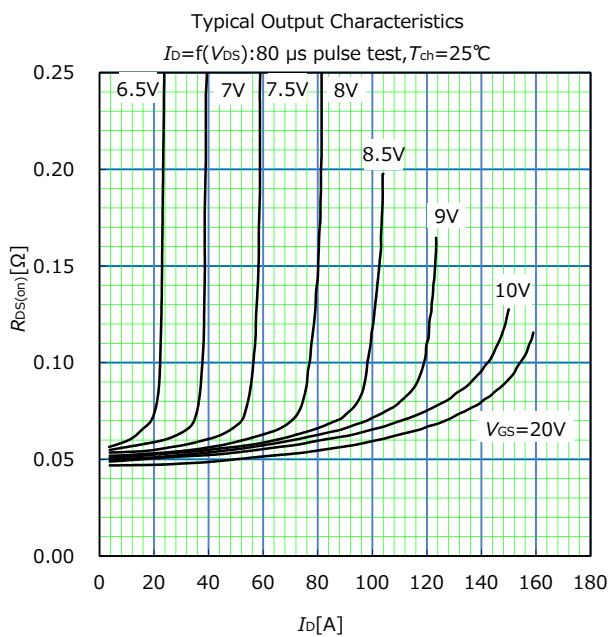
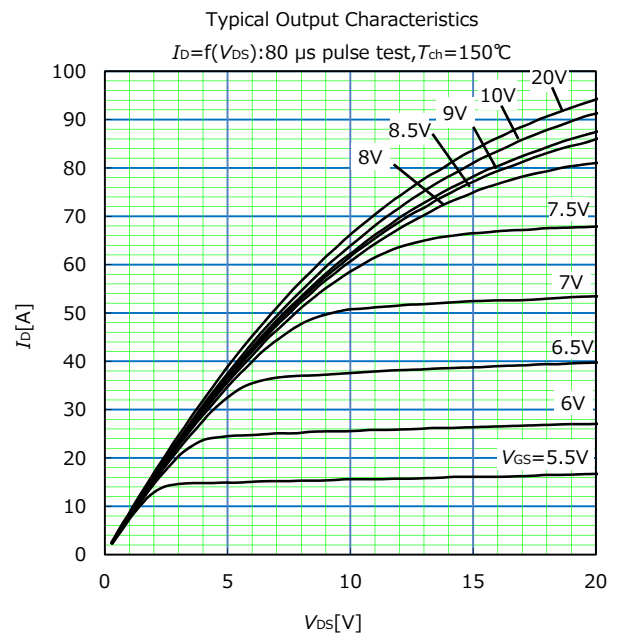
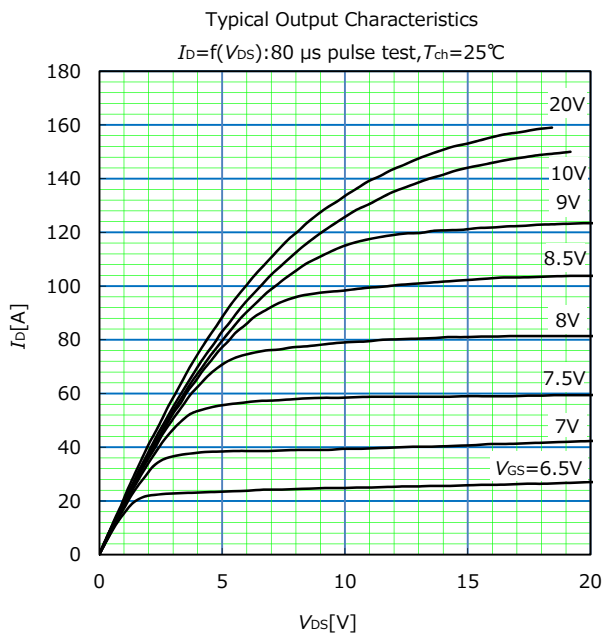
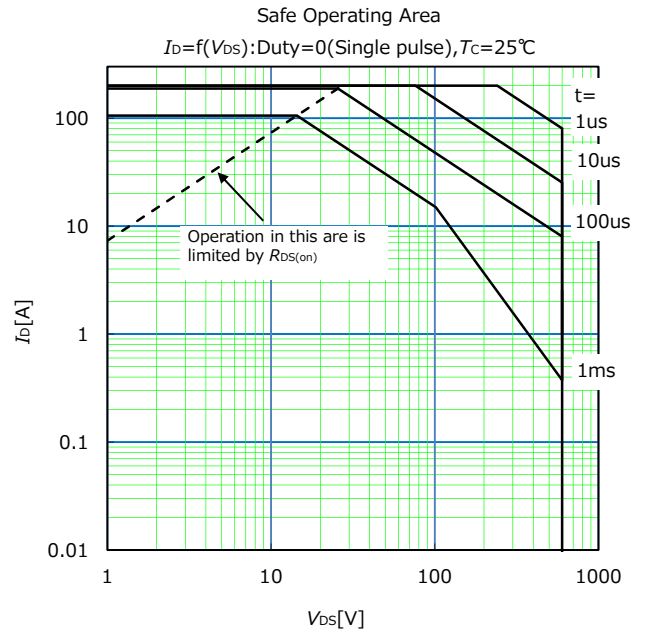
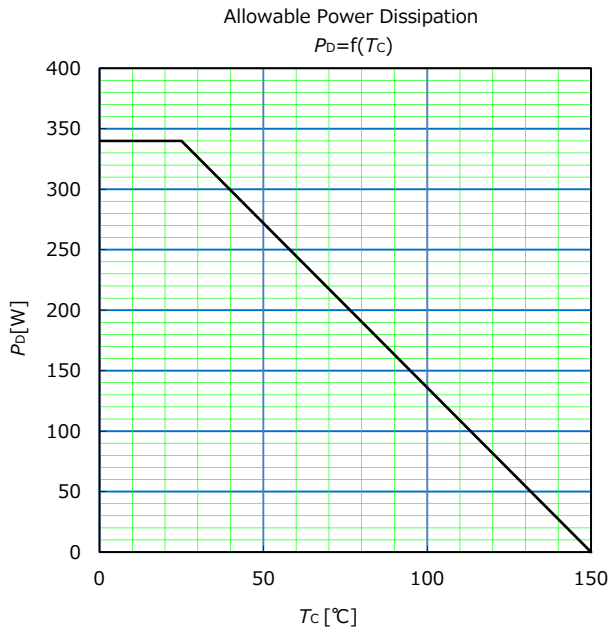

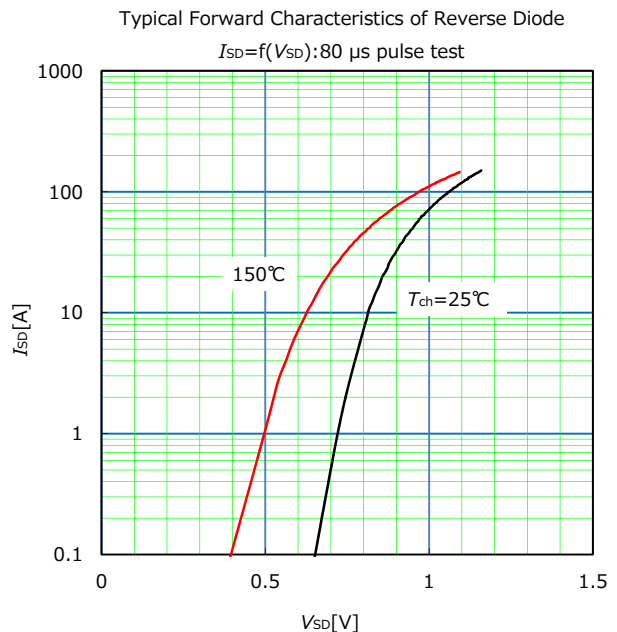
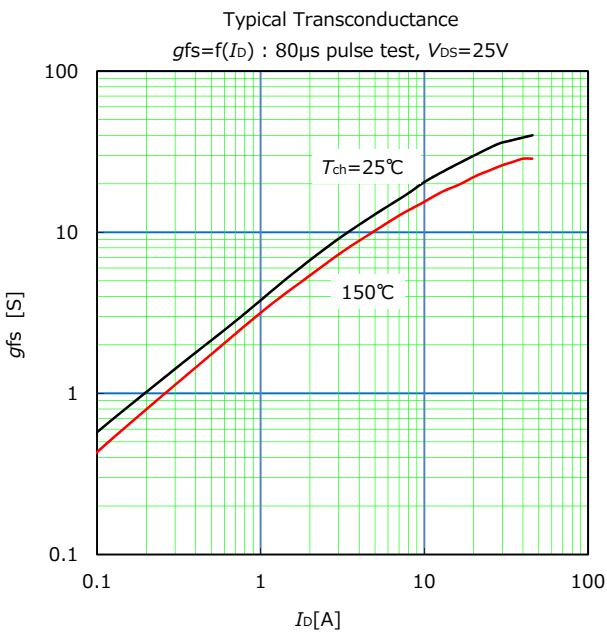
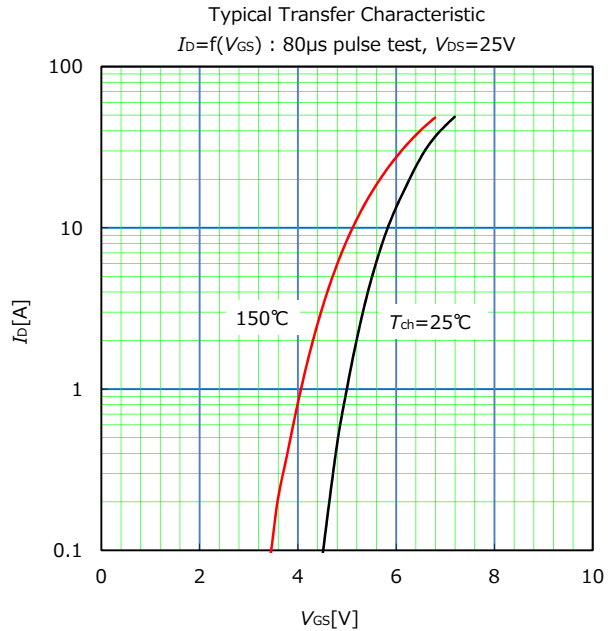
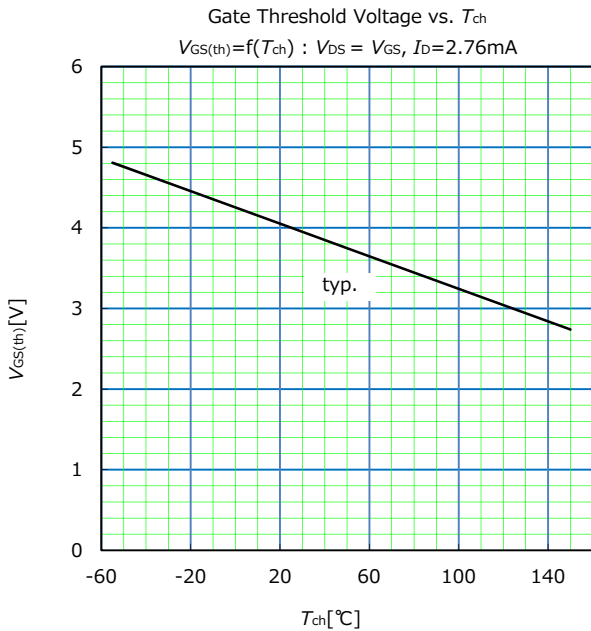
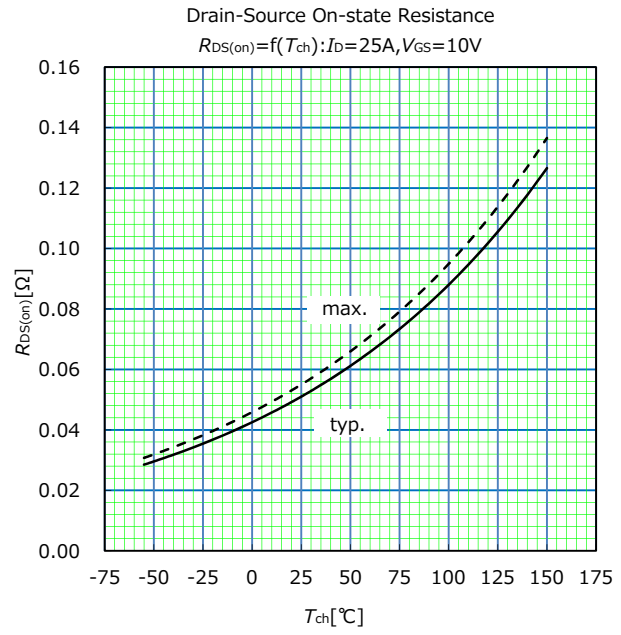
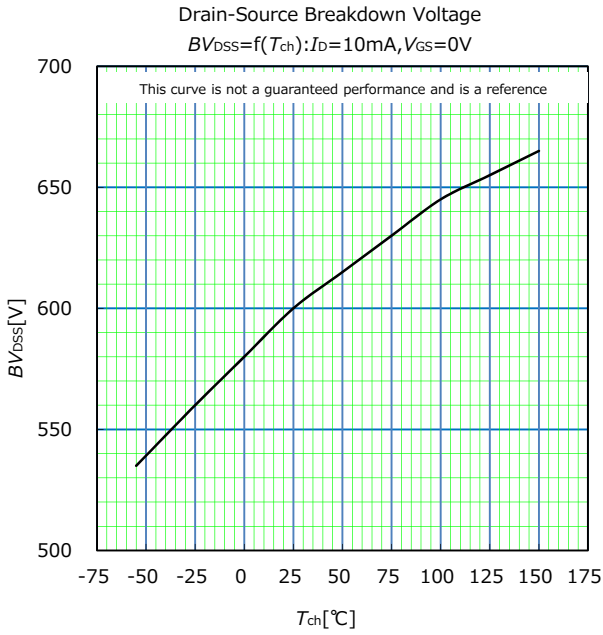

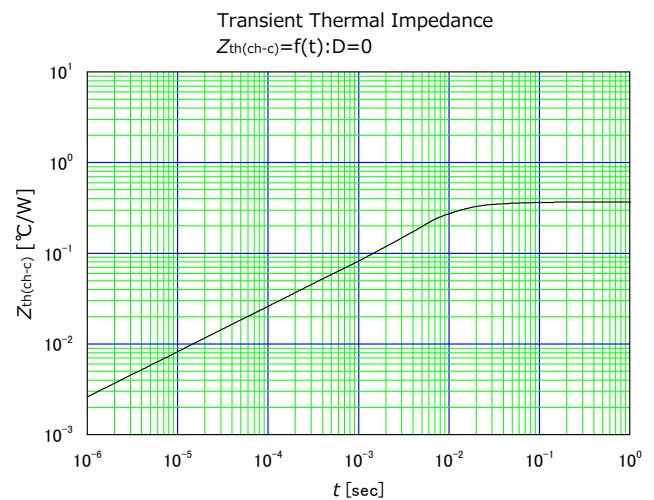
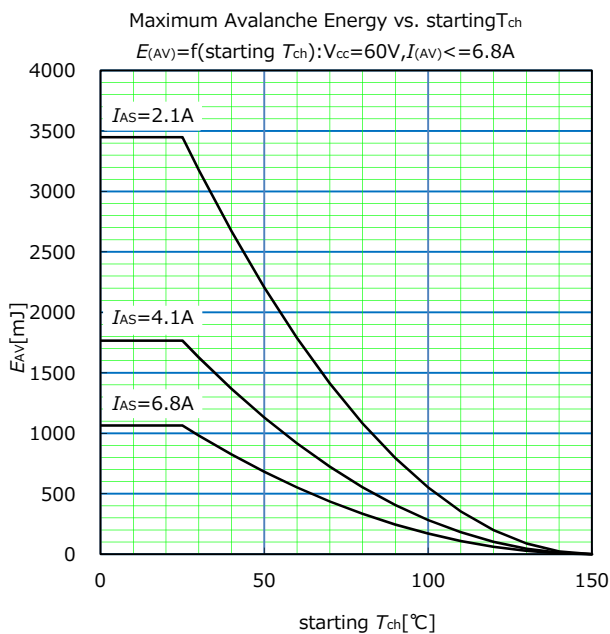
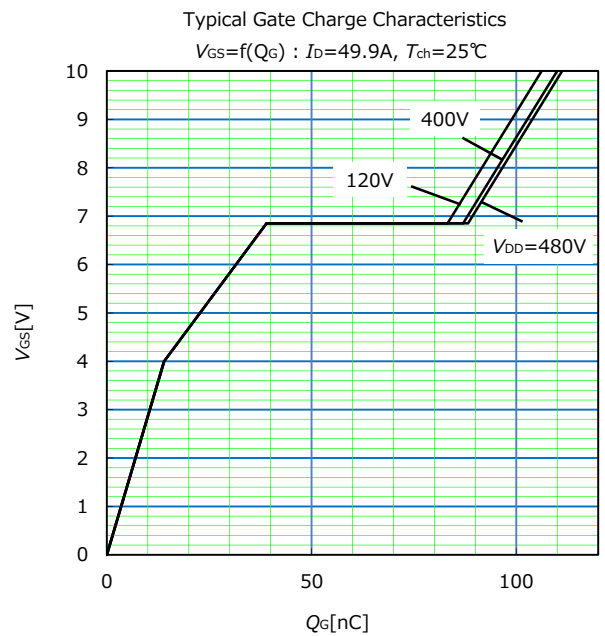
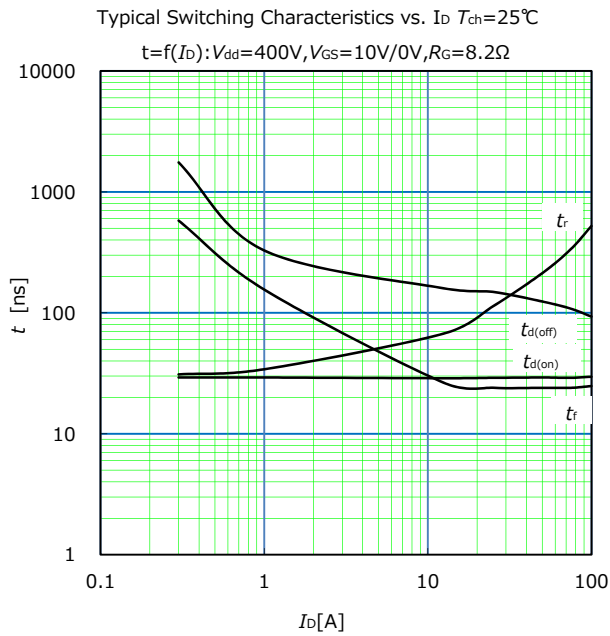
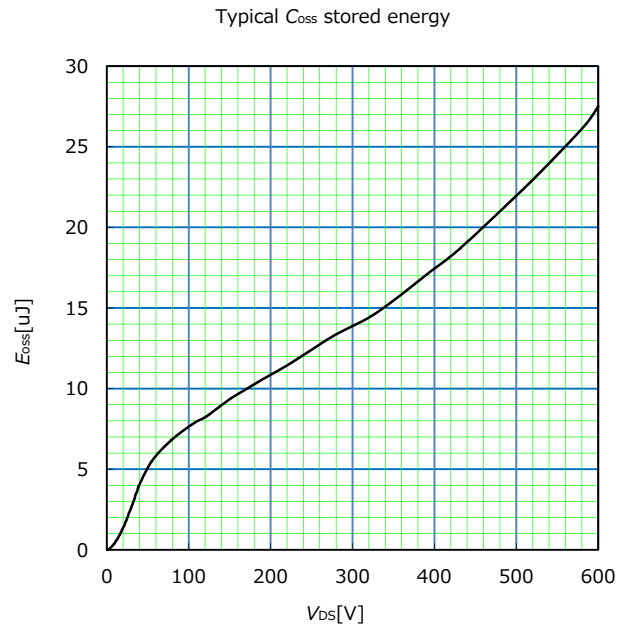
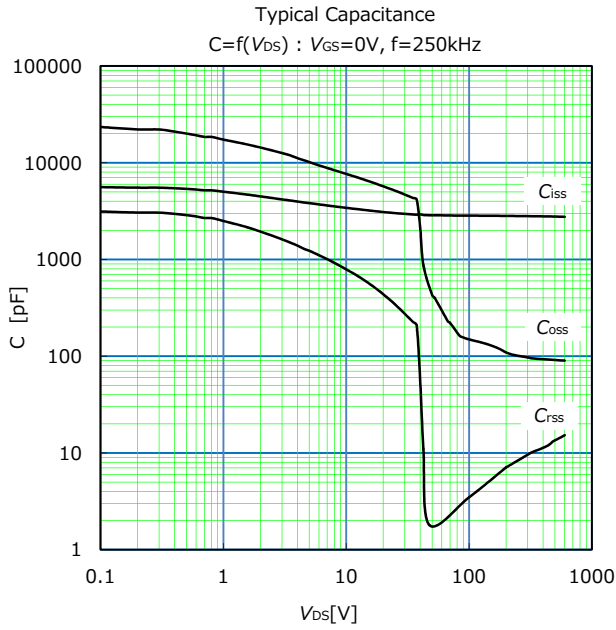

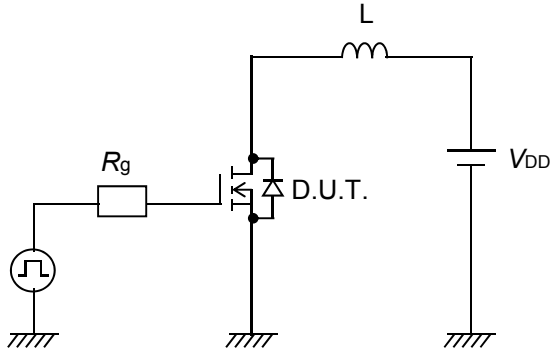

Fig.1 Avalanche Test circuit

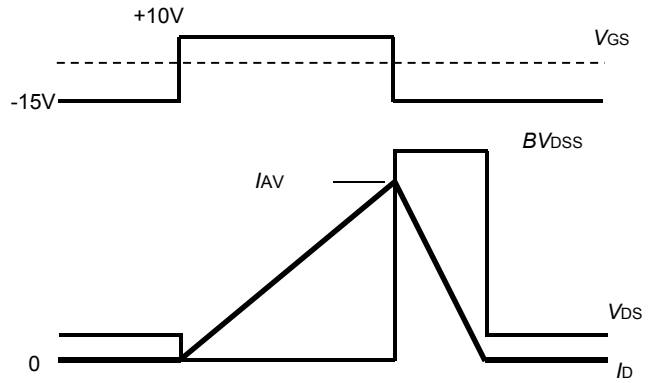

Fig.2 Operating waveforms of Avalanche Test

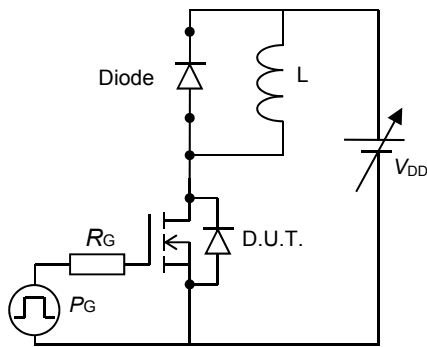

Fig.3 Switching Test circuit

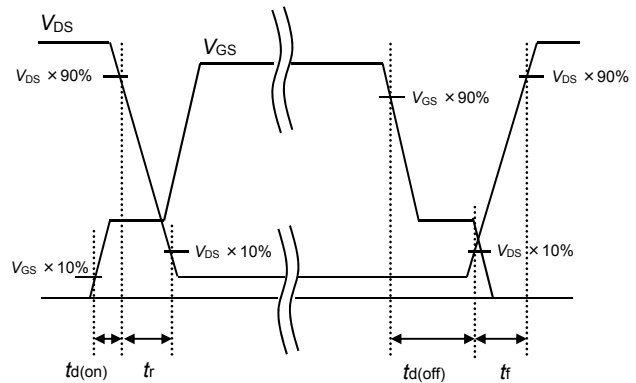

Fig.4 Operating waveform of Switching Test

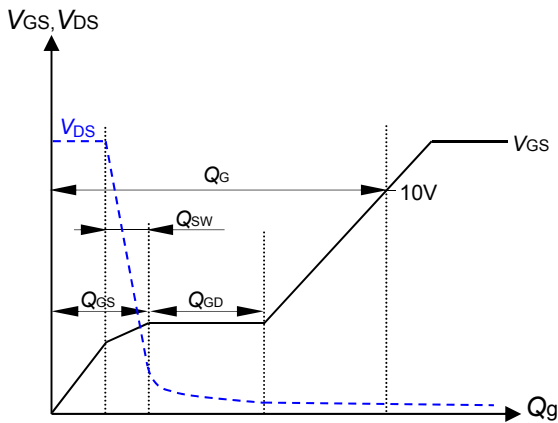

Fig.5 Operating waveform of Gate charge Test

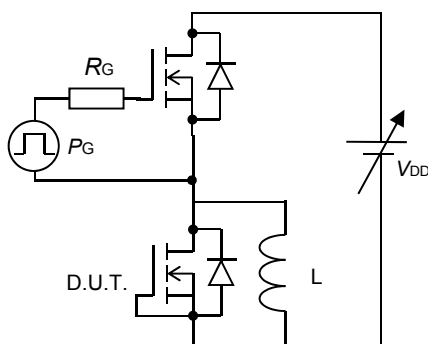

Fig.6 Reverse recovery Test circuit

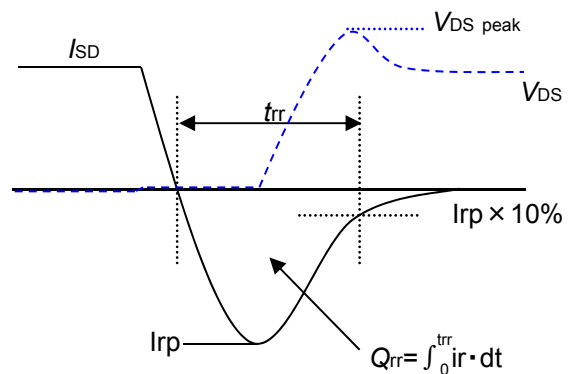
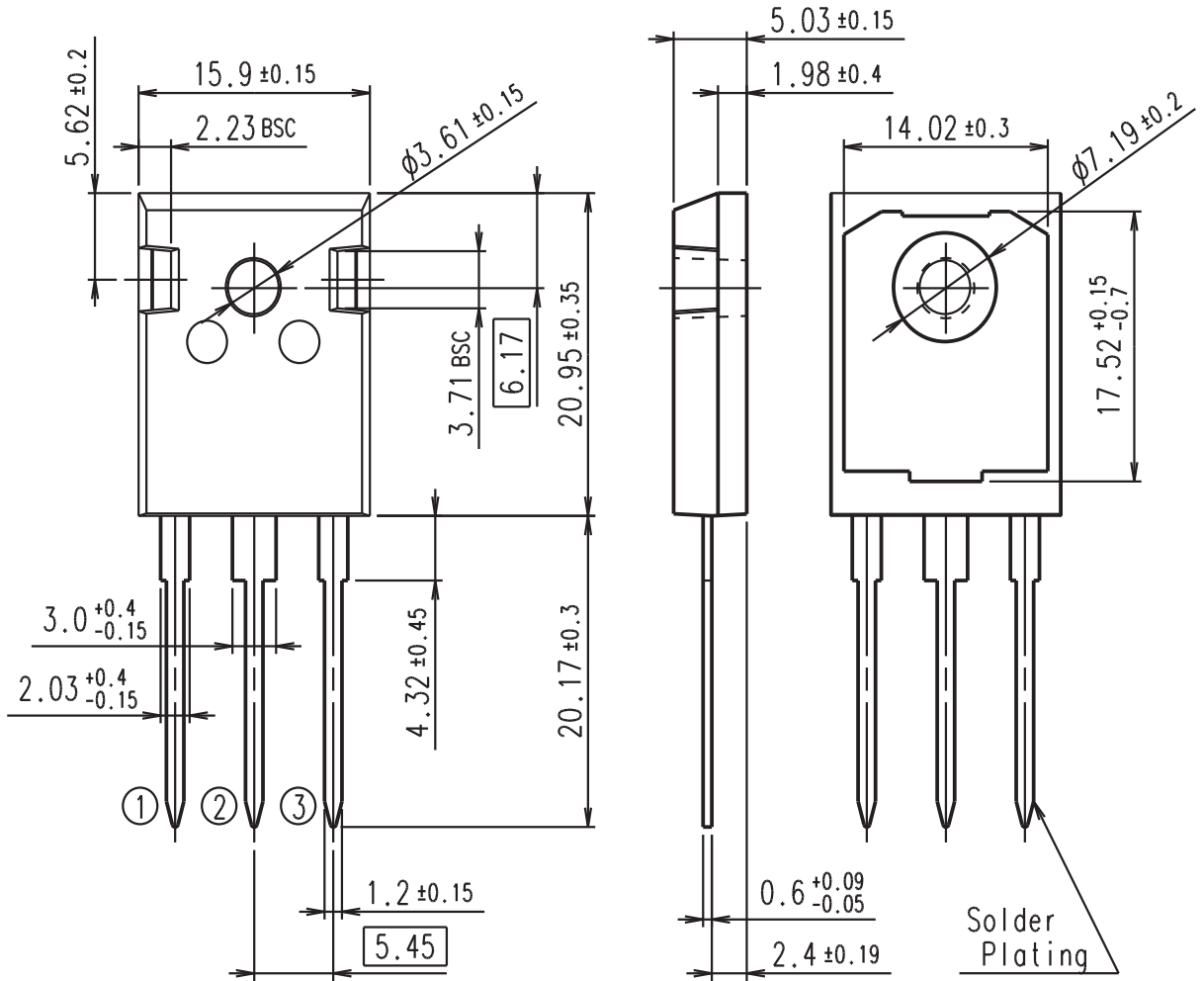
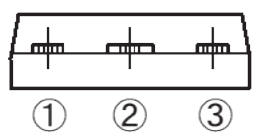

Fig.7 Operating waveform of Reverse recovery Test

■ Outview: TO-247-P/TO-247-P2 Package



Solder Plating



CONNECTION

- ① GATE
- ② COLLECTOR
- ③ EMITTER

DIMENSIONS ARE IN MILLIMETERS.

■ Marking

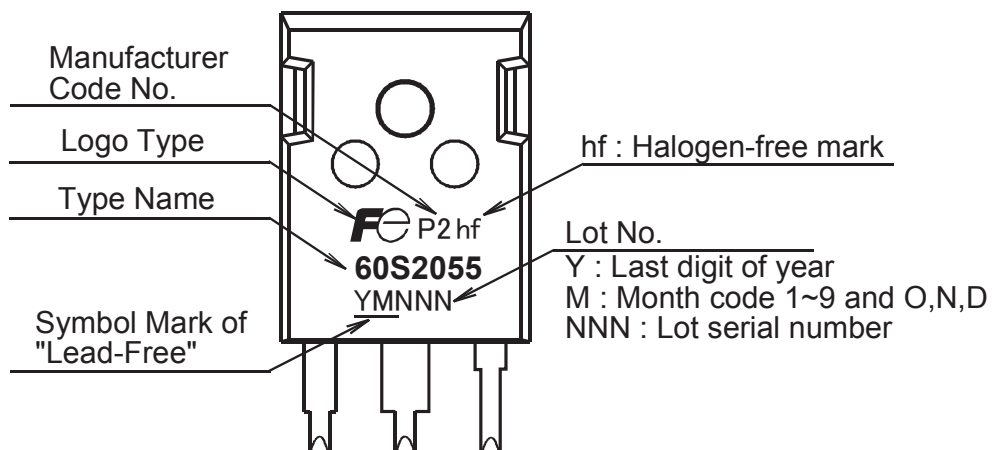

\* The font (font type,size) and the logo type size might be actually different.

**WARNING**

1. This Catalog contains the product specifications, characteristics, data, materials, and structures as of March 2017. The contents are subject to change without notice for specification changes or other reasons. When using a product listed in this Catalog, be sure to obtain the latest specifications.
2. All applications described in this Catalog exemplify the use of Fuji's products for your reference only. No right or license, either express or implied, under any patent, copyright, trade secret or other intellectual property right owned by Fuji Electric Co., Ltd. is (or shall be deemed) granted. Fuji Electric Co., Ltd. makes no representation or warranty, whether express or implied, relating to the infringement or alleged infringement of other's intellectual property rights which may arise from the use of the applications described herein.
3. Although Fuji Electric Co., Ltd. is enhancing product quality and reliability, a small percentage of semiconductor products may become faulty. When using Fuji Electric semiconductor products in your equipment, you are requested to take adequate safety measures to prevent the equipment from causing a physical injury, fire, or other problem if any of the products become faulty. It is recommended to make your design failsafe, flame retardant, and free of malfunction.
4. The products introduced in this Catalog are intended for use in the following electronic and electrical equipment which has normal reliability requirements.
  - Computers
  - OA equipment
  - Communications equipment (terminal devices)
  - Measurement equipment
  - Machine tools
  - Audiovisual equipment
  - Electrical home appliances
  - Personal equipment
  - Industrial robots etc.
5. If you need to use a product in this Catalog for equipment requiring higher reliability than normal, such as for the equipment listed below, it is imperative to contact Fuji Electric Co., Ltd. to obtain prior approval. When using these products for such equipment, take adequate measures such as a backup system to prevent the equipment from malfunctioning even if a Fuji's product incorporated in the equipment becomes faulty.
  - Transportation equipment (mounted on cars and ships)
  - Trunk communications equipment
  - Traffic-signal control equipment
  - Gas leakage detectors with an auto-shut-off feature
  - Emergency equipment for responding to disasters and anti-burglary devices
  - Safety devices
  - Medical equipment
6. Do not use products in this Catalog for the equipment requiring strict reliability such as the following and equivalents to strategic equipment (without limitation).
  - Space equipment
  - Aeronautic equipment
  - Nuclear control equipment
  - Submarine repeater equipment
7. Copyright ©1996-2017 by Fuji Electric Co., Ltd. All rights reserved.  
No part of this Catalog may be reproduced in any form or by any means without the express permission of Fuji Electric Co., Ltd.
8. If you have any question about any portion in this Catalog, ask Fuji Electric Co., Ltd. or its sales agents before using the product. Neither Fuji Electric Co., Ltd. nor its agents shall be liable for any injury caused by any use of the products not in accordance with instructions set forth herein.