

7MBR10XKA065-50

IGBT Modules

Power Module(X series)
650V / 10A / PIM

■ Features

- Low $V_{CE(sat)}$
- Compact Package
- P.C.Board Mount Module
- Converter Diode Bridge Dynamic Brake Circuit
- RoHS compliant Product

■ Applications

- Inverter for Motor Drive
- AC and DC Servo Drive Amplifier
- Uninterruptible Power Supply

■ Outline drawing (Unit : mm)

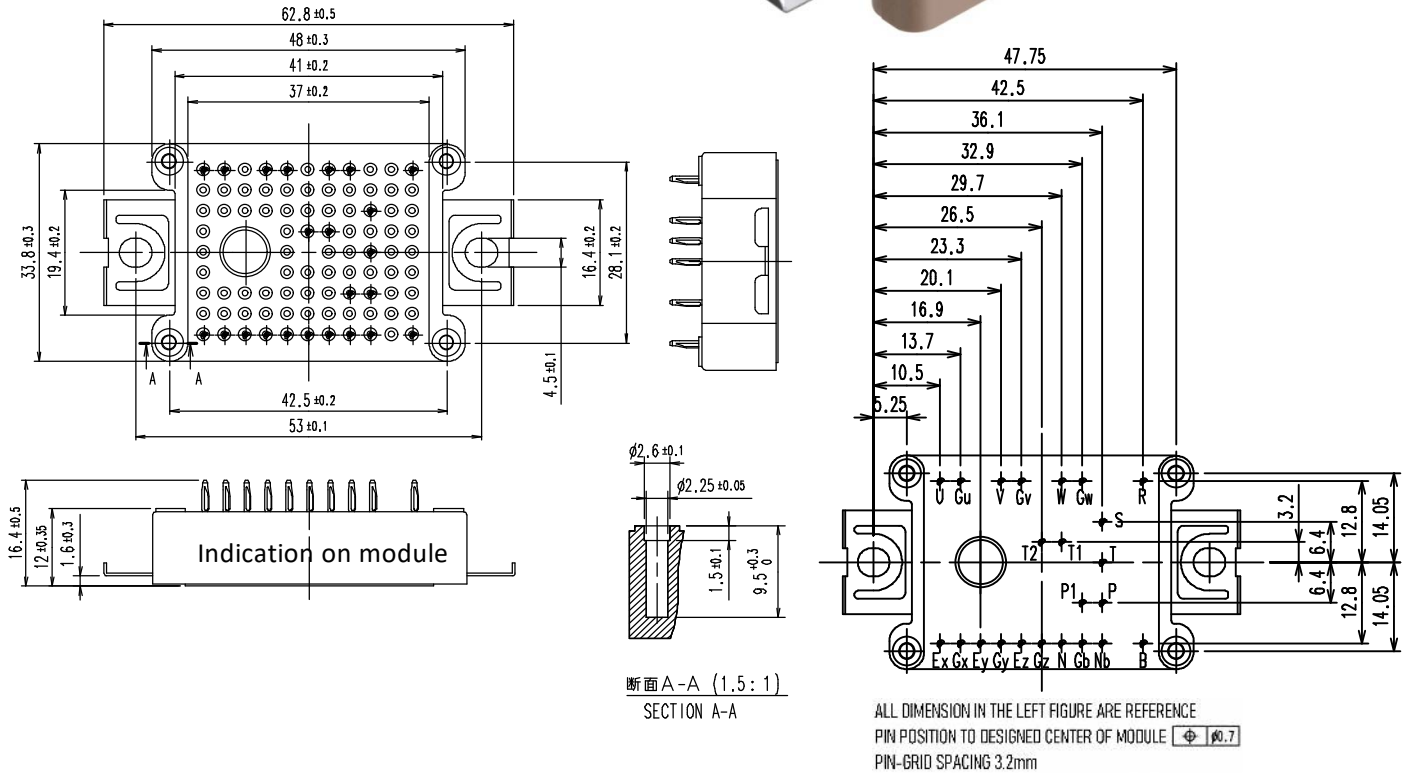

Weight: 25 g (typ.)

■ Typical appearance

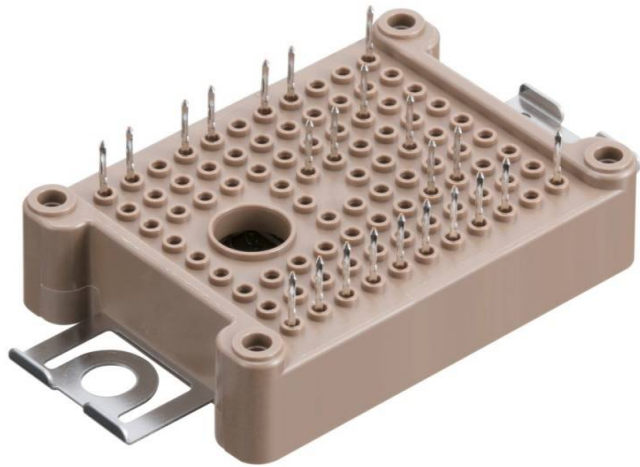

■ Equivalent circuit

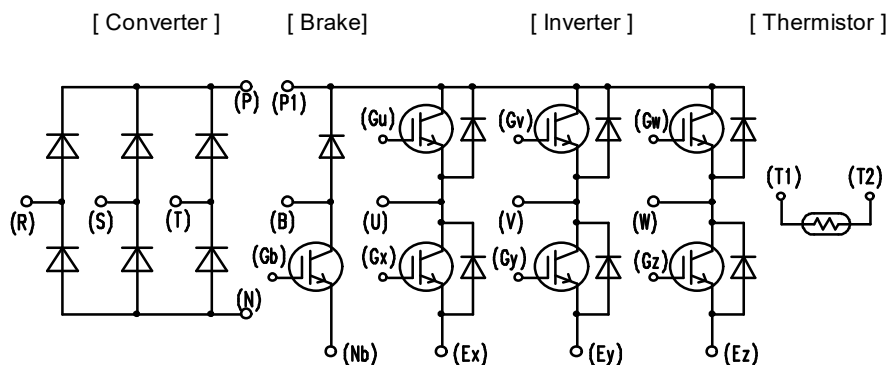

7MBR10XKA065-50

IGBT Modules
■ Maximum ratings (at $T_c = 25^\circ\text{C}$ unless otherwise specified)

| Items | | Symbols | Conditions | | Maximum ratings | Units |
|---|---|------------|---|----------------------------|-----------------|----------------------|
| Inverter | Collector-Emitter voltage, Gate-Emitter short-circuited | V_{CES} | | | 650 | V |
| | Gate-Emitter voltage, Collector-Emitter short-circuited | V_{GES} | | | ± 20 | V |
| | Collector current | I_C | Continuous | $T_c=100^\circ\text{C}$ | 10 | A |
| | Repetitive peak collector current | I_{CRM} | 1ms | | 20 | |
| | Forward current | I_F | Continuous | | 10 | |
| | Repetitive peak forward current | I_{FRM} | 1ms | | 20 | |
| | Total power dissipation | P_{tot} | 1 device | | 90 | W |
| Brake IGBT | Collector-Emitter voltage, Gate-Emitter short-circuited | V_{CES} | | | 650 | V |
| | Gate-Emitter voltage, Collector-Emitter short-circuited | V_{GES} | | | ± 20 | V |
| | Collector current | I_C | Continuous | $T_c=100^\circ\text{C}$ | 10 | A |
| | Repetitive peak collector current | I_{CRM} | 1ms | | 20 | |
| Total power dissipation | P_{tot} | 1 device | | 90 | W | |
| Brake FWD | Forward current | I_F | Continuous | | 10 | A |
| | Repetitive peak forward current | I_{FRM} | 1ms | | 20 | |
| | Repetitive peak reverse voltage | V_{RRM} | | | 650 | V |
| Converter | Repetitive peak reverse voltage | V_{RRM} | | | 800 | V |
| | Average output current | I_O | Three-phase full wave rectified current | $T_c=80^\circ\text{C}$ | 10 | A |
| | Surge forward current (Non-Repetitive) (*1) | I_{FSM} | $t=10\text{ms}$, Half sine wave form | $T_{vj}=25^\circ\text{C}$ | 390 | A |
| | | | | $T_{vj}=150^\circ\text{C}$ | 340 | |
| | I^2t (Non-Repetitive) (*1) | I^2t | | $T_{vj}=25^\circ\text{C}$ | 760 | A^2s |
| | | | $T_{vj}=150^\circ\text{C}$ | 585 | | |
| Virtual junction temperature | | T_{vj} | Inverter, Brake | | 175 | $^\circ\text{C}$ |
| | | | Converter | | 150 | |
| Operating virtual junction temperature (under switching conditions) | | T_{vjop} | Inverter, Brake | | 175 | |
| | | | Converter | | 150 | |
| Case temperature | | T_c | | | 125 | |
| Storage temperature | | T_{stg} | | | -40 ~ 125 | |
| Isolation voltage | between terminals and copper base (*2) | V_{isol} | A.C. : 1min. | | 2500 | Vrms |
| | between thermistor and others (*3) | | | | | |
| Screw torque | Mounting torque of screws to heat sink | M_s | M4 | | 1.3~1.7 | N·m |

 (*1) T_{vj} : Temperature at test start.

(*2) All terminals should be connected together during the test.

(*3) Two thermistor terminals should be connected together, other terminals should be connected together and shorted to base plate during the test.

7MBR10XKA065-50

IGBT Modules
■ Electrical characteristics (at $T_{vj} = 25^{\circ}\text{C}$ unless otherwise specified)

| Items | Symbols | Conditions | Characteristics | | | Units | |
|---|---|---|------------------------------|------|------|---------------|---------------|
| | | | min. | typ. | max. | | |
| Collector-Emitter cut-off current, Gate-Emitter short-circuited | I_{CES} | $V_{GE} = 0\text{V}$ $V_{CE} = 650\text{V}$ | - | - | 50 | μA | |
| Gate leakage current, Collector-Emitter short-circuited | I_{GES} | $V_{CE} = 0\text{V}$ $V_{GE} = +20/-20\text{V}$ | - | - | 100 | nA | |
| Gate-Emitter threshold voltage | $V_{GE(th)}$ | $V_{CE} = 20\text{V}$ $I_C = 10\text{mA}$ | 6.0 | 6.5 | 7.0 | V | |
| Collector-Emitter saturation voltage | $V_{CE(sat)}$ (terminal) | $V_{GE} = 15\text{V}$ $I_C = 10\text{A}$ | $T_{vj}=25^{\circ}\text{C}$ | - | 1.40 | 1.90 | V |
| | | | $T_{vj}=25^{\circ}\text{C}$ | - | 1.30 | 1.75 | |
| | $T_{vj}=125^{\circ}\text{C}$ | | - | 1.45 | - | | |
| | $T_{vj}=150^{\circ}\text{C}$ | | - | 1.50 | - | | |
| | $V_{CE(sat)}$ (chip) | | $T_{vj}=175^{\circ}\text{C}$ | - | 1.55 | - | |
| Internal gate resistance | r_g | - | - | 0 | - | Ω | |
| Capacitance | C_{ies} | $V_{CE} = 10\text{V}, V_{GE} = 0\text{V}, f = 1\text{MHz}$ | - | 1.1 | - | nF | |
| | C_{oes} | | - | 0.04 | - | | |
| | C_{res} | | - | 0.02 | - | | |
| Gate charge | Q_G | $V_{CC} = 300\text{V}$ $V_{GE} = -15 \rightarrow +15\text{V}$ $I_C = 10\text{A}$ | - | 81 | - | nC | |
| Forward voltage | V_F (terminal) | $I_F = 10\text{A}$ | $T_{vj}=25^{\circ}\text{C}$ | - | 1.65 | 2.15 | V |
| | | | $T_{vj}=25^{\circ}\text{C}$ | - | 1.55 | 2.00 | |
| | $T_{vj}=125^{\circ}\text{C}$ | | - | 1.50 | - | | |
| | $T_{vj}=150^{\circ}\text{C}$ | | - | 1.50 | - | | |
| | $T_{vj}=175^{\circ}\text{C}$ | | - | 1.45 | - | | |
| | V_F (chip) | | | | | | |
| Switching time (*1) | $t_{d(on)}$ | $V_{CC} = 300\text{V}$ $I_C, I_F = 10\text{A}$ $L_s = 30\text{nH}$ $V_{GE} = +15/-15\text{V}$ $R_G = 30\ \Omega$ | $T_{vj}=25^{\circ}\text{C}$ | - | 0.04 | - | μs |
| | | | $T_{vj}=125^{\circ}\text{C}$ | - | 0.04 | - | |
| | | | $T_{vj}=150^{\circ}\text{C}$ | - | 0.04 | - | |
| | | | $T_{vj}=175^{\circ}\text{C}$ | - | 0.04 | - | |
| | t_r | $V_{CC} = 300\text{V}$ $I_C, I_F = 10\text{A}$ $L_s = 30\text{nH}$ $V_{GE} = +15/-15\text{V}$ $R_G = 30\ \Omega$ | $T_{vj}=25^{\circ}\text{C}$ | - | 0.02 | - | |
| | | | $T_{vj}=125^{\circ}\text{C}$ | - | 0.02 | - | |
| | | | $T_{vj}=150^{\circ}\text{C}$ | - | 0.02 | - | |
| | | | $T_{vj}=175^{\circ}\text{C}$ | - | 0.02 | - | |
| | $t_{d(off)}$ | $V_{CC} = 300\text{V}$ $I_C, I_F = 10\text{A}$ $L_s = 30\text{nH}$ $V_{GE} = +15/-15\text{V}$ $R_G = 30\ \Omega$ | $T_{vj}=25^{\circ}\text{C}$ | - | 0.14 | - | |
| | | | $T_{vj}=125^{\circ}\text{C}$ | - | 0.17 | - | |
| | | | $T_{vj}=150^{\circ}\text{C}$ | - | 0.17 | - | |
| | | | $T_{vj}=175^{\circ}\text{C}$ | - | 0.17 | - | |
| t_f | $V_{CC} = 300\text{V}$ $I_C, I_F = 10\text{A}$ $L_s = 30\text{nH}$ $V_{GE} = +15/-15\text{V}$ $R_G = 30\ \Omega$ | $T_{vj}=25^{\circ}\text{C}$ | - | 0.04 | - | | |
| | | $T_{vj}=125^{\circ}\text{C}$ | - | 0.05 | - | | |
| | | $T_{vj}=150^{\circ}\text{C}$ | - | 0.05 | - | | |
| | | $T_{vj}=175^{\circ}\text{C}$ | - | 0.05 | - | | |
| Reverse recovery time | t_{rr} | $V_{CC} = 300\text{V}$ $I_C, I_F = 10\text{A}$ $L_s = 30\text{nH}$ $V_{GE} = +15/-15\text{V}$ $R_G = 30\ \Omega$ | $T_{vj}=25^{\circ}\text{C}$ | - | 0.04 | - | |
| | | | $T_{vj}=125^{\circ}\text{C}$ | - | 0.08 | - | |
| | | | $T_{vj}=150^{\circ}\text{C}$ | - | 0.10 | - | |
| | | | $T_{vj}=175^{\circ}\text{C}$ | - | 0.11 | - | |

(*1) Turn on time (t_{on}) = $t_{d(on)} + t_r$, Turn off time (t_{off}) = $t_{d(off)} + t_f$

7MBR10XKA065-50

| Items | Symbols | Conditions | Characteristics | | | Units | |
|---|--------------------------|--|------------------------|------|------|----------|---------|
| | | | min. | typ. | max. | | |
| Inverter Switching loss (per pulse) | E_{on} | $V_{CC} = 300V$ $I_C, I_F = 10A \quad L_s = 30nH$ $V_{GE} = +15/-15V$ $R_G = 30 \Omega$ | $T_{vj} = 25^\circ C$ | - | 0.15 | - | mJ |
| | | | $T_{vj} = 125^\circ C$ | - | 0.23 | - | |
| | | | $T_{vj} = 150^\circ C$ | - | 0.25 | - | |
| | | | $T_{vj} = 175^\circ C$ | - | 0.29 | - | |
| | E_{off} | $V_{CC} = 300V$ $I_C, I_F = 10A \quad L_s = 30nH$ $V_{GE} = +15/-15V$ $R_G = 30 \Omega$ | $T_{vj} = 25^\circ C$ | - | 0.30 | - | |
| | | | $T_{vj} = 125^\circ C$ | - | 0.38 | - | |
| | | | $T_{vj} = 150^\circ C$ | - | 0.40 | - | |
| | | | $T_{vj} = 175^\circ C$ | - | 0.43 | - | |
| | E_{rr} | $V_{CC} = 300V$ $I_C, I_F = 10A \quad L_s = 30nH$ $V_{GE} = +15/-15V$ $R_G = 30 \Omega$ | $T_{vj} = 25^\circ C$ | - | 0.08 | - | |
| | | | $T_{vj} = 125^\circ C$ | - | 0.14 | - | |
| | | | $T_{vj} = 150^\circ C$ | - | 0.16 | - | |
| | | | $T_{vj} = 175^\circ C$ | - | 0.19 | - | |
| Collector-Emitter cut-off current, Gate-Emitter short-circuited | I_{CES} | $V_{GE} = 0V$ $V_{CE} = 650V$ | - | - | 50 | μA | |
| Gate leakage current, Collector-Emitter short-circuited | I_{GES} | $V_{CE} = 0V, \quad V_{GE} = +20/-20V$ | - | - | 100 | nA | |
| Collector-Emitter saturation voltage | $V_{CE(sat)}$ (terminal) | $V_{GE} = 15V$ $I_C = 10A$ | $T_{vj} = 25^\circ C$ | - | 1.40 | 1.90 | V |
| | | | $T_{vj} = 25^\circ C$ | - | 1.30 | 1.75 | |
| | $T_{vj} = 125^\circ C$ | | - | 1.45 | - | | |
| | $T_{vj} = 150^\circ C$ | | - | 1.50 | - | | |
| $V_{CE(sat)}$ (chip) | $T_{vj} = 175^\circ C$ | - | - | 1.55 | - | | |
| | | - | - | - | - | | |
| | | - | - | - | - | | |
| | | - | - | - | - | | |
| Internal gate resistance | r_g | - | - | 0 | - | Ω | |
| Brake Switching time (*1) | $t_{d(on)}$ | $V_{CC} = 300V$ $I_C = 10A \quad L_s = 30nH$ $V_{GE} = +15/-15V$ $R_G = 30 \Omega$ | $T_{vj} = 25^\circ C$ | - | 0.04 | - | μs |
| | | | $T_{vj} = 125^\circ C$ | - | 0.04 | - | |
| | | | $T_{vj} = 150^\circ C$ | - | 0.04 | - | |
| | | | $T_{vj} = 175^\circ C$ | - | 0.04 | - | |
| | t_r | $V_{CC} = 300V$ $I_C = 10A \quad L_s = 30nH$ $V_{GE} = +15/-15V$ $R_G = 30 \Omega$ | $T_{vj} = 25^\circ C$ | - | 0.02 | - | |
| | | | $T_{vj} = 125^\circ C$ | - | 0.02 | - | |
| | | | $T_{vj} = 150^\circ C$ | - | 0.02 | - | |
| | | | $T_{vj} = 175^\circ C$ | - | 0.02 | - | |
| | $t_{d(off)}$ | $V_{CC} = 300V$ $I_C = 10A \quad L_s = 30nH$ $V_{GE} = +15/-15V$ $R_G = 30 \Omega$ | $T_{vj} = 25^\circ C$ | - | 0.14 | - | |
| | | | $T_{vj} = 125^\circ C$ | - | 0.17 | - | |
| | | | $T_{vj} = 150^\circ C$ | - | 0.17 | - | |
| | | | $T_{vj} = 175^\circ C$ | - | 0.17 | - | |
| | t_f | $V_{CC} = 300V$ $I_C = 10A \quad L_s = 30nH$ $V_{GE} = +15/-15V$ $R_G = 30 \Omega$ | $T_{vj} = 25^\circ C$ | - | 0.04 | - | |
| | | | $T_{vj} = 125^\circ C$ | - | 0.05 | - | |
| | | | $T_{vj} = 150^\circ C$ | - | 0.05 | - | |
| | | | $T_{vj} = 175^\circ C$ | - | 0.05 | - | |
| Reverse current | I_{RRM} | $V_R = 650V$ | - | - | 50 | μA | |
| Forward voltage | V_F (terminal) | $I_F = 10A$ | $T_{vj} = 25^\circ C$ | - | 1.65 | 2.15 | V |
| | | | $T_{vj} = 25^\circ C$ | - | 1.55 | 2.00 | |
| | $T_{vj} = 125^\circ C$ | | - | 1.50 | - | | |
| | $T_{vj} = 150^\circ C$ | | - | 1.50 | - | | |
| V_F (chip) | $T_{vj} = 175^\circ C$ | - | - | 1.45 | - | | |
| | | - | - | - | - | | |
| Reverse current | I_{RRM} | $V_R = 800V$ | - | - | 50 | μA | |
| Continuous (direct) forward voltage | V_F | $I_F = 10A$ | terminal | - | 1.00 | 1.50 | V |
| | | | chip | - | 0.90 | 1.35 | |
| Resistance | R | $T = 25^\circ C$ | - | 5000 | - | Ω | |
| | | $T = 100^\circ C$ | 465 | 495 | 520 | | |
| B value | B | $T = 25/50^\circ C$ | 3305 | 3375 | 3450 | K | |

(*1) Turn on time (t_{on}) = $t_{d(on)}$ + t_r , Turn off time (t_{off}) = $t_{d(off)}$ + t_f

7MBR10XKA065-50

NOTICE:

The external gate resistance (R_G) shown above is one of our recommended value for the purpose of minimum switching loss. However the optimum R_G depends on circuit configuration and/or environment. We recommend that the R_G has to be carefully chosen based on consideration if IGBT module matches design criteria, for example, switching loss, EMC/EMI, spike voltage, surge current and no unexpected oscillation and so on.

■ Thermal resistance characteristics

| Items | Symbols | Conditions | Characteristics | | | Units |
|--|---------------|-----------------|-----------------|------|------|-------|
| | | | min. | typ. | max. | |
| Thermal resistance junction to case (1 device) | $R_{th(j-c)}$ | Inverter IGBT | - | - | 1.63 | K/W |
| | | Inverter FWD | - | - | 1.92 | |
| | | Brake IGBT | - | - | 1.63 | |
| | | Brake FWD | - | - | 1.92 | |
| | | Converter Diode | - | - | 0.75 | |
| Thermal resistance case to heat sink(*1) (1 device) | $R_{th(c-s)}$ | Inverter IGBT | - | 0.83 | - | |
| | | Inverter FWD | - | 0.97 | - | |
| | | Brake IGBT | - | 0.87 | - | |
| | | Brake FWD | - | 0.80 | - | |
| | | Converter Diode | - | 0.79 | - | |

(*1) This is the value which is defined mounting on the additional cooling fin with 1 W/(m·K) thermal grease.

7MBR10XKA065-50

IGBT Modules

[Inverter]

Collector current vs. Collector-Emittor voltage (typ.)
 $T_{vj} = 25^{\circ}\text{C} / \text{chip}$

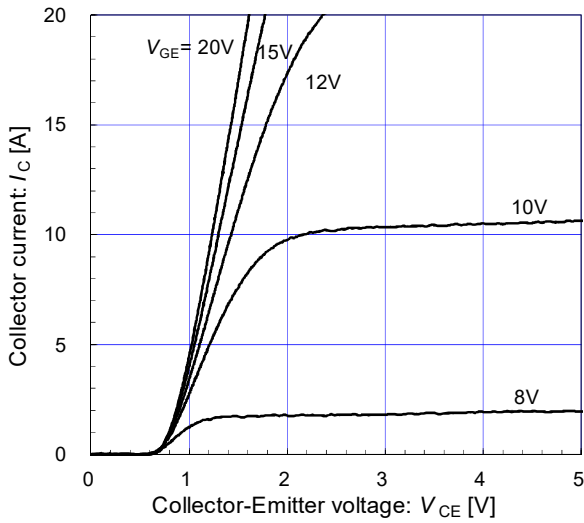

[Inverter]

Collector current vs. Collector-Emittor voltage (typ.)
 $T_{vj} = 175^{\circ}\text{C} / \text{chip}$

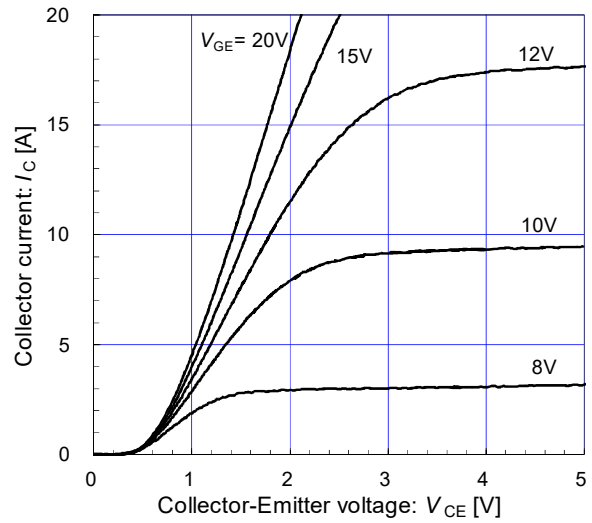

[Inverter]

Collector current vs. Collector-Emittor voltage (typ.)
 $V_{GE} = 15\text{V} / \text{chip}$

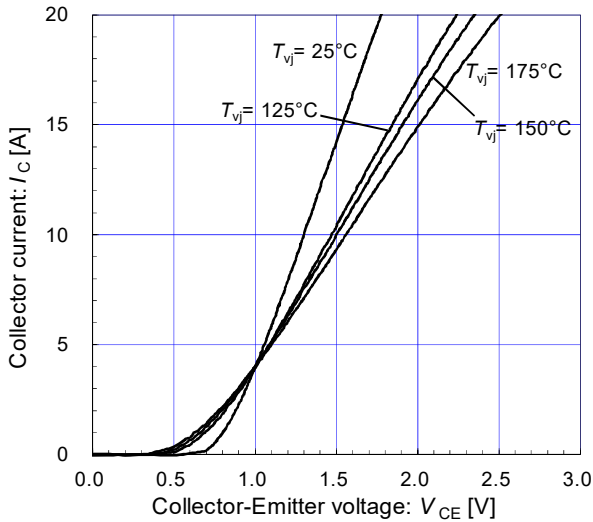

[Inverter]

Collector-Emittor voltage vs. Gate-Emittor voltage (typ.)
 $T_{vj} = 25^{\circ}\text{C} / \text{chip}$

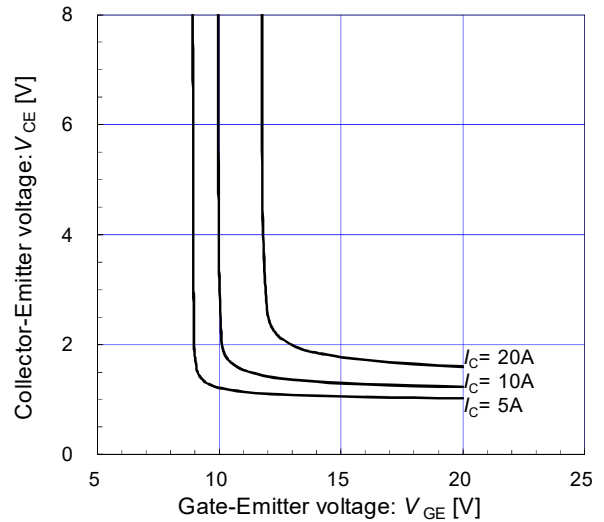

[Inverter]

Capacitance vs. Collector-Emittor voltage (typ.)
 $V_{GE} = 0\text{V}, f = 1\text{MHz}, T_{vj} = 25^{\circ}\text{C}$

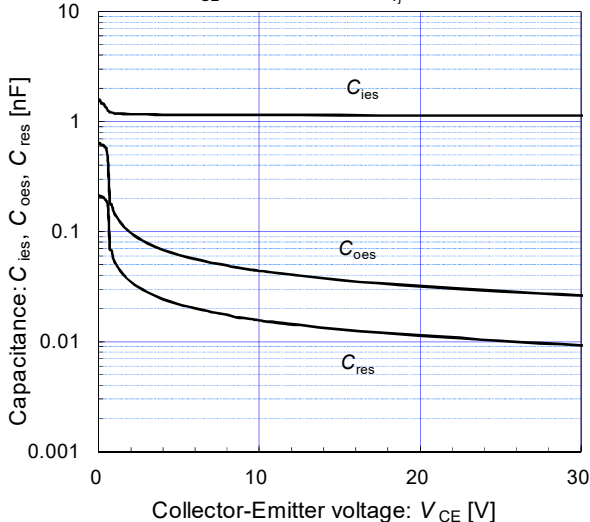

[Inverter]

Dynamic gate charge (typ.)

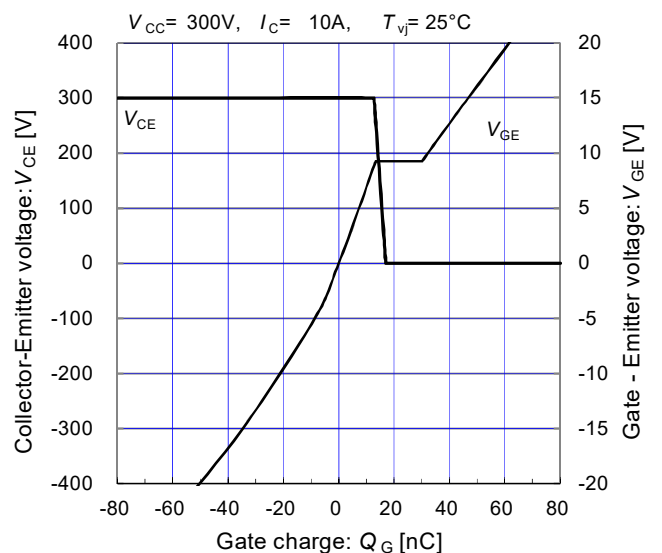

7MBR10XKA065-50

[Inverter]

E_{on} vs. Collector current (typ.)

$V_{CC}=300V, V_{GE}=+15/-15V, R_G=30\Omega$

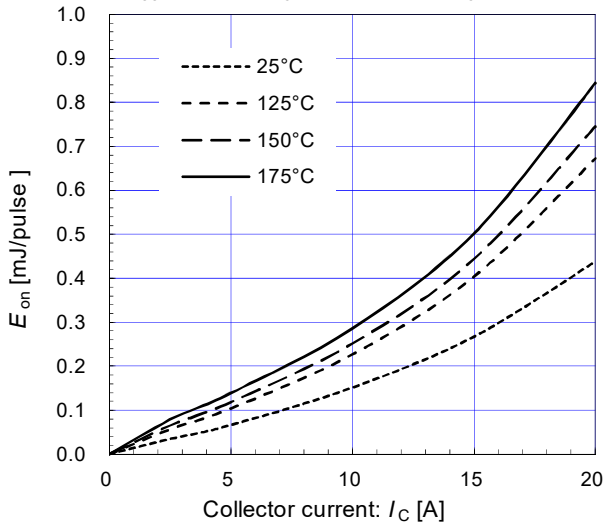

[Inverter]

E_{on} vs. Gate resistance (typ.)

$V_{CC}=300V, V_{GE}=+15/-15V, I_C=10A$

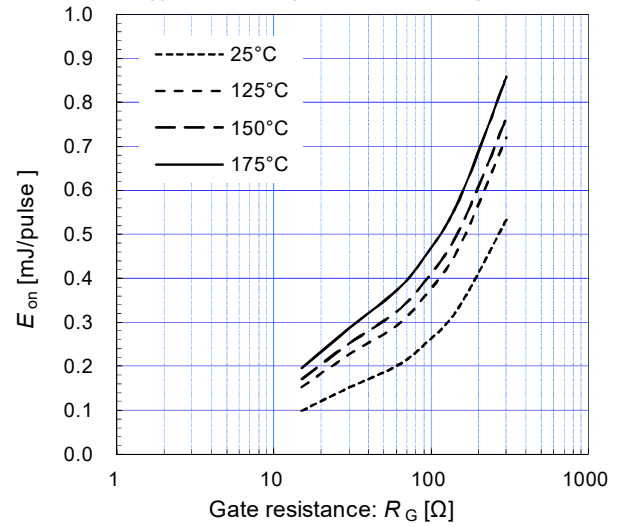

[Inverter]

E_{off} vs. Collector current (typ.)

$V_{CC}=300V, V_{GE}=+15/-15V, R_G=30\Omega$

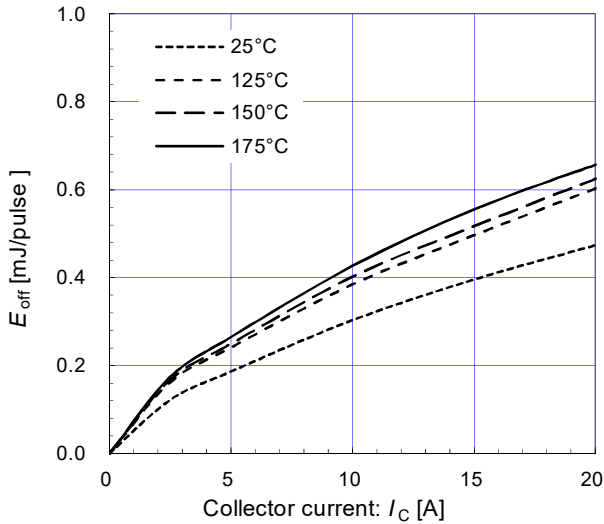

[Inverter]

E_{off} vs. Gate resistance (typ.)

$V_{CC}=300V, V_{GE}=+15/-15V, I_C=10A$

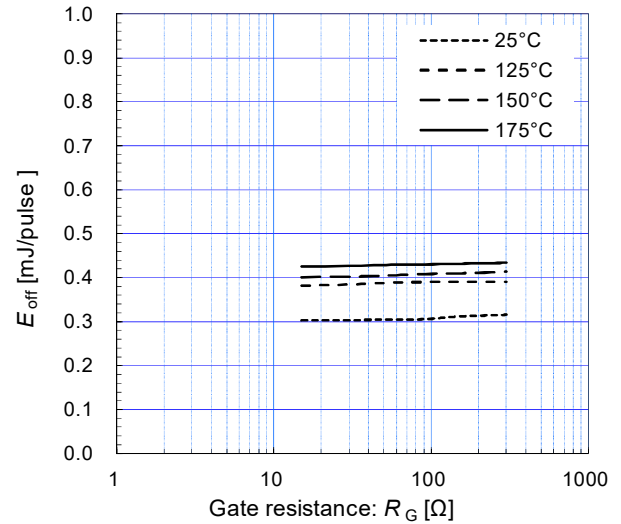

[Inverter]

E_{rr} vs. Forward current (typ.)

$V_{CC}=300V, V_{GE}=+15/-15V, R_G=30\Omega$

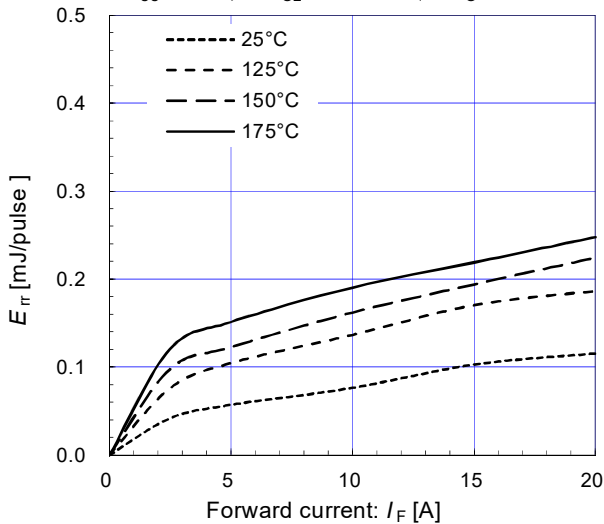

[Inverter]

E_{rr} vs. Gate resistance (typ.)

$V_{CC}=300V, V_{GE}=+15/-15V, I_F=10A$

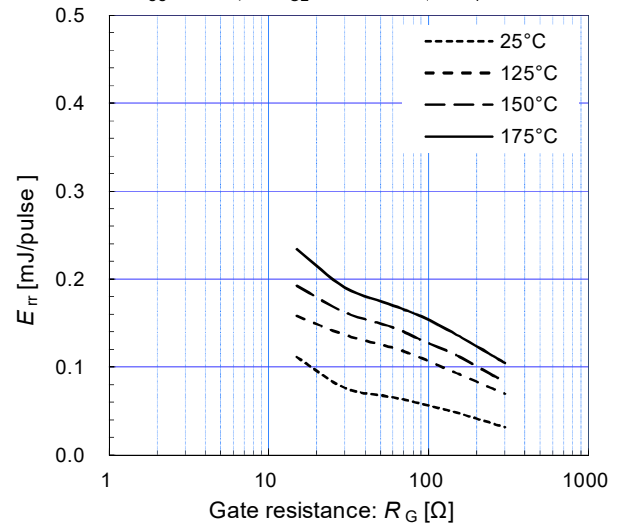

7MBR10XKA065-50

IGBT Modules

[Inverter]

Switching time vs. Collector current (typ.)

$V_{CC}=300V, R_G=30\Omega, V_{GE}=+15/-15V, T_{vj}=25^\circ C$

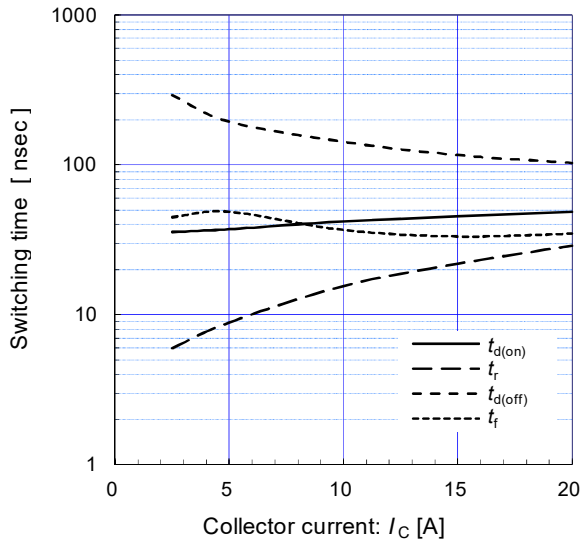

[Inverter]

Switching time vs. Gate resistance (typ.)

$V_{CC}=300V, I_C=10A, V_{GE}=+15/-15V, T_{vj}=25^\circ C$

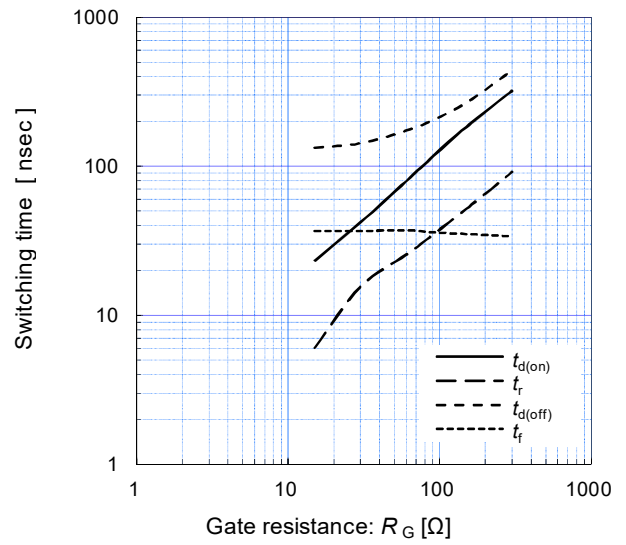

[Inverter]

Switching time vs. Collector current (typ.)

$V_{CC}=300V, R_G=30\Omega, V_{GE}=+15/-15V, T_{vj}=175^\circ C$

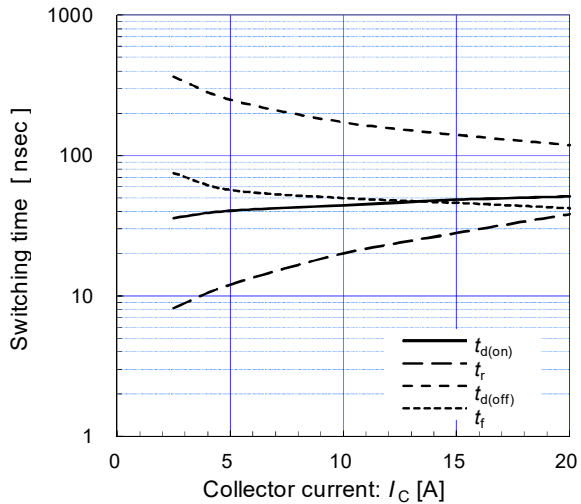

[Inverter]

Switching time vs. Gate resistance (typ.)

$V_{CC}=300V, I_C=10A, V_{GE}=+15/-15V, T_{vj}=175^\circ C$

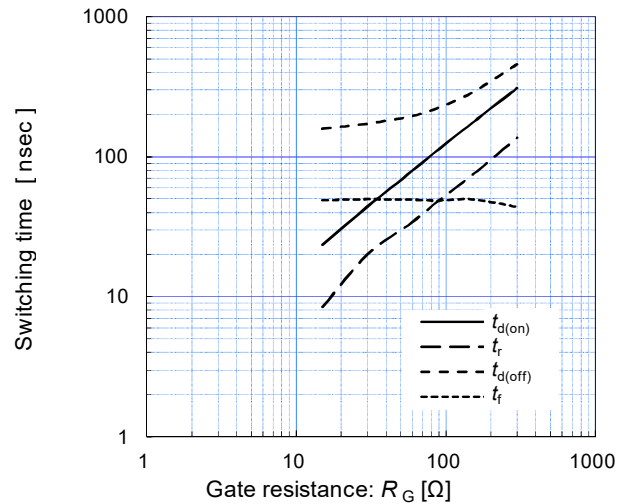

[Inverter]

Reverse bias safe operating area (max.)

$V_{GE}=+15/-15V, R_G \geq 30\Omega, T_{vj}=175^\circ C$

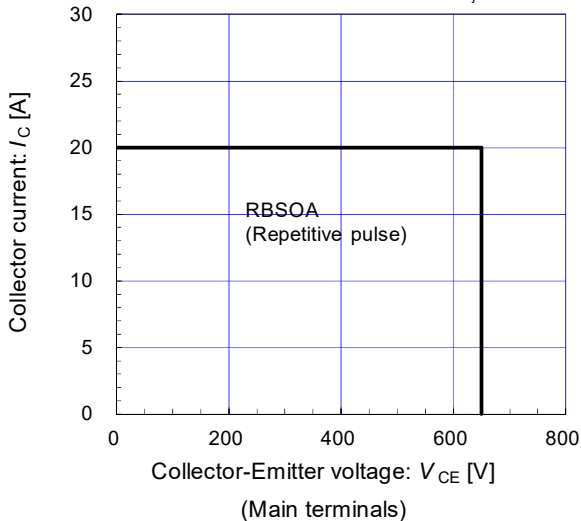

7MBR10XKA065-50

IGBT Modules

[Inverter]

Forward current vs. Forward voltage (typ.)
chip

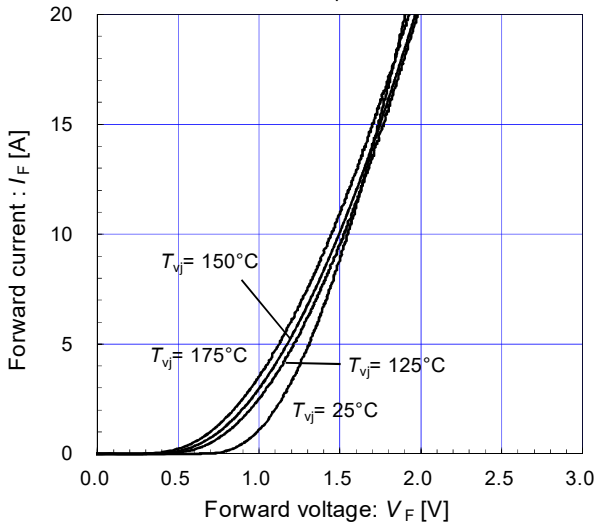

[Inverter]

Reverse recovery characteristics (typ.)

$V_{CC} = 300V, V_{GE} = +15/-15V, R_G = 30\Omega$

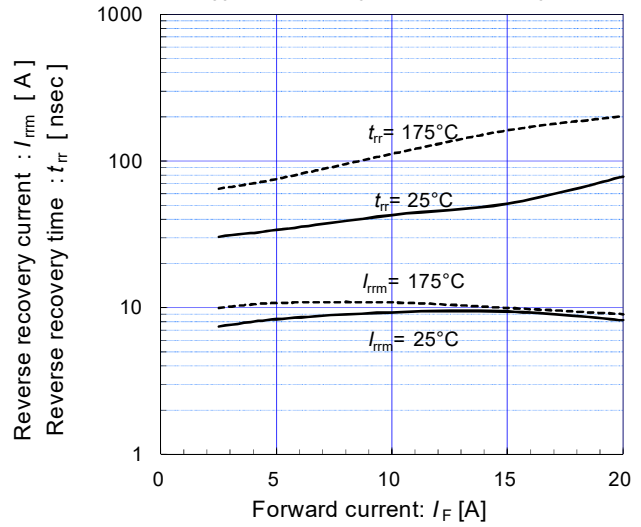

[Converter]

Forward current vs. Forward voltage (typ.)

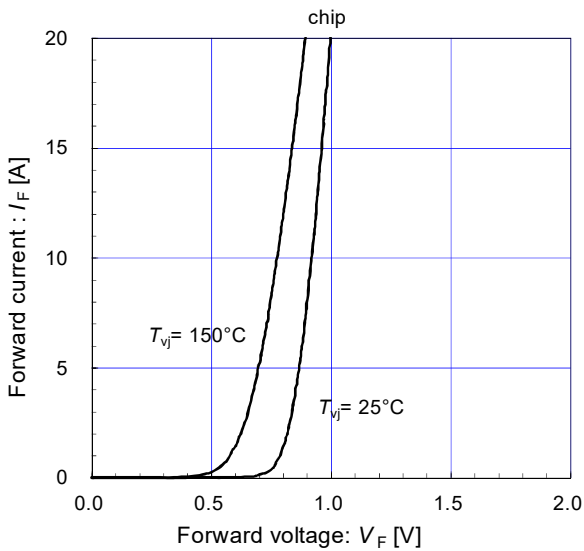

[Thermistor]

Temperature characteristic (typ.)

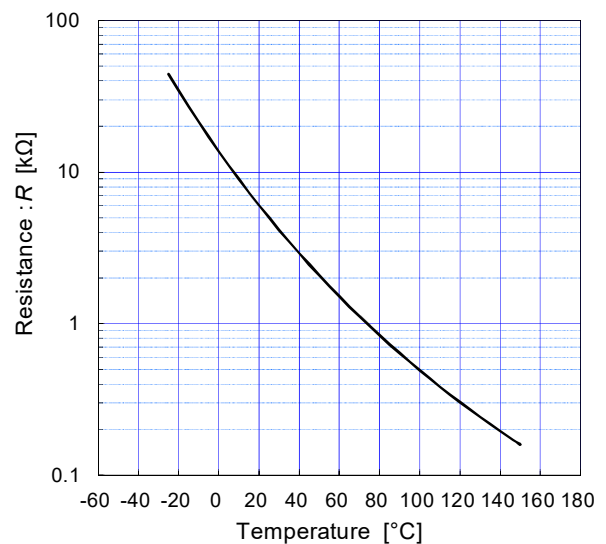

Transient thermal impedance (max.)

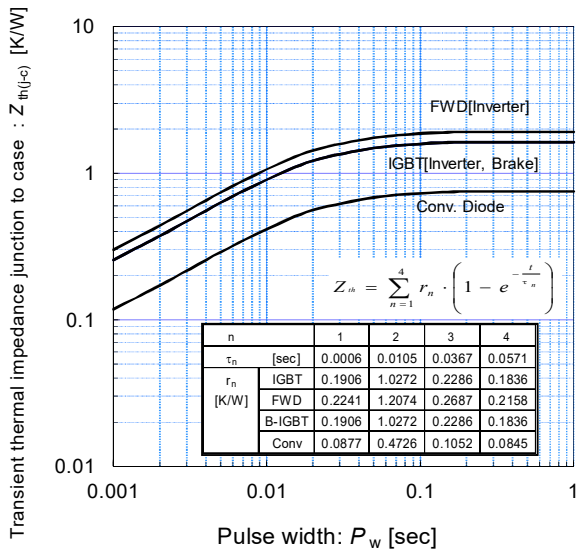

7MBR10XKA065-50

IGBT Modules

[Brake]

Collector current vs. Collector-Emittor voltage (typ.)

$T_{vj} = 25^{\circ}\text{C}$ / chip

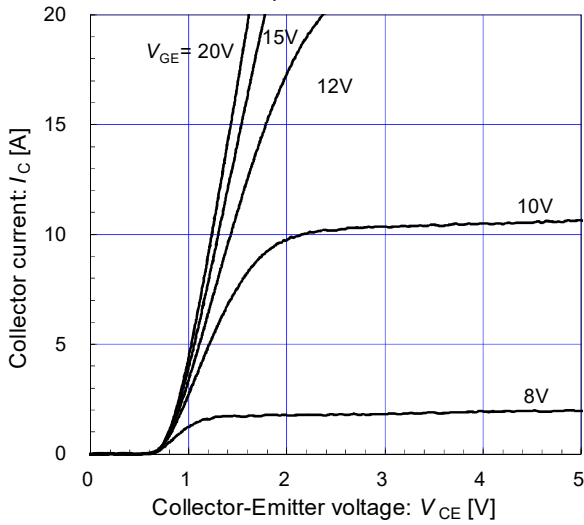

[Brake]

Collector current vs. Collector-Emittor voltage (typ.)

$T_{vj} = 175^{\circ}\text{C}$ / chip

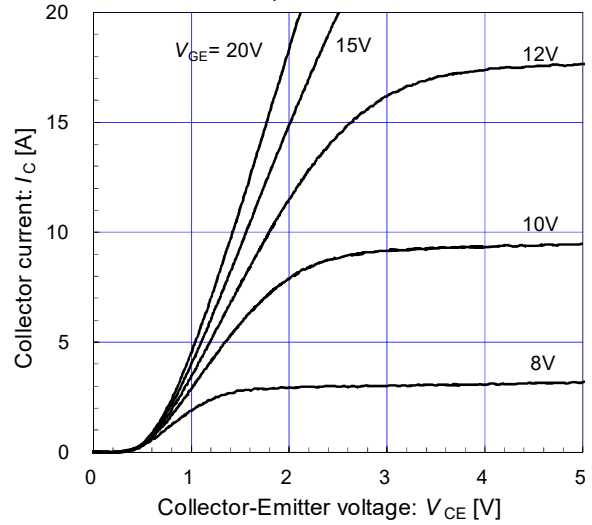

[Brake]

Collector current vs. Collector-Emittor voltage (typ.)

$V_{GE} = 15\text{V}$ / chip

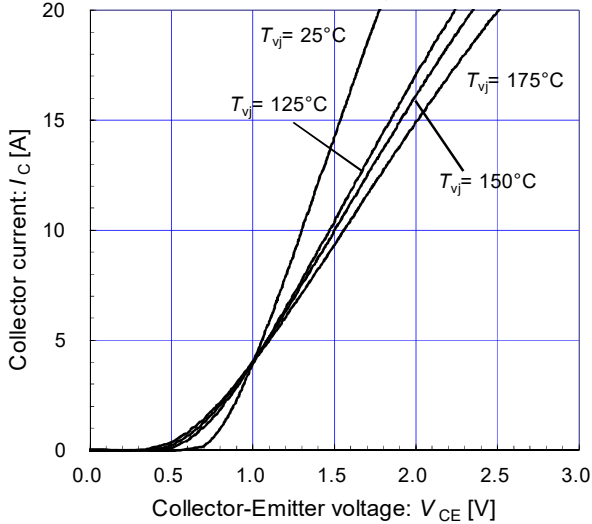

[Brake]

Collector-Emittor voltage vs. Gate-Emittor voltage (typ.)

$T_{vj} = 25^{\circ}\text{C}$ / chip

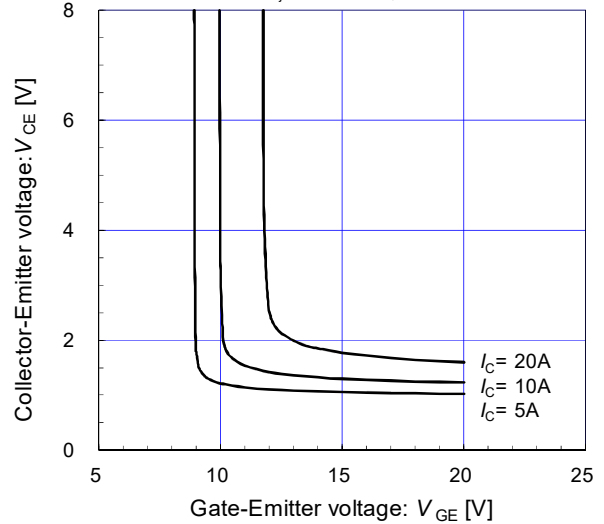

[Brake]

Capacitance vs. Collector-Emittor voltage (typ.)

$V_{GE} = 0\text{V}$, $f = 1\text{MHz}$, $T_{vj} = 25^{\circ}\text{C}$

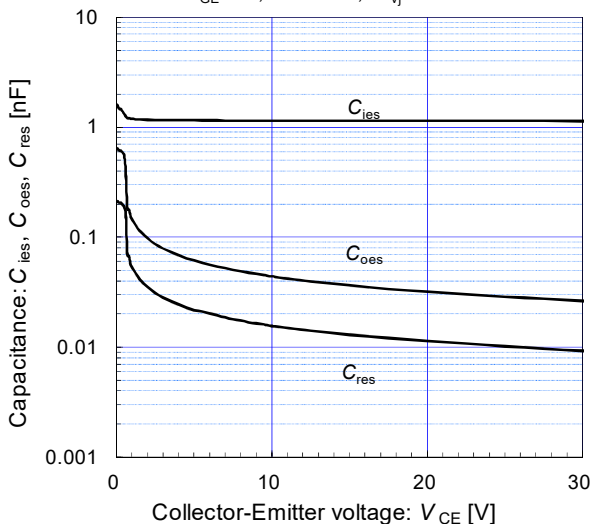

[Brake]

Dynamic gate charge (typ.)

$V_{CC} = 300\text{V}$, $I_C = 10\text{A}$, $T_{vj} = 25^{\circ}\text{C}$

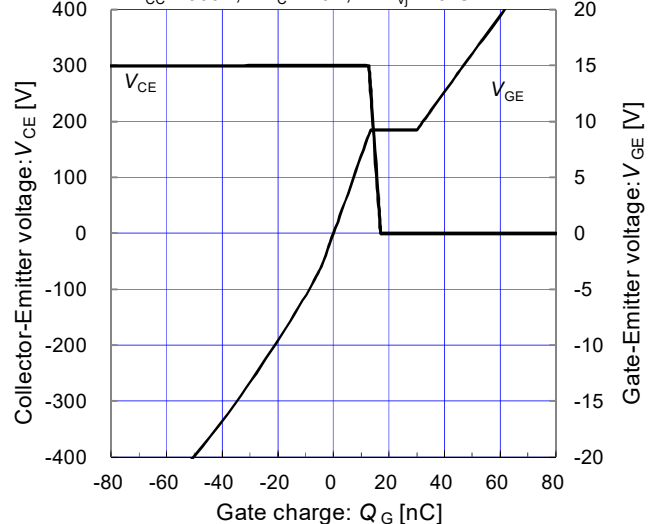

Warnings

1. This Catalog contains the product specifications, characteristics, data, materials, and structures as of 2/2023. The contents are subject to change without notice for specification changes or other reasons. When using a product listed in this Catalog, be sure to obtain the latest specifications.
2. All applications described in this Catalog exemplify the use of Fuji's products for your reference only. No right or license, either express or implied, under any patent, copyright, trade secret or other intellectual property right owned by Fuji Electric Co., Ltd. is (or shall be deemed) granted. Fuji Electric Co., Ltd. makes no representation or warranty, whether express or implied, relating to the infringement or alleged infringement of other's intellectual property rights which may arise from the use of the applications described herein.
3. Although Fuji Electric Co., Ltd. is enhancing product quality and reliability, a small percentage of semiconductor products may become faulty. When using Fuji Electric semiconductor products in your equipment, you are requested to take adequate safety measures to prevent the equipment from causing a physical injury, fire, or other problem if any of the products become faulty. It is recommended to make your design fail-safe, flame retardant, and free of malfunction.
4. The products introduced in this Catalog are intended for use in the following electronic and electrical equipment which has normal reliability requirements.
 - Computers · OA equipment · Communications equipment (terminal devices) · Measurement equipment
 - Machine tools · Audiovisual equipment · Electrical home appliances · Personal equipment · Industrial robots etc.
5. If you need to use a product in this Catalog for equipment requiring higher reliability than normal, such as for the equipment listed below, it is imperative to contact Fuji Electric Co., Ltd. to obtain prior approval. When using these products for such equipment, take adequate measures such as a backup system to prevent the equipment from malfunctioning even if a Fuji's product incorporated in the equipment becomes faulty.
 - Transportation equipment (mounted on cars and ships) · Trunk communications equipment
 - Traffic-signal control equipment · Gas leakage detectors with an auto-shut-off feature
 - Emergency equipment for responding to disasters and anti-burglary devices · Safety devices · Medical equipment
6. Do not use products in this Catalog for the equipment requiring strict reliability such as the following and equivalents to strategic equipment (without limitation).
 - Space equipment · Aeronautic equipment · Nuclear control equipment · Submarine repeater equipment
7. Copyright (c)1996-2023 by Fuji Electric Co., Ltd. All rights reserved.
No part of this Catalog may be reproduced in any form or by any means without the express permission of Fuji Electric Co., Ltd.
8. If you have any question about any portion in this Catalog, ask Fuji Electric Co., Ltd. or its sales agents before using the product. Neither Fuji Electric Co., Ltd. nor its agents shall be liable for any injury caused by any use of the products not in accordance with instructions set forth herein.

Technical Information

IGBT Modules

- Please refer to URLs below for further information about products, application manuals and design support.
- 关于本规格书中没有记载的产品信息，应用手册，技术信息等，请参考以下链接。
- 本データシートに記載されていない製品情報，アプリケーションマニュアル，デザインサポートは以下の URL をご参照下さい。

FUJI ELECTRIC Power Semiconductor WEB site

| | |
|---------------|--|
| 日本 | www.fujielectric.co.jp/products/semiconductor/ |
| Global | www.fujielectric.com/products/semiconductor/ |
| 中国 | www.fujielectric.com.cn/products/semiconductor/ |
| Europe | www.fujielectric-europe.com/en/power_semiconductor/ |
| North America | www.americas.fujielectric.com/products/semiconductors/ |

Information

| 日本 | |
|----------------------|--|
| 1 半導体総合カタログ | www.fujielectric.co.jp/products/semiconductor/catalog/ |
| 2 製品情報 | www.fujielectric.co.jp/products/semiconductor/model/ |
| 3 アプリケーションマニュアル | www.fujielectric.co.jp/products/semiconductor/model/igbt/application/ |
| 4 デザインサポート | www.fujielectric.co.jp/products/semiconductor/model/igbt/technical/ |
| 5 マウンティングインストラクション | www.fujielectric.co.jp/products/semiconductor/model/igbt/mounting/ |
| 6 IGBT 損失シミュレーションソフト | www.fujielectric.co.jp/products/semiconductor/model/igbt/simulation/ |
| 7 富士電機技報 | www.fujielectric.co.jp/products/semiconductor/journal/ |
| 8 製品のお問い合わせ | www.fujielectric.co.jp/products/semiconductor/contact/ |
| 9 改廃のお知らせ | www.fujielectric.co.jp/products/semiconductor/discontinued/ |

| Global | |
|--|--|
| 1 Semiconductors General Catalog | www.fujielectric.com/products/semiconductor/catalog/ |
| 2 Product Information | www.fujielectric.com/products/semiconductor/model/ |
| 3 Application Manuals | www.fujielectric.com/products/semiconductor/model/igbt/application/ |
| 4 Design Support | www.fujielectric.com/products/semiconductor/model/igbt/technical/ |
| 5 Mounting Instructions | www.fujielectric.com/products/semiconductor/model/igbt/mounting/ |
| 6 IGBT Loss Simulation Software | www.fujielectric.com/products/semiconductor/model/igbt/simulation/ |
| 7 Fuji Electric Journal | www.fujielectric.com/products/semiconductor/journal/ |
| 8 Contact | www.fujielectric.com/contact/ |
| 9 Revised and discontinued product information | www.fujielectric.com/products/semiconductor/discontinued/ |

| 中国 | |
|---------------|--|
| 1 半导体综合目录 | www.fujielectric.com.cn/products/semiconductor/catalog/ |
| 2 产品信息 | www.fujielectric.com.cn/products/semiconductor/model/ |
| 3 应用手册 | www.fujielectric.com.cn/products/semiconductor/model/igbt/application/ |
| 4 技术信息 | www.fujielectric.com.cn/products/semiconductor/model/igbt/technical/ |
| 5 安装说明书 | www.fujielectric.com.cn/products/semiconductor/model/igbt/mounting/ |
| 6 IGBT 损耗模拟软件 | www.fujielectric.com.cn/products/semiconductor/model/igbt/simulation/ |
| 7 富士电机技报 | www.fujielectric.com.cn/products/semiconductor/journal/ |
| 8 产品咨询 | www.fujielectric.com/contact/ |
| 9 产品更改和停产信息 | www.fujielectric.com.cn/products/semiconductor/discontinued/ |