

Side Channel Blower

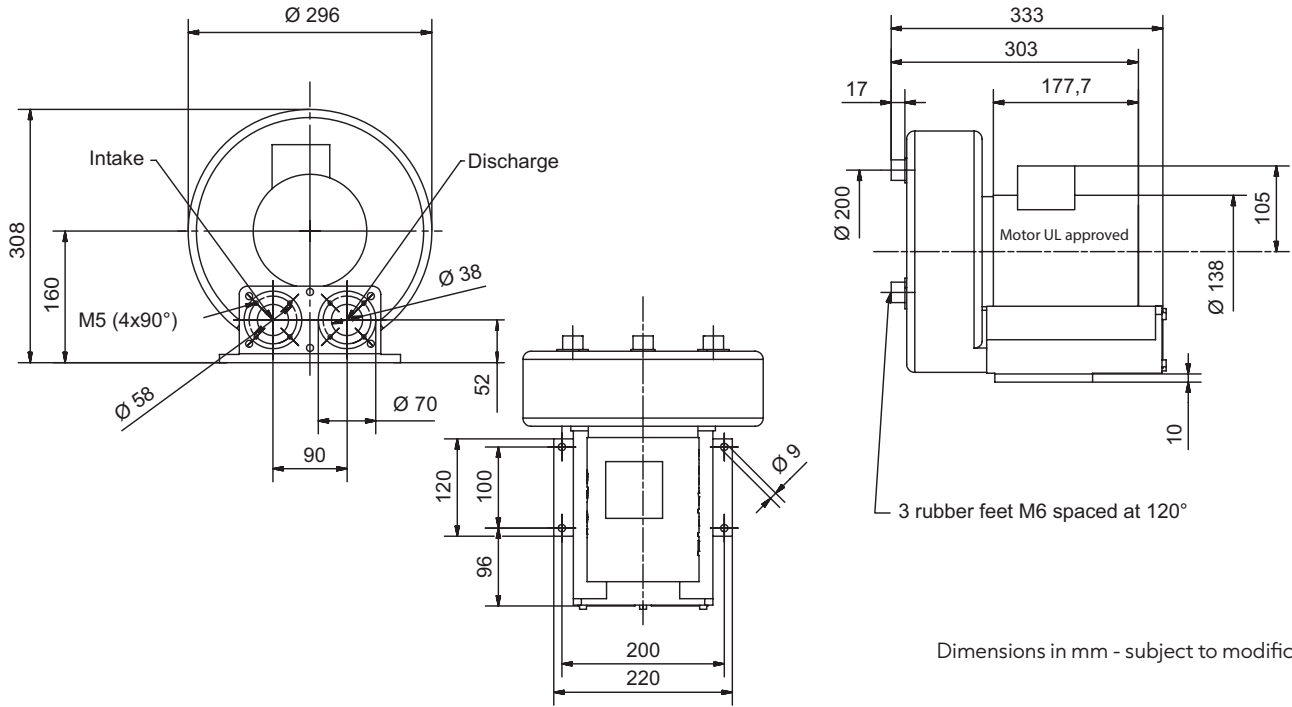

Model	Maximum Performance (when used as blower)		Maximum performance (when used as extractor)		Motor Ratings						Weight (approx.)
	V max.	Δp_t max.	V max.	Δp_t max.	Output	Voltage	Phase	Freq.	Current	RPM	
	SCFM	in. H ₂ O	SCFM	in. H ₂ O	HP	V	-	Hz	A	-	lbs
VFD-2-L	56	84	56	72	0.88	230	3	60	3.1	3430	33

Unit includes 1-1/4" NPT inlet and outlet flanges, NEMA Premium Efficiency motor, TEFC IP54

Pressure

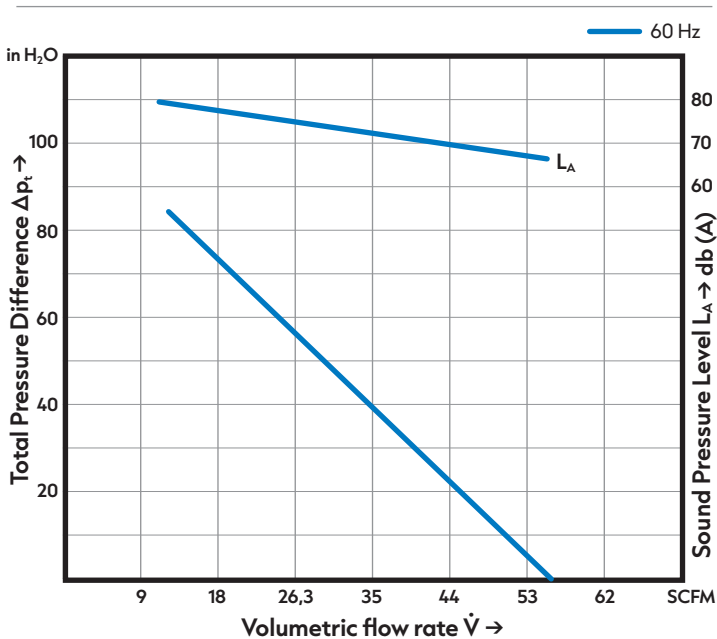

Vacuum

