

# FML60N104S2FDHF

## Super J MOS<sup>®</sup> S2 series

## N-Channel enhancement mode power MOSFET

### Features

- Pb-free lead terminal
- RoHS compliant
- Halogen-free molding compound
- MSL:1, Reflow available

### Applications

- For switching

### Package and Internal circuit chart

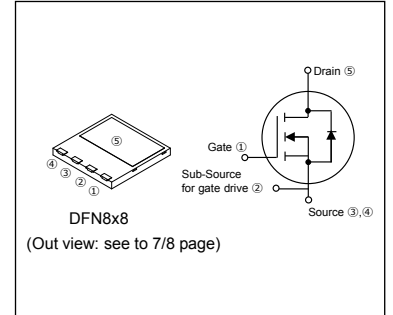

### Absolute Maximum Ratings at $T_c=25^\circ\text{C}$ (unless otherwise specified)

Parameter	Symbol	Characteristics	Unit	Remarks
Drain-Source Voltage	$V_{DS}$	600	V	
	$V_{DSX}$	600	V	$V_{GS}=-30V$
Continuous Drain Current	$I_D$	41.3	A	$T_c=25^\circ\text{C}$ Note*1,2
		26.1	A	$T_c=100^\circ\text{C}$ Note*1,2
Pulsed Drain Current	$I_{DP}$	120.4	A	Note *2
Gate-Source Voltage	$V_{GS}$	$\pm 30$	V	
Non-Repetitive Maximum Avalanche Current	$I_{AS}$	4.9	A	Note *3
Non-Repetitive Maximum Avalanche Energy	$E_{AS}$	809.3	mJ	Note *4
Maximum MOSFET $dv/dt$	$dv_{DS}/dt$	50	V/ns	$V_{GS} \leq 600V$
Continuous Diode Forward Current	$I_{DR}$	41.3	A	$T_c=25^\circ\text{C}$ Note*1,2
		26.1	A	$T_c=100^\circ\text{C}$ Note*1,2
Pulsed Diode Forward Current	$I_{DRP}$	120.4	A	Note *2
Peak Diode Recovery $dv/dt$	$dv/dt$	30	V/ns	Note *5
Peak Diode Recovery $-di_{DR}/dt$	$-di_{DR}/dt$	100	A/ $\mu\text{s}$	Note *6
Maximum Power Dissipation	$P_{tot}$	232	W	$T_c=25^\circ\text{C}$
		2.78	W	$T_a=25^\circ\text{C}$
Operating Channel Temperature	$T_{ch}$	150	$^\circ\text{C}$	
Storage Temperature	$T_{stg}$	-55 to +150	$^\circ\text{C}$	

Note \*1 : Maximum duty cycle  $D=0.53$

Note \*2 : Limited by maximum channel temperature.

Note \*3 :  $T_{ch} \leq 150^\circ\text{C}$ , See Figure 1 and 2.

Note \*4 : Starting  $T_{ch} = 25^\circ\text{C}$ ,  $I_{AS} = 3\text{ A}$ ,  $L = 165\text{ mH}$ ,  $V_{DD} = 60\text{ V}$ ,  $R_G = 50\ \Omega$ , See Figure 1 and 2.

$E_{AS}$  limited by maximum channel temperature and avalanche current.

Note \*5 :  $I_{DR} \leq 32.8\text{ A}$ ,  $-di_{DR}/dt \leq 100\text{ A}/\mu\text{s}$ ,  $V_{DS\text{ peak}} \leq 600\text{ V}$ ,  $T_{ch} \leq 150^\circ\text{C}$ .

Note \*6 :  $I_{DR} \leq 32.8\text{ A}$ ,  $dv/dt \leq 30\text{ V/ns}$ ,  $V_{DS\text{ peak}} \leq 600\text{ V}$ ,  $T_{ch} \leq 150^\circ\text{C}$ .

**Electrical Characteristics at  $T_c=25^\circ\text{C}$  (unless otherwise specified)**

**• Static characteristics**

Parameter	Symbol	Conditions	Min.	Typ.	Max.	Unit
Drain-Source Breakdown Voltage	$V_{(BR)DSS}$	$V_{GS} = 0\text{ V}$ $I_D = 250\ \mu\text{A}$	600	-	-	V
Gate Threshold Voltage	$V_{GS(th)}$	$V_{DS} = V_{GS}$ $I_D = 4.9\text{ mA}$	3.0	4.0	5.0	V
Zero Gate Voltage Drain Current	$I_{DSS}$	$V_{DS} = 600\text{ V}$ $V_{GS} = 0\text{ V}$ $T_{ch} = 25\ ^\circ\text{C}$	-	-	25	$\mu\text{A}$
		$V_{DS} = 480\text{ V}$ $V_{GS} = 0\text{ V}$ $T_{ch} = 125\ ^\circ\text{C}$	-	-	-	
Gate-Source Leakage Current	$I_{GSS}$	$V_{DS} = 0\text{ V}$ $V_{GS} = \pm 30\text{ V}$	-	10	100	nA
Drain-Source On-State Resistance	$R_{DS(on)}$	$V_{GS} = 10\text{ V}$ $I_D = 8.2\text{ A}$	-	0.093	0.104	$\Omega$
Gate resistance	$r_g$	$f = 1\text{ MHz}$ , open drain	-	7.5	-	$\Omega$

**• Dynamic characteristics**

Parameter	Symbol	Conditions	Min.	Typ.	Max.	Unit
Forward Transconductance	$g_{fs}$	$V_{DS} = 25\text{ V}$ $I_D = 16.4\text{ A}$	6	24	-	S
Input Capacitance	$C_{iss}$	$V_{DS} = 400\text{ V}$ $V_{GS} = 0\text{ V}$ $f = 250\text{ kHz}$	-	1720	-	$\mu\text{F}$
Output Capacitance	$C_{oss}$		-	60	-	
Reverse Transfer Capacitance	$C_{rss}$		-	7.9	-	
Effective output capacitance, energy related (Note *7)	$C_{o(er)}$	$V_{DS} = 0 \dots 400\text{ V}$ $V_{GS} = 0\text{ V}$	-	139	-	pF
Effective output capacitance, time related (Note *8)	$C_{o(tr)}$	$V_{DS} = 0 \dots 400\text{ V}$ $V_{GS} = 0\text{ V}$ $I_D = \text{constant}$	-	569	-	pF
Turn-On Time	$t_{d(on)}$	$V_{DD} = 400\text{ V}$ , $V_{GS} = 10\text{ V}$ $I_D = 16.4\text{ A}$ , $R_G = 20\ \Omega$ See Figure 3 and 4	-	36	-	ns
	$t_r$		-	33	-	
Turn-Off Time	$t_{d(off)}$		-	207	-	
	$t_f$		-	21	-	
Total Gate Charge	$Q_G$	$V_{DD} = 400\text{ V}$ , $V_{GS} = 10\text{ V}$	-	83	-	nC
Gate-Source Charge	$Q_{GS}$	$I_D = 32.8\text{ A}$	-	27	-	
Gate-Drain Charge	$Q_{GD}$	See Figure 5	-	47	-	

Note \*7 :  $C_{o(er)}$  is a fixed capacitance that gives the same stored energy as  $C_{oss}$  while  $V_{DS}$  is rising from 0 to 400V.

Note \*8 :  $C_{o(tr)}$  is a fixed capacitance that gives the same charging times as  $C_{oss}$  while  $V_{DS}$  is rising from 0 to 400V.

**• Reverse diode characteristics**

Parameter	Symbol	Conditions	Min.	Typ.	Max.	Unit
Diode Forward On-Voltage	$V_{DSR}$	$I_{DR} = 32.8\text{ A}$ , $V_{GS} = 0\text{ V}$ $T_{ch} = 25\ ^\circ\text{C}$	-	1.00	1.35	V
Reverse Recovery Time	$t_{rr}$	$V_{DD} = 400\text{ V}$ $I_{DR} = 32.8\text{ A}$ $V_{GS} = 0\text{ V}$ $-di_{DR}/dt = 100\text{ A}/\mu\text{s}$ $T_{ch} = 25\ ^\circ\text{C}$ See Figure 6 and 7	-	185	-	ns
Reverse Recovery Charge	$Q_{rr}$		-	1.6	-	$\mu\text{C}$
Peak Reverse Recovery Current	$I_{rrm}$		-	15.8	-	A

**■ Thermal Resistance**

Parameter	Symbol	Conditions	Min.	Typ.	Max.	Unit
Thermal Resistance, Channel – Ambient	$R_{th(ch-a)}$	Device mounted on PCB (FR4) Size: 40mm*40mm*1.5mm with 6cm <sup>2</sup> copper area (one layer, 70 $\mu\text{m}$ thickness) for drain connection and cooling.	-	-	45	$^\circ\text{C}/\text{W}$
Thermal Resistance, Channel – Case	$R_{th(ch-c)}$		-	-	0.539	$^\circ\text{C}/\text{W}$

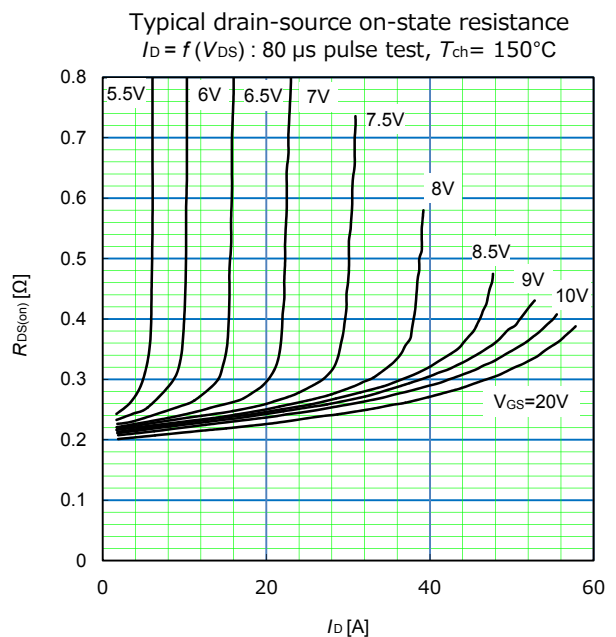
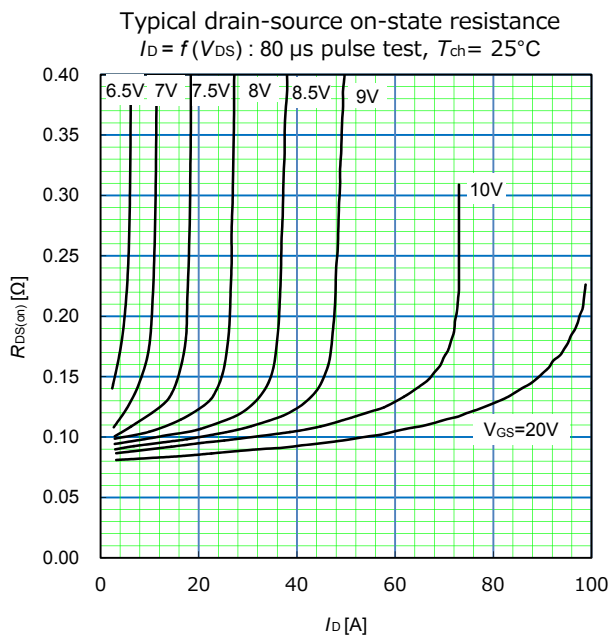
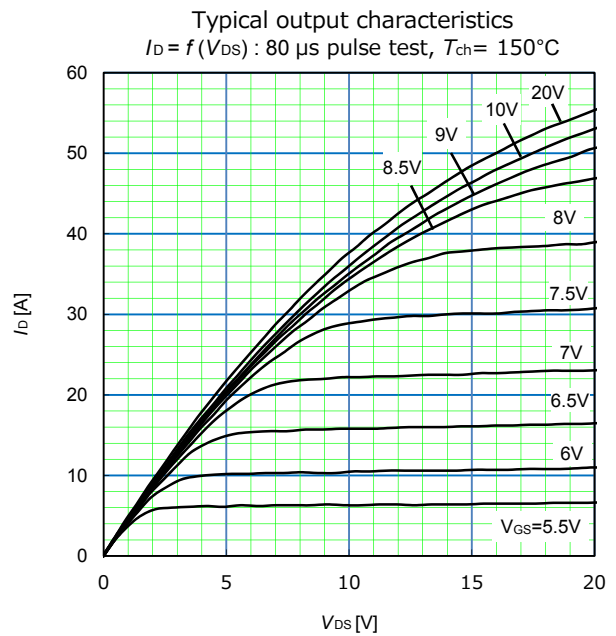
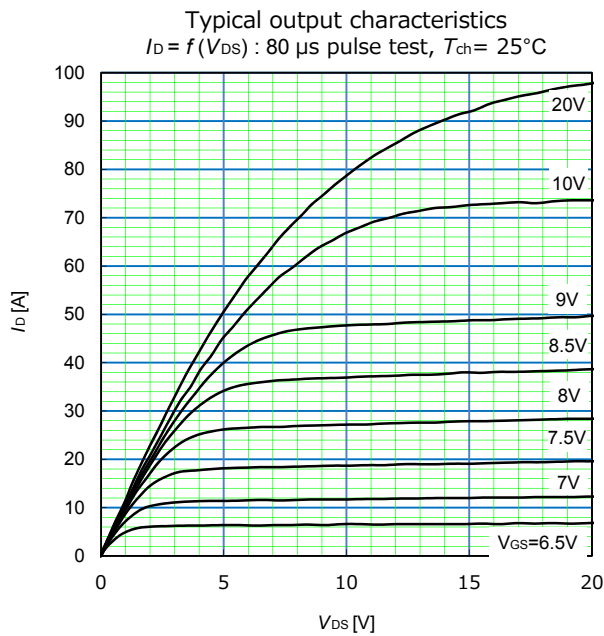
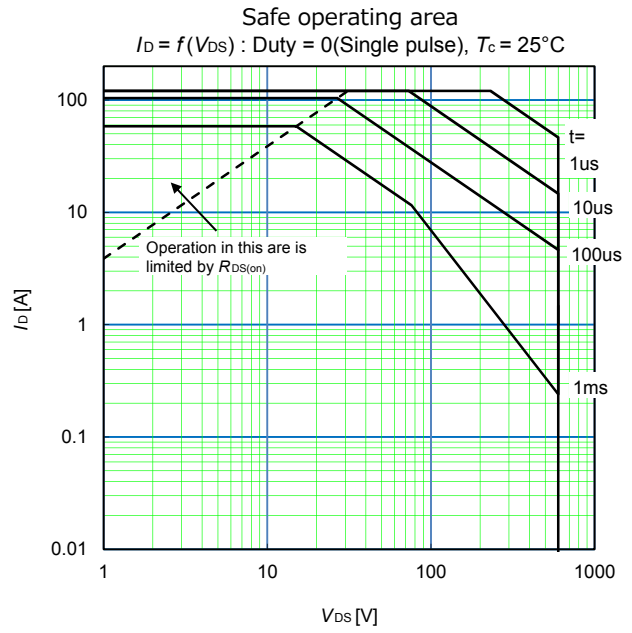
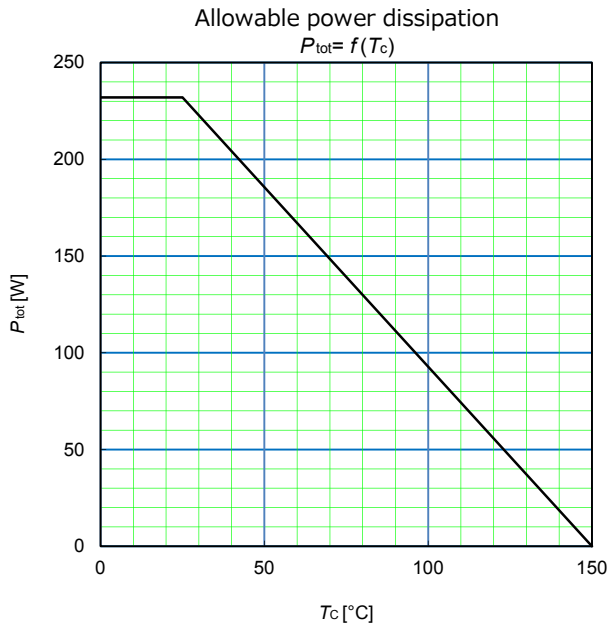

Drain-source on-state resistance  
 $R_{DS(on)} = f(T_{ch}) : I_D = 16.4 \text{ A}, V_{GS} = 10 \text{ V}$

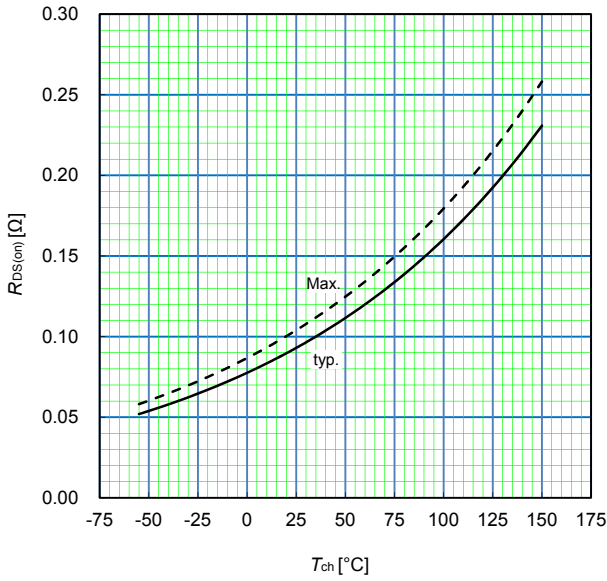

Gate threshold voltage  
 $V_{GS(th)} = f(T_{ch}) : V_{DS} = V_{GS}, I_D = 4.9 \text{ mA}$

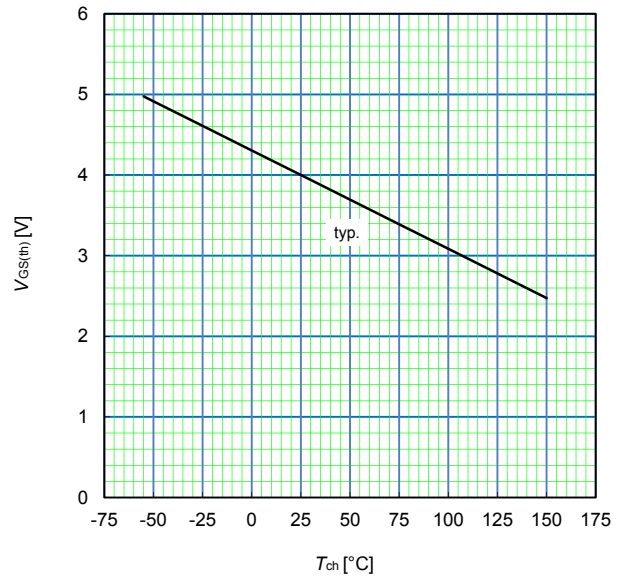

Typical transfer characteristic  
 $I_D = f(V_{GS}) : 80 \mu\text{s pulse test}, V_{DS} = 25 \text{ V}$

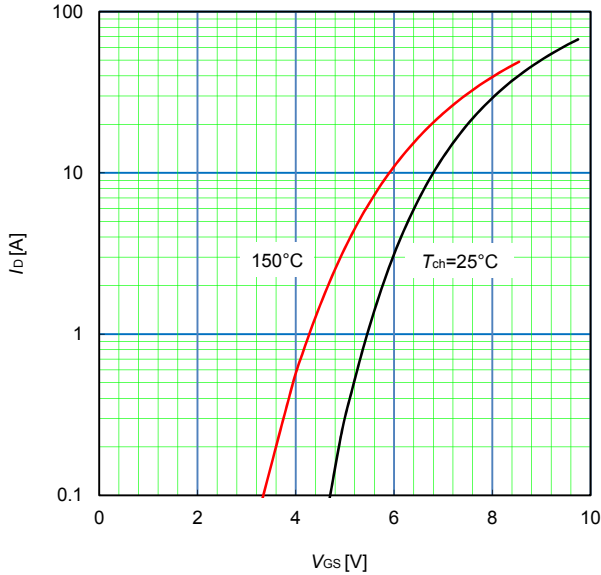

Typical transconductance  
 $g_{fs} = f(I_D) : 80 \mu\text{s pulse test}, V_{DS} = 25 \text{ V}$

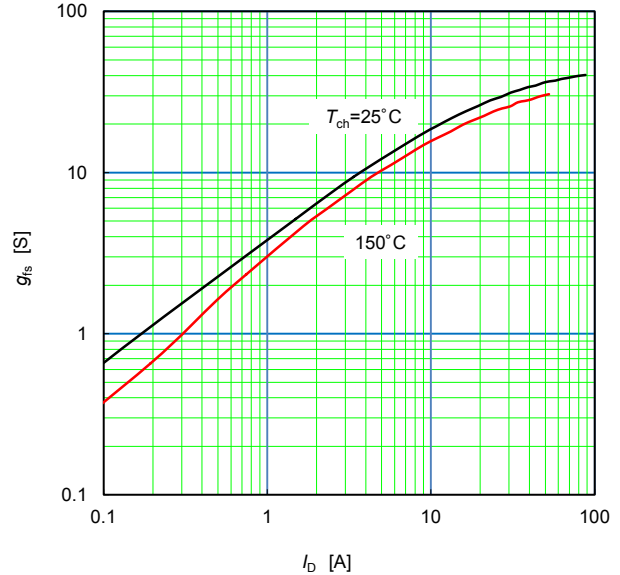

Typical forward characteristics of reverse diode  
 $I_{DR} = f(V_{DSR}) : 80 \mu\text{s pulse test}$

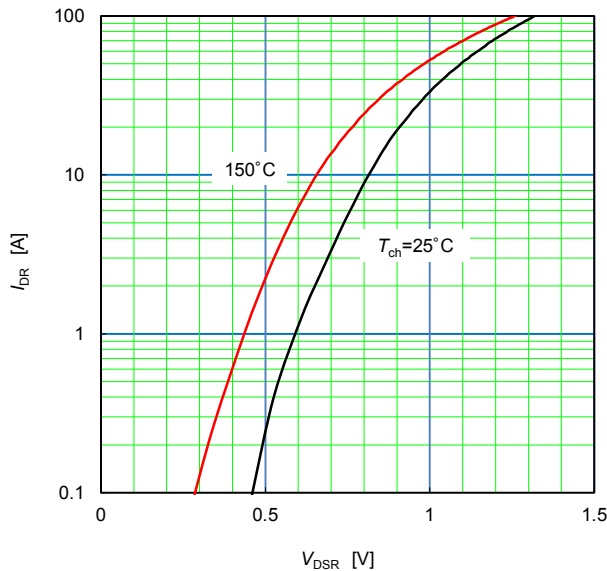

Typical capacitance  
 $C = f(V_{DS}) : V_{GS} = 0 \text{ V}, f = 250 \text{ kHz}$

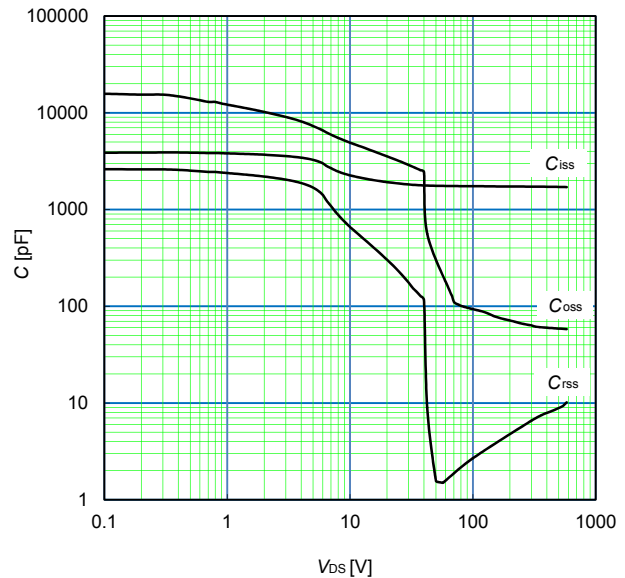

Typical  $C_{oss}$  stored energy

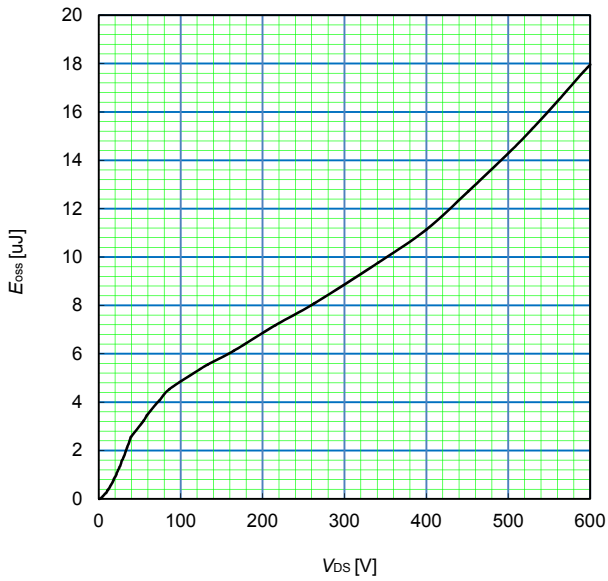

Typical switching times vs.  $I_D$   
 $t = f(I_D) : V_{DD} = 400 \text{ V}, V_{GS} = 10 \text{ V/0 V}, R_G = 20 \Omega, T_{ch} = 25^\circ\text{C}$

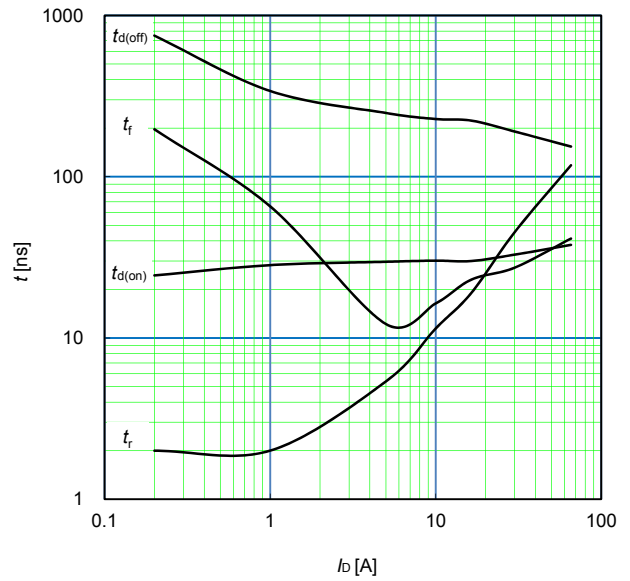

Typical gate charge  
 $V_{GS} = f(Q_G) : I_D = 32.8 \text{ A}, T_{ch} = 25^\circ\text{C}$

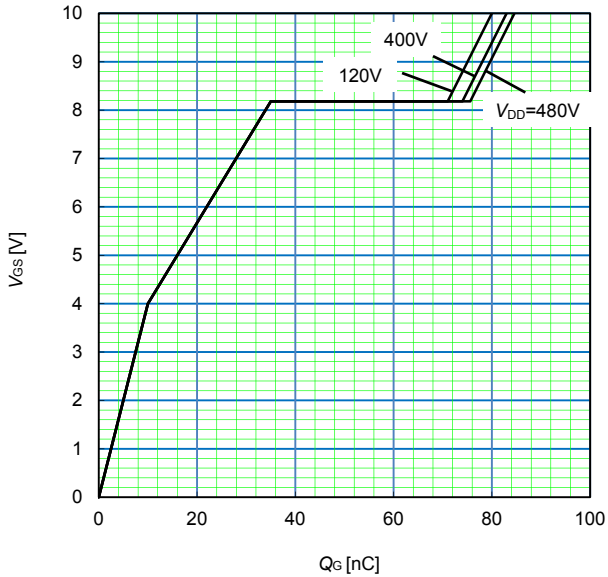

Maximum Avalanche Energy  
 $E_{AV} = f(\text{starting } T_{ch}) : V_{DD} = 60 \text{ V}, I_{AS} \leq 4.9 \text{ A}$

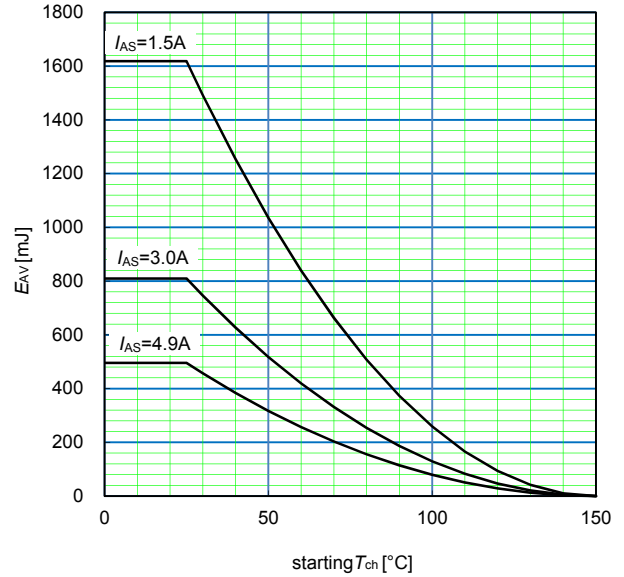

Transient Thermal Impedance  
 $Z_{th(ch-c)} = f(t) : D = 0$

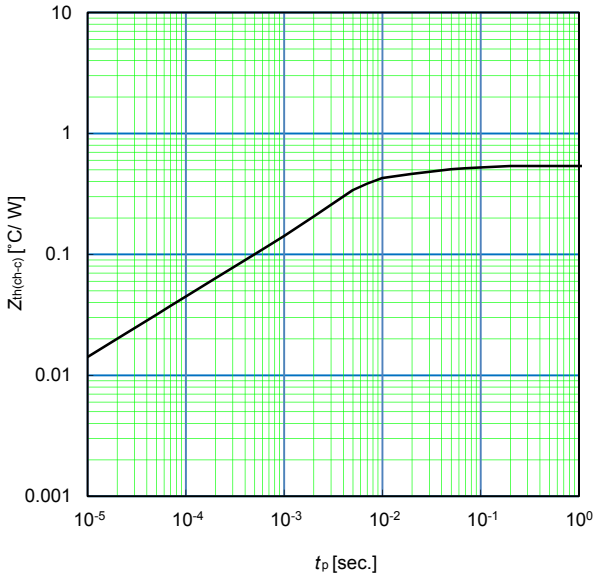

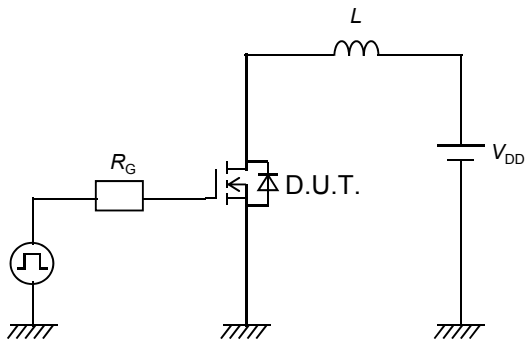

Figure 1. Unclamped inductive load test circuit

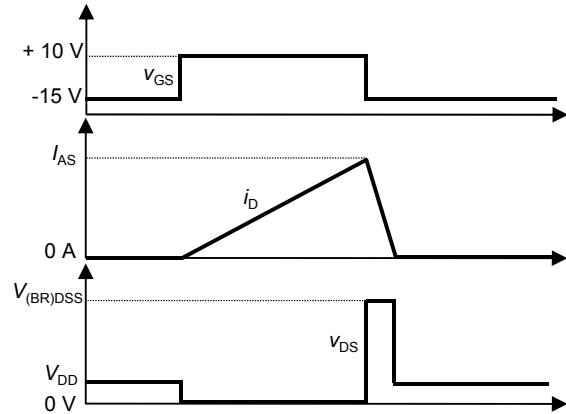

Figure 2. Unclamped inductive waveform

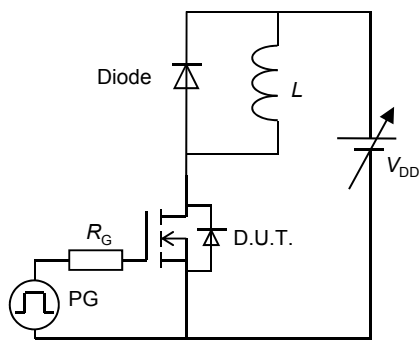

Figure 3. Switching test circuit

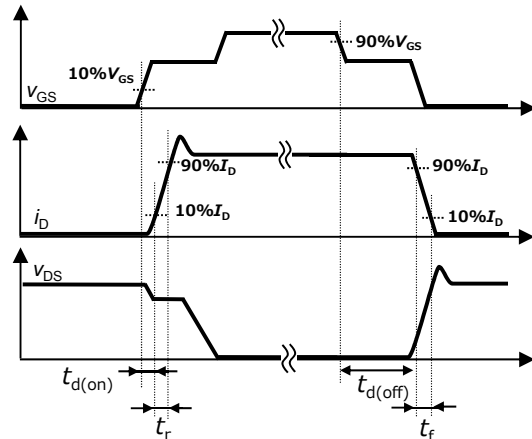

Figure 4. Switching times waveform

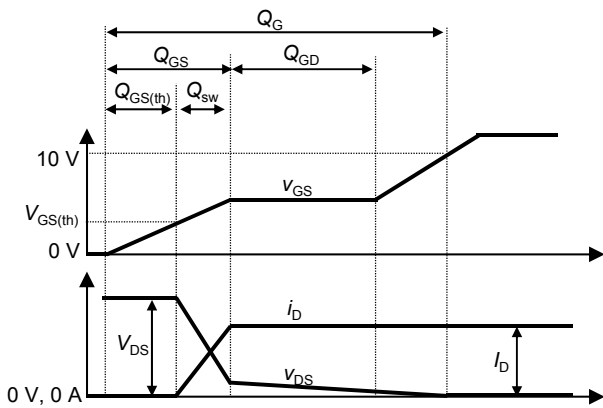

Figure 5. Gate charge waveform

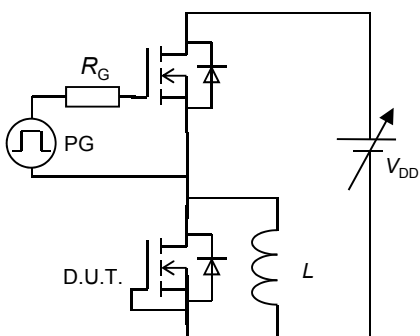

Figure 6. Diode reverse recovery test circuit

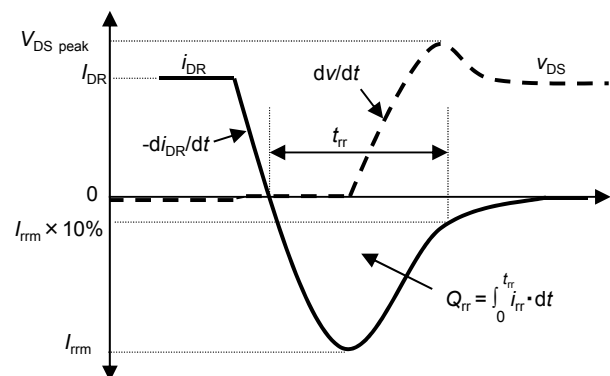
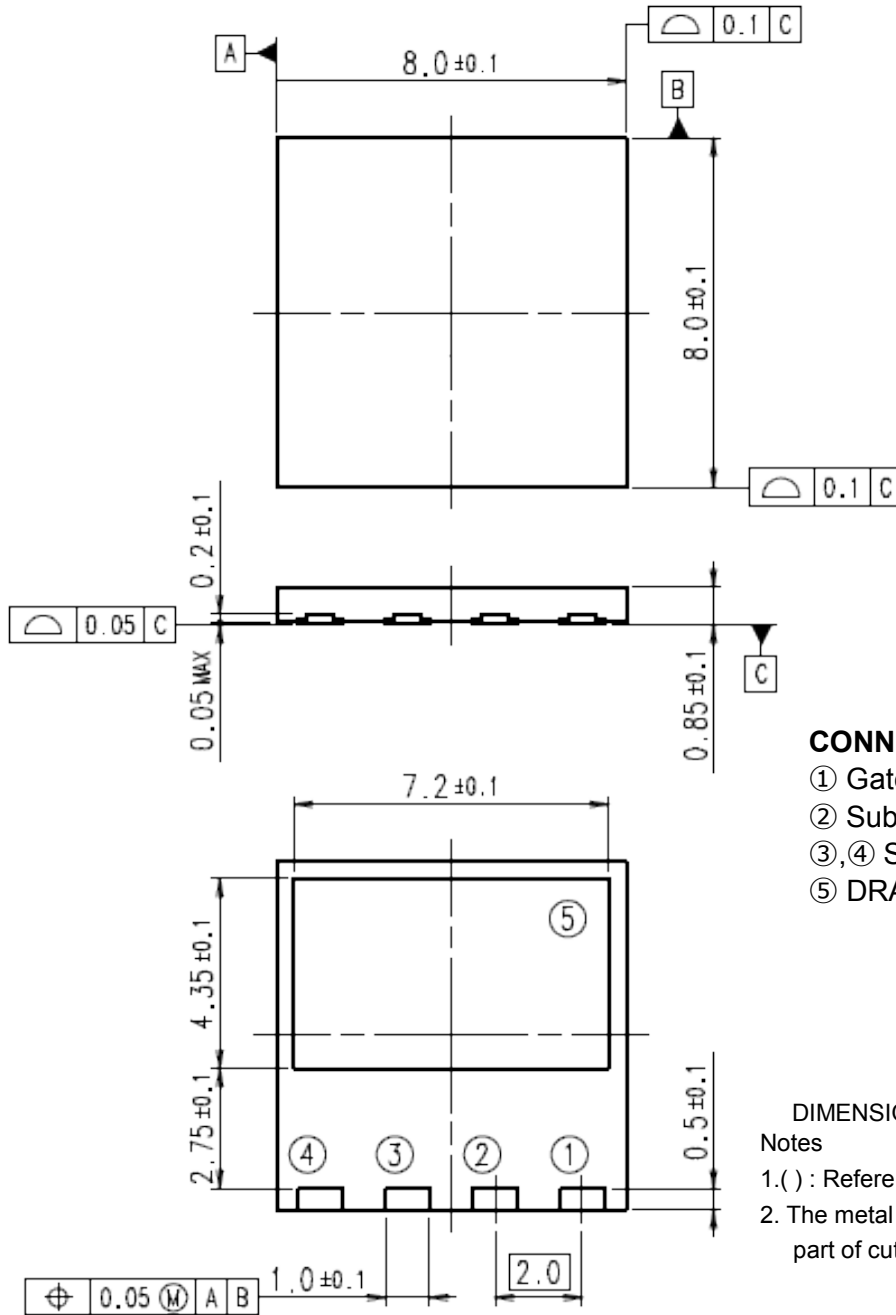

Figure 7. Diode reverse recovery waveform

■ Package Dimensions : DFN8x8 Package



CONNECTION

- ① Gate
- ② Sub-Source for Gate Drive
- ③,④ Source
- ⑤ DRAIN

DIMENSIONS ARE IN MILLIMETERS

Notes

- 1.( ) : Reference dimensions.
- 2. The metal part is covered with the solder plating, part of cutting is without the solder plating.

■ Marking

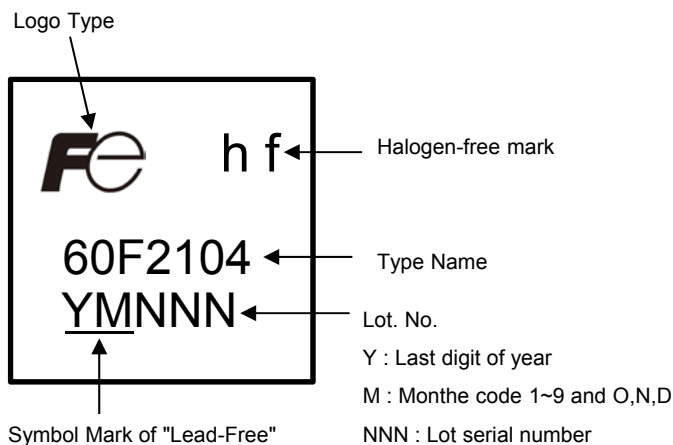

\* The font (font type,size) and the trademark-size might be actually different.

■ Recommended footprint

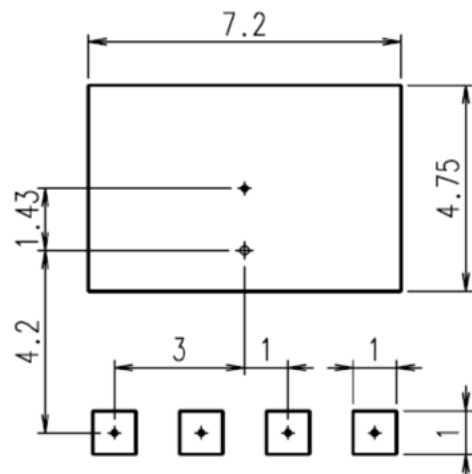

**WARNING**

1. This Catalog contains the product specifications, characteristics, data, materials, and structures as of November 2020. The contents are subject to change without notice for specification changes or other reasons. When using a product listed in this Catalog, be sure to obtain the latest specifications.
2. All applications described in this Catalog exemplify the use of Fuji's products for your reference only. No right or license, either express or implied, under any patent, copyright, trade secret or other intellectual property right owned by Fuji Electric Co., Ltd. is (or shall be deemed) granted. Fuji Electric Co., Ltd. makes no representation or warranty, whether express or implied, relating to the infringement or alleged infringement of other's intellectual property rights which may arise from the use of the applications described herein.
3. Although Fuji Electric Co., Ltd. is enhancing product quality and reliability, a small percentage of semiconductor products may become faulty. When using Fuji Electric semiconductor products in your equipment, you are requested to take adequate safety measures to prevent the equipment from causing a physical injury, fire, or other problem if any of the products become faulty. It is recommended to make your design failsafe, flame retardant, and free of malfunction.
4. The products introduced in this Catalog are intended for use in the following electronic and electrical equipment which has normal reliability requirements.
  - Computers
  - OA equipment
  - Communications equipment (terminal devices)
  - Measurement equipment
  - Machine tools
  - Audiovisual equipment
  - Electrical home appliances
  - Personal equipment
  - Industrial robots etc.
5. If you need to use a product in this Catalog for equipment requiring higher reliability than normal, such as for the equipment listed below, it is imperative to contact Fuji Electric Co., Ltd. to obtain prior approval. When using these products for such equipment, take adequate measures such as a backup system to prevent the equipment from malfunctioning even if a Fuji's product incorporated in the equipment becomes faulty.
  - Transportation equipment (mounted on cars and ships)
  - Trunk communications equipment
  - Traffic-signal control equipment
  - Gas leakage detectors with an auto-shut-off feature
  - Emergency equipment for responding to disasters and anti-burglary devices
  - Safety devices
  - Medical equipment
6. Do not use products in this Catalog for the equipment requiring strict reliability such as the following and equivalents to strategic equipment (without limitation).
  - Space equipment
  - Aeronautic equipment
  - Nuclear control equipment
  - Submarine repeater equipment
7. Copyright ©1996-2020 by Fuji Electric Co., Ltd. All rights reserved.  
No part of this Catalog may be reproduced in any form or by any means without the express permission of Fuji Electric Co., Ltd.
8. If you have any question about any portion in this Catalog, ask Fuji Electric Co., Ltd. or its sales agents before using the product. Neither Fuji Electric Co., Ltd. nor its agents shall be liable for any injury caused by any use of the products not in accordance with instructions set forth herein.