

INFRARED GAS ANALYZER

Type: ZRE

A maximum of 5 gas components
(of NO_x, SO₂, CO, CO₂, CH₄, and O₂)
can be measured simultaneously and continuously.



Simultaneous and continuous measurement of the concentration of up to 5 gas components

Excellent prolonged stability

Compact size and simple operation

Virtually unaffected by the interference of moisture.

Substantial functions, including automatic calibration, communications, and alarms (Option)

Measurement of
5 components
with just one unit

Compact body packed with abundant functions Fuji infrared gas analyzer

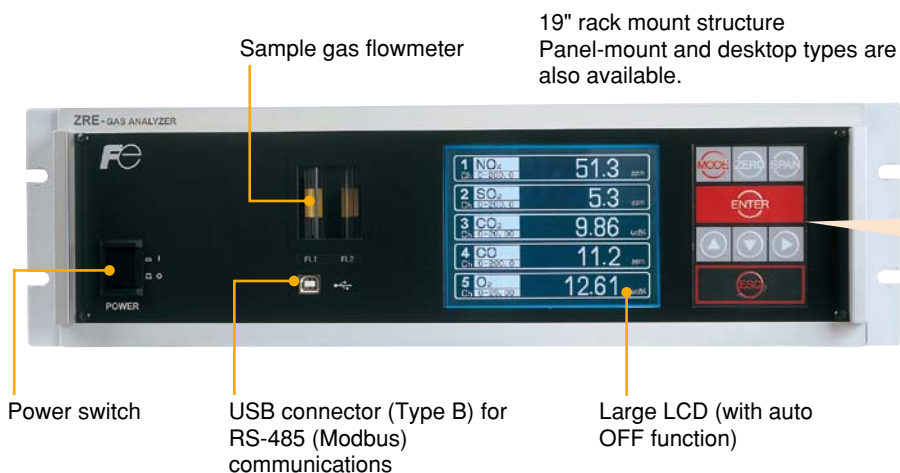

Simple key operation

Mode select switch
Used to switch modes.

Zero calibration key
Used for manual zero calibration.

Span calibration key
Used for manual span calibration

Enter key
Used to confirm the selected items and numeric values.

Up/down key
Used to switch the items to be selected.

Escape key
Used to return to the previous screen or abort setting midway.

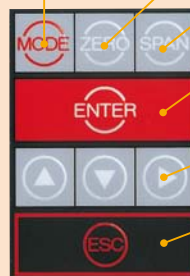

Easy-view large LCD

Instruction in English facilitates operation.

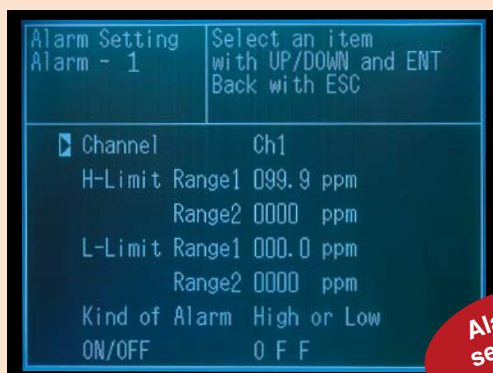
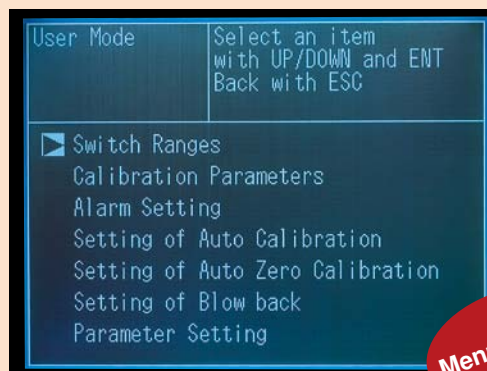
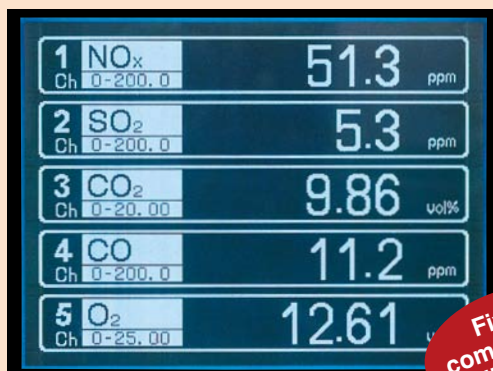

Neat rear face to facilitate connection

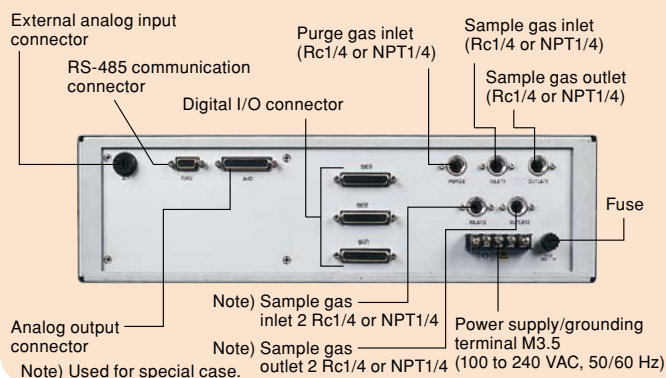

Short depth Light weight (approximately 8 kg)

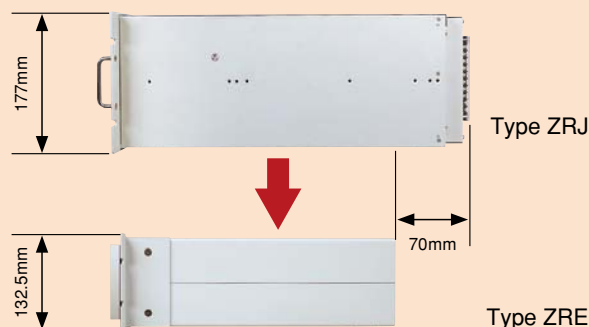

Adoption of our unique infrared ray single-beam system

Measures the concentration of up to 5 gas components simultaneously and continuously.

The concentration of five gas components (of SO₂, NO_x, CO, CO₂, CH₄, and O₂) can be measured. For example, the components in flue exhaust gas (SO₂, NO_x, CO, CO₂, and O₂) can be measured simultaneously and continuously.

	NO	SO ₂	CO	CO ₂	CH ₄	O ₂
Single-component analyzer	○	○	○	○	○	Can be added by designation
Double-component analyzer	○ ○	○	○ ○	○ ○	○ ○	Can be added by designation
Three-component analyzer	○	○	○ ○	○ ○	○ ○	Can be added by designation
Four-component analyzer	○	○	○	○		Can be added by designation

Measurement range

NO: 0-200ppm 5000ppm

SO₂: 0-200ppm 10%

CO₂: 0-100ppm 100%

CO: 0-200ppm 100%

CH₄: 0-500ppm 100%

O₂: 0-5% 25%

Excellent prolonged stability, easy maintenance, and high-precision measurement with repeatability of 0.5%

Principle The amount of infrared ray absorbed in the measuring cell is detected with the mass flow sensor.

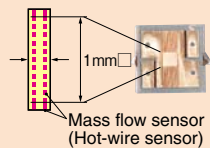
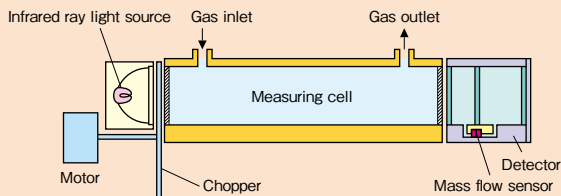

<Mass flow sensor>

The mass flow sensor, with low impedance, has excellent noise resistance, while the sensor, with no movable parts, is impervious to vibration and can be used on a semi-permanent basis.

Hot-wire temperature

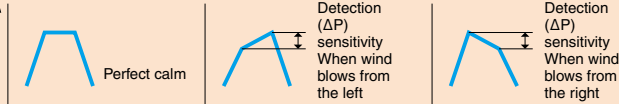

Communication with a PC achieved with RS485 (Modbus) communication function (Option)



RS-485 (Modbus) communication

With the USB connector (gauge on the front face), RS485 connector for communication on the rear face

Details of communication: Read/write of various settings, output of measured concentration value and instrument status

Virtually unaffected by the interference of moisture

Analysis is almost unaffected by any moisture present in the sample gas. Our unique interference correcting function has significantly reduced the effect of moisture.

Interference component	CO ₂ sensor	CO sensor	CH ₄ sensor	SO ₂ sensor	NO sensor
H ₂ O saturation at 20°C	1% or lower	1% or lower	1% or lower	-	-
H ₂ O saturation at 2°C	-	2.5% or lower	-	2% or lower	2% or lower
CO 1000ppm	1% or lower	-	1% or lower	1% or lower	1% or lower
CO ₂ 15%	-	1% or lower	1% or lower	1% or lower	2% or lower
CH ₄ 1000ppm	1% or lower	1% or lower	-	50ppm or lower	-

Zero/span auto calibration function (option) eliminates irksome calibration work.

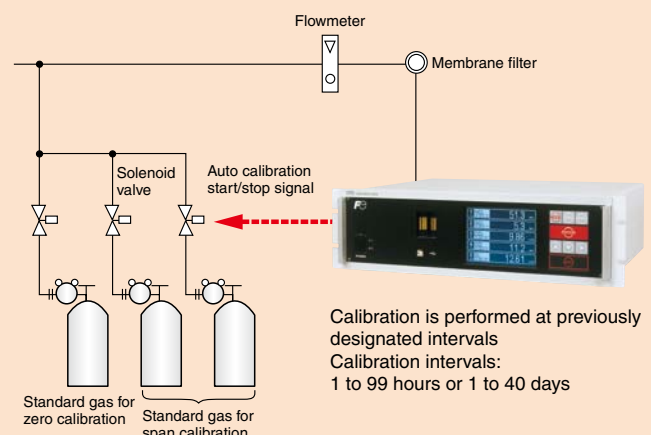

Abundant digital I/O signals (Option)

External digital input signal

Range switching, auto calibration start, output signal hold, average value reset



Digital output signal (1c relay contact)

Identification of each component range, instrument failure, calibration error, auto calibration in progress, upper/lower limit alarm for each component, pump ON/OFF, solenoid valve drive for auto calibration

Simple gas sampling system backed by a substantial track record

Example of measurement of exhaust gas from a boiler or refuse incinerator (NO, SO₂, CO, CO₂, and O₂ measurement)

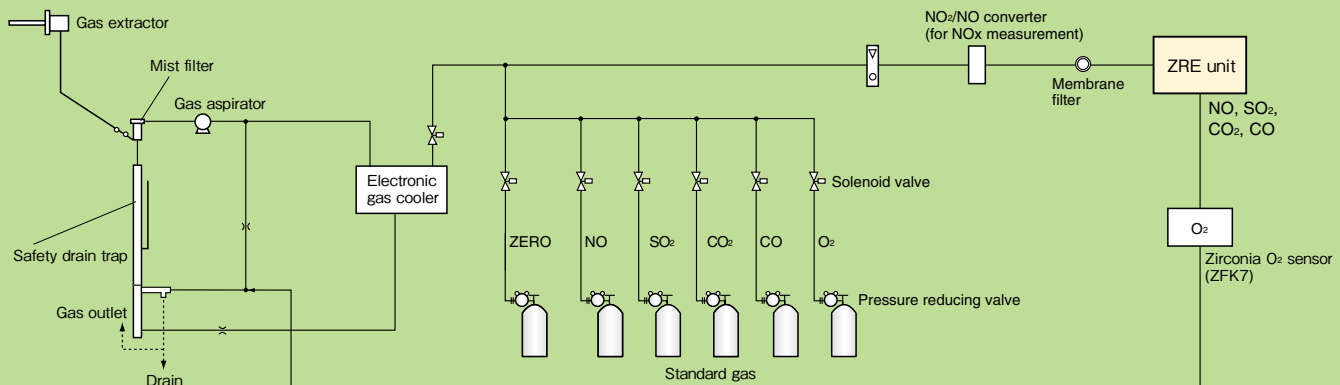

Example of measurement of CO, CH₄, and CO₂ from an industrial furnace

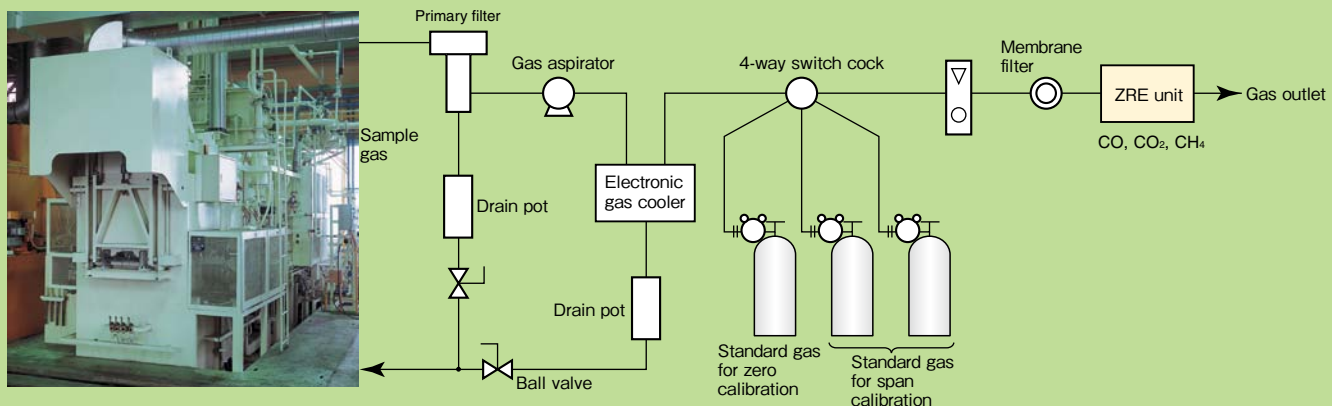

Easy installation to equipment

NO₂ → NO gas converter (Type: ZDLO4)



- Target gas: Exhaust gas from general boilers, atmosphere
- Catalyst usage: 2 cm³
- Catalyst replacement interval: Approximately 1 year
- Flow rate of the gas to be analyzed: 0.5 L/min or lower
- Conversion efficiency: 90% or higher (conforming to JIS)
- Temperature control: Built in
- Power supply voltage: 100 to 240 VAC, 50/60 Hz
- External dimensions: 212(H)x148(W)x130(D) mm

Zirconia oxygen sensor (Type: ZFK7)

- Measurement range: 0 to 25%
- Repeatability: Within ±0.5% of full scale
- Zero drift: Within ±1% of full scale/week
- Span drift: Within ±2% of full scale/week
- Response time: Approximately 20 sec (90% response)
- Temperature control: Built in
- Oxygen concentration display: Displayed on the gas analyzer connected
- Flow rate of the gas measured: 0.5±0.25 L/min
- Power supply voltage: 100 to 115 VAC, 50/60 Hz
- External dimensions: 140(H)x170(W)x190(D) mm



Gas extractor applicable up to 1300°C

(Type: ZBAK2)

- System: Electrical heating
- Maximum temperature of the gas used: 800°C or 1300°C
- Material of the gas-contacting area: SUS316, Viton
- Extractor material: SUS316 or SiC
- Mounting method: Flange
- Sample gas outlet: Rc1/2
- Filter: SUS316 wire mesh (40 μm)
- Power supply voltage: 100 VAC, 50/60 Hz, 100 VA



Electronic gas cooler

(Type: ZBC9)

- Fixed dehumidification flow rate (Max.): 1.5 L/min
- Inlet gas temperature: 40°C or lower
- Output gas dew point: 0.5°C to 3°C
- Pressure: 50 kPa (Max.)
- Power supply voltage: 100 VAC, 50/60 Hz
- Gas outlet/inlet: Rc1/4
- Dehumidification check function: With check terminal
- External dimensions: 250(H)x200(W)x167(D) mm



• Examples of Application

Infrared CH₄, CO₂ and O₂ gas analyzers optimum for bio-gas measurement.

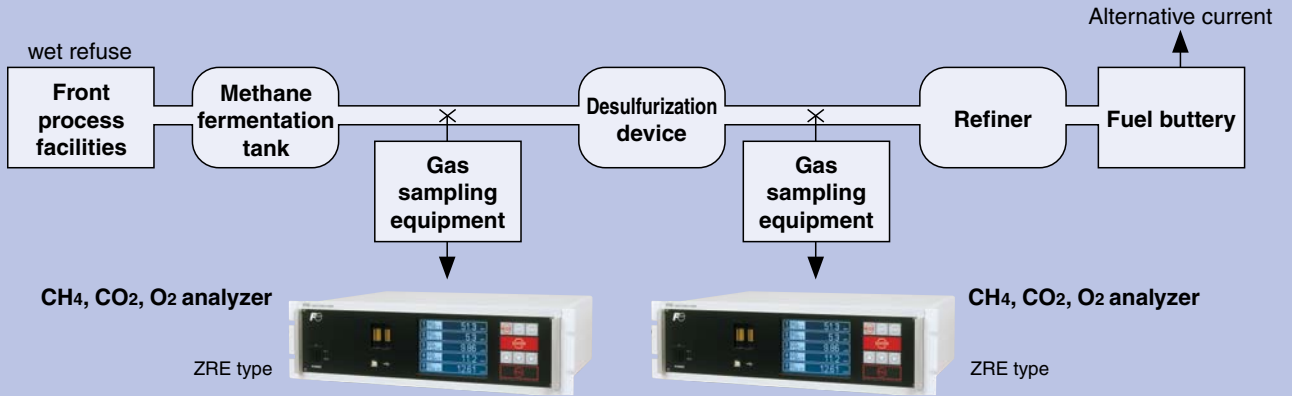

Infrared CO₂ and O₂ gas analyzer for storage of foodstuffs such as vegetable and fruit.

Foodstuffs can be kept fresh by controlling the CO₂ and O₂ concentrations properly in a storage house.

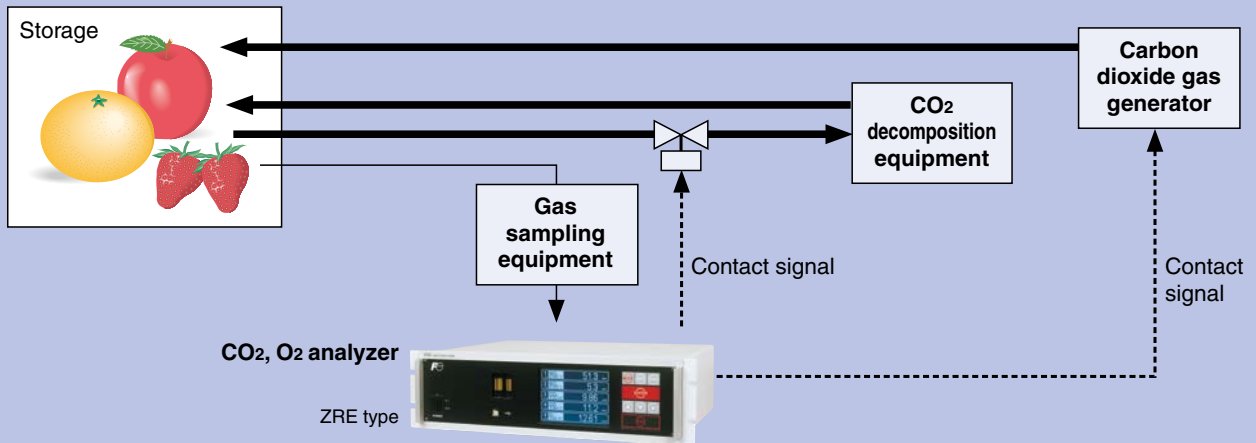

Example of measurement of exhaust gas from a boiler or refuse incinerator (NO, SO₂, CO, CO₂, and O₂ measurement)

A maximum of 5 gas components (of NO_x, SO₂, CO, CO₂, and O₂) can be measured simultaneously and continuously.

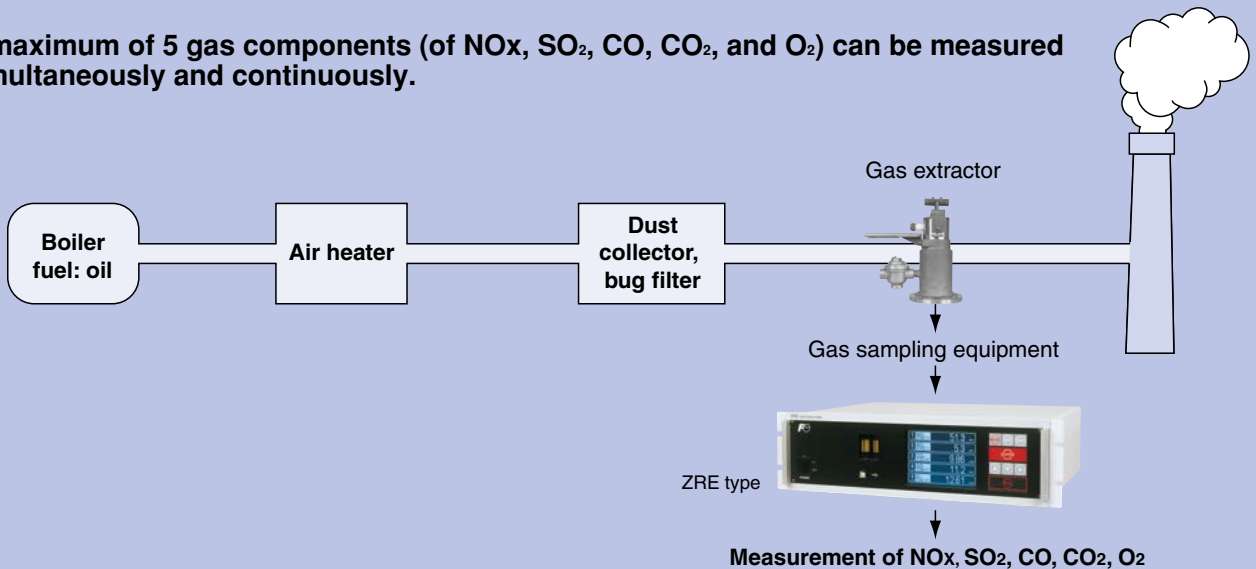

Code symbols



ZRE

4	5	6	7	8	9	10	11	12	13	14	15	16	17	18	19	20	21	22	23	24	25	
A				2																Y		

Digit	Description	Note	Code
4	Standard		A
5	<Installation structure> 19" rack mount type, Conforming to EIS 19" rack mount type, Conforming to JIS Panel mount type		B C D
6	<Measurable components (NO, SO ₂ , CO, CH ₄)> 1st 2nd 3rd 4th None NO SO ₂ CO ₂ CO CH ₄ NO SO ₂ NO CO CO CO CH ₄ CO CO ₂ CH ₄ NO SO ₂ CO CO CO CH ₄ NO SO ₂ CO CO Others	Note 1	Y P A D B E F G J K L N T V Z
7	<Measurable component (O ₂)> None External O ₂ sensor (0 to 1 VDC) External zirconia O ₂ sensor (Type ZFK7) Built-in fuel cell O ₂ sensor Built-in paramagnetic O ₂ sensor	Note 2	Y 1 2 3 4
9	<1st component, 1st measurement range> See Table 1.	Note 3	<input type="checkbox"/>
10	<1st component, 2nd measurement range> See Table 1.	Note 3	<input type="checkbox"/>
11	<2nd component, 1st measurement range> See Table 1.	Note 3	<input type="checkbox"/>
12	<2nd component, 2nd measurement range> See Table 1.	Note 3	<input type="checkbox"/>
13	<3rd component, 1st measurement range> See Table 1.	Note 3	<input type="checkbox"/>
14	<3rd component, 2nd measurement range> See Table 1.	Note 3	<input type="checkbox"/>
15	<4th component, 1st measurement range> See Table 1.	Note 3	<input type="checkbox"/>
16	<4th component, 2nd measurement range> See Table 1.	Note 3	<input type="checkbox"/>
17	<Measurable range (O ₂ sensor)> None 0 to 5/10% 0 to 5/25% 0 to 10/25% 0 to 5% 0 to 10% 0 to 25% 0 to 50% 0 to 100% Others		Y A B C L M V P R Z
18	<Gas outlet/inlet connection> Rc1/4 NPT1/4		1 2
19	<Output signal> 0 to 1 VDC 4 to 20 mA DC 0 to 1 VDC + RS485 communication function 4 to 20 mA DC + RS485 communication function		A B C D

Digit	Description	Note	Code
20	<Display> Japanese English Chinese		J E C
21	<O ₂ collection and O ₂ average value output> None With O ₂ correction output With O ₂ correction output, O ₂ correction and average output	Note 4	Y A C
22	<Optional function (DI, DO)> FAULT Auto Upper/lower Range identi- calibration calibration limit alarm fication/Remote None ○	Note 5	Y A B C D E F G H
24	<Unit> ppm, % mg/m ³ , g/m ³	Note 6	A B
25	<Adjustment> Standard For heat treatment furnace For converter Others	Note 7	A C D Z

Table 1.
<Measurement range code table>

Measurement range	Code
0 to 100ppm	B
0 to 200ppm	C
0 to 250ppm	D
0 to 300ppm	S
0 to 500ppm	E
0 to 1000ppm	F
0 to 2000ppm	G
0 to 2500ppm	U
0 to 3000ppm	T
0 to 5000ppm	H
0 to 1%	J
0 to 2%	K
0 to 3%	Q
0 to 5%	L
0 to 10%	M
0 to 20%	N
0 to 25%	V
0 to 40%	W
0 to 50%	P
0 to 70%	X
0 to 100%	R
Others	Z

- Note 1: Specify code "Y" when the O₂ sensor only is required. When NO, SO₂ measurement is specified [Auto calibration] must be specified 22th digit.
- Note 2: Feed input signals from the external O₂ sensor linearly within the range 0 to 1 VDC against the full scale. Our exclusive zirconia O₂ sensor (ZFK7) and external oxygen sensor are also optionally available.
- Note 3: Select the measurable component and range from the table on pages 7. If code "Y" is selected for the 6th digit, specify "Y" for all of the digits from the 9th to 16th.
- Note 4: O₂ correction output and O₂ correction average output are made for NO, SO₂, and CO only.
- Note 5: Not applicable to the 5-component sensor. The number of output points for upper/lower limit alarms is 3 for the 4-component sensor.
- Note 6: Even if code "B" is specified, select the measurement range in unit of ppm. A value converted into the mg/m³ range will be delivered. Applicable only to NO, SO₂, and CO sensors. See the following table for correspondence between ppm and mg/m³.
- Note 7: Adjustment will be made using the following balance gas for all the codes from "A" to "D" before delivery. Specify "Z" if adjustment with other gases is desired. Standard "A": Balance gas N₂, "C" for heat treat furnace: Balance gas 30% H₂/70% N₂, "D" for converter: Balance gas CO, CO₂. Attach a table that lists the components contained in the gas to be measured if "Others" is specified.

If mg/m³ is selected, specify the minimum to maximum range in ppm that corresponds to your desired range expressed in mg/m³. Delivery will be made with adjustment made to satisfy the corresponding mg/m³ range.
The conversion formula "ppm" unit into "mg/m³" unit.
NO (mg/m³) = 1.34 × NO (ppm)
SO₂ (mg/m³) = 2.86 × SO₂ (ppm)
CO (mg/m³) = 1.25 × CO (ppm)

Range code	Unit: ppm	Corresponding range expressed in mg/m ³		
		NO	SO ₂	CO
C	0 to 200ppm	0 to 260mg/m ³	0 to 570mg/m ³	0 to 250mg/m ³
D	0 to 250ppm	0 to 325mg/m ³	0 to 700mg/m ³	0 to 300mg/m ³
S	0 to 300ppm	0 to 400mg/m ³	0 to 850mg/m ³	0 to 375mg/m ³
E	0 to 500ppm	0 to 650mg/m ³	0 to 1400mg/m ³	0 to 600mg/m ³
F	0 to 1000ppm	0 to 1300mg/m ³	0 to 2800mg/m ³	0 to 1250mg/m ³
G	0 to 2000ppm	0 to 2600mg/m ³	0 to 5600mg/m ³	0 to 2500mg/m ³
U	0 to 2500ppm	0 to 3300mg/m ³	0 to 7100mg/m ³	0 to 3000mg/m ³
T	0 to 3000ppm	0 to 4000mg/m ³	0 to 8500mg/m ³	0 to 3750mg/m ³
H	0 to 5000ppm	0 to 6600mg/m ³	0 to 14.00g/m ³	0 to 6250mg/m ³

List of measurable components and ranges

Fabrication is possible under the condition that the range ratio of the first to the second is 1 to 10 or less.

For details of measuring range, refer to specifications (EDS3-133).

1-component analyzer

Measurable gas components	1st range		2nd range	
	Minimum range	Maximum range	Minimum range	Maximum range
NO	0 to 200ppm	0 to 5000ppm	0 to 250ppm	0 to 5000ppm
SO ₂	0 to 200ppm	0 to 10%	0 to 250ppm	0 to 10%
CO	0 to 200ppm	0 to 100%	0 to 250ppm	0 to 100%
CO ₂	0 to 100ppm	0 to 100%	0 to 200ppm	0 to 100%
CH ₄	0 to 500ppm	0 to 100%	0 to 1000ppm	0 to 100%

2-component analyzer

NO+SO₂

Measurable gas components	1st range		2nd range	
	Minimum range	Maximum range	Minimum range	Maximum range
NO	0 to 200ppm	0 to 5000ppm	0 to 250ppm	0 to 5000ppm
SO ₂	0 to 200ppm	0 to 5000ppm	0 to 250ppm	0 to 5000ppm

NO+CO

Measurable gas components	1st range		2nd range	
	Minimum range	Maximum range	Minimum range	Maximum range
NO	0 to 200ppm	0 to 5000ppm	0 to 250ppm	0 to 5000ppm
CO	0 to 200ppm	0 to 5000ppm	0 to 250ppm	0 to 5000ppm

CO₂+CO

Measurable gas components	1st range		2nd range	
	Minimum range	Maximum range	Minimum range	Maximum range
CO ₂	0 to 100ppm	0 to 100%	0 to 200ppm	0 to 100%
CO	0 to 200ppm	0 to 100%	0 to 250ppm	0 to 100%

CH₄+CO

Measurable gas components	1st range		2nd range	
	Minimum range	Maximum range	Minimum range	Maximum range
CH ₄	0 to 500ppm	0 to 100%	0 to 1000ppm	0 to 100%
CO	0 to 200ppm	0 to 100%	0 to 250ppm	0 to 100%

CO₂+CH₄

Measurable gas components	1st range		2nd range	
	Minimum range	Maximum range	Minimum range	Maximum range
CO ₂	0 to 100ppm	0 to 100%	0 to 200ppm	0 to 100%
CH ₄	0 to 500ppm	0 to 100%	0 to 1000ppm	0 to 100%

3-component analyzer

NO+SO₂+CO

Measurable gas components	1st range		2nd range	
	Minimum range	Maximum range	Minimum range	Maximum range
NO	0 to 200ppm	0 to 5000ppm	0 to 250ppm	0 to 5000ppm
SO ₂	0 to 200ppm	0 to 5000ppm	0 to 250ppm	0 to 5000ppm
CO	0 to 200ppm	0 to 5000ppm	0 to 250ppm	0 to 5000ppm

CO₂+CO+CH₄

Measurable gas components	1st range		2nd range	
	Minimum range	Maximum range	Minimum range	Maximum range
CO ₂	0 to 5000ppm	0 to 100%	0 to 1%	0 to 100%
CO	0 to 500ppm	0 to 100%	0 to 1000ppm	0 to 100%
CH ₄	0 to 5000ppm	0 to 100%	0 to 1%	0 to 100%

4-component analyzer

NO+SO₂+CO₂+CO

Measurable gas components	1st range		2nd range	
	Minimum range	Maximum range	Minimum range	Maximum range
NO	0 to 200ppm	0 to 5000ppm	0 to 250ppm	0 to 5000ppm
SO ₂	0 to 200ppm	0 to 5000ppm	0 to 250ppm	0 to 5000ppm
CO ₂	0 to 1%	0 to 50%	0 to 2%	0 to 50%
CO	0 to 200ppm	0 to 2500ppm	0 to 250ppm	0 to 2500ppm

• Major specifications

Measurement principle	NO, SO ₂ , CO, CO ₂ , CH ₄ : Non-dispersive infrared ray absorption (Single-beam system) O ₂ : Fuel cell (built in) or zirconia (externally installed ZFK7 by Fujii) or Paramagnetic (built in)		
Measurable component and range	Measured component	Minimum range	Maximum range
	NO	0-200ppm	0-5000ppm
	SO ₂	0-200ppm	0-10 vol%
	CO ₂	0-100ppm	0-100 vol%
	CO	0-200ppm	0-100 vol%
	CH ₄	0-500ppm	0-100 vol%
	O ₂	0-10 vol%	0-25 vol%
	Fuel cell (built in)		
	O ₂ Zirconia Paramagnetic O ₂ sensor	0-5 vol%	0-25 vol%
Repeatability	Switching between 2 ranges allowed for each component. Maximum range ratio: 1:10 (excluding O ₂)		
Linearity	±0.5% FS		
Zero drift	±1.0% FS		
Span drift	Within ±2%FS/week		
Response time	Within 60 sec (90% response from gas inlet) Varies depending on the components to be measured and the measurement range.		
Analog output signal	4 to 20 mA or 0 to 1 VDC (12 points at max.) Instantaneous value output (Concentration of each gas component measured) Option: O ₂ correction instantaneous value output, O ₂ correction average output, O ₂ average output		
Display	LCD with backlight (Japanese, English or chinese by designation) Instantaneous value of each component, O ₂ correction instantaneous value. O ₂ correction average, O ₂ average, parameter setting, with auto OFF function		
Range switching	Manual switching by key operation, auto switching, external contact input switching (option)		
External digital input (option)	Voltage contact (supply 12 to 24 VDC/15 mA max. at ON) 9 points at max. Range switching, auto calibration start, output signal hold, average value reset		

Contact output function (option)	1c relay contact (15 points at max.) Identification of each component range, instrument failure, calibration error, auto calibration in progress, upper/lower limit alarm for each component, solenoid valve drive for auto calibration
Communication function (option)	RS-485 (MODBUS protocol) Details of communication: Read/write of each setting, output of measured concentration and instrument status Type-B with USB connector (front face) and USB driver
Sample gas flowmeter	Built in
Gas outlet/inlet dimension	Rc1/4 or NPT1/4
Purge gas flow rate	1 L/min (Performed as required.)
Structure	Indoor type with steel case
Ambient temperature/humidity	-5°C to 45°C, 90 RH or lower (No condensation allowed.)
Mounting method	19" rack mount, panel mount, desktop
Power supply voltage	100 to 240 VAC, 50/60 Hz, 100VA
Outside dimension	133×483×418 mm (19" rack mount) 133×440×418 mm (Panel mount)
Mass	Approximately 8 kg (5-component analyzer)
Applicable standard	CE mark

<Measured gas conditions>

Flow rate	0.5L/min±0.2L/min
Temperature	0°C to 50°C
Pressure	10 kPa or lower
Dust	100 µg/Nm ³ or lower (Particle size: 0.3 µm or smaller)
Mist	Not allowed.
Moisture	Saturation at room temperature or lower (No condensation allowed.) Saturation at 2°C or lower (No condensation allowed.)
Corrosive component	HCl: 1 ppm or less

• Outline diagram (Unit: mm)

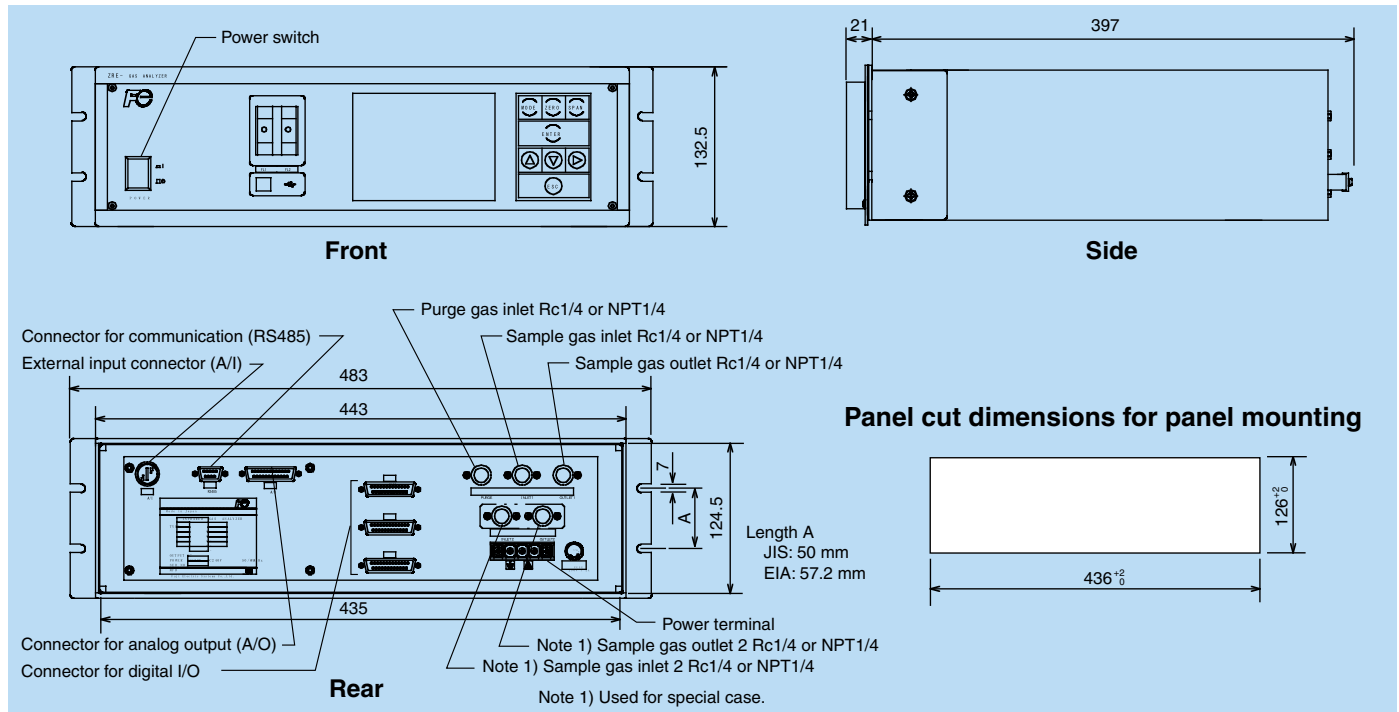

FE Fuji Electric Co., Ltd.

Global Sales Section

Instrumentation & Sensors Planning Dept.

1, Fuji-machi, Hino-city, Tokyo 191-8502, Japan

<http://www.fujielectric.com>

Phone: +81-42-514-8930 Fax: +81-42-583-8275

<http://www.fujielectric.com/products/instruments/>